

RAYMOND

JOHNSTON EQUIPMENT



YOUR COMPLETE SOLUTIONS™ **STORAGE** CATALOGUE



SEE INSIDE FOR THESE NEW PRODUCTS!

Knocked-Down Self-Dumping Hoppers

Page B21

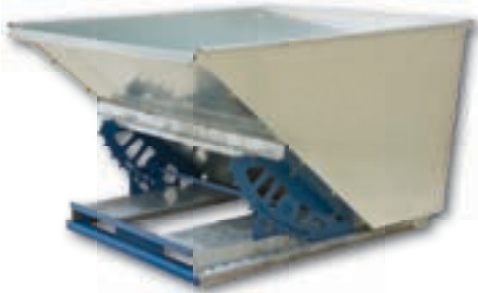

KLETON

Ready To Assemble Steel Lockers

Page B103

KLETON



Reinforced Design Stack & Hang Bins

Page B129

KLETON



Collapsible Bulk Container

Page B153



KLETON

Utility Grade Duct Tape

Page B157



KLETON

Fasteners & Tapes

Page B162



VELCRO®

Rollable Containers

Page B170



Produits D'Entretien
RMP
Maintenance Products

Heavy-Duty Oscillating Fans

Page B184



MATRIX
INDUSTRIAL PRODUCTS

Foam Ear Plugs

Page B228

ZENITH
Safety Products



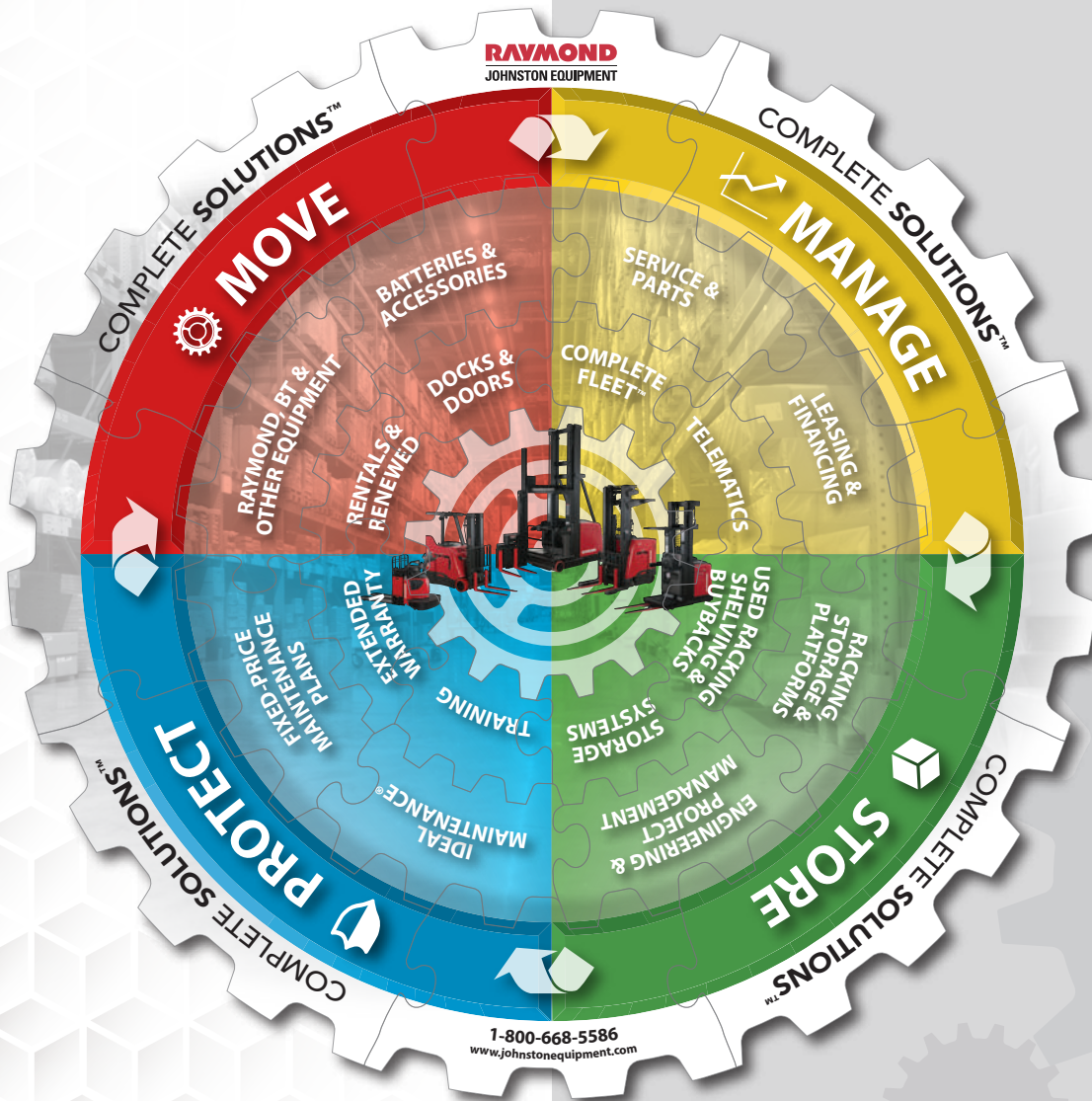

JOHNSTON EQUIPMENT
Overview

Visit us at www.johnstonequipment.com

When you need to **move**, **manage**, **store** and **protect**™ goods, Johnston Equipment's Complete Solutions™ will help you to **Run Better. Manage Smarter.**™



Selective Rack

Visit us at www.johnstonequipment.com

OPERATIONAL CONSIDERATIONS

- Advantageous for high SKU counts, with pallet in/pallet out or pallet in/ case out movements
- Excellent selectivity, improved productivity - every pallet has a facing
- Flexible - no specialized lift trucks required
- Maintains FIFO (First in, First Out)
- Reduced product damage versus bulk stacking

SPACE UTILIZATION EFFICIENCIES

- Considerable savings over bulk floor stacking of pallets by using available height





Double Deep Rack

Call us at 1.800.668.5586

OPERATIONAL CONSIDERATIONS

- Advantageous for low to medium SKU counts, with pallet in/pallet out movements
- Selectivity reduced 50% vs. Single Selective Rack
- Utilizes deep reach lift trucks
- Modified FIFO (First In, First Out)

SPACE UTILIZATION EFFICIENCIES

- May improve cube utilization by up to 40%
- May be retrofitted to existing single selective rack systems





Drive-In Rack

Visit us at www.johnstonequipment.com

OPERATIONAL CONSIDERATIONS

- Advantageous for low SKU counts, with medium to high activity and pallet in/pallet out movements
- Flexible - uses counterbalanced lift trucks or reach trucks
- Maintains LIFO (Last In, First Out)

SPACE UTILIZATION EFFICIENCIES

- Improved cube utilization by up to 40% vs. Selective Rack





VNA Rack

VERY NARROW AISLE

Call us at 1.800.668.5586

OPERATIONAL CONSIDERATIONS

- Advantageous for high SKU counts, with pallet in/pallet out movements
- 100% pallet selectivity – can pick cases at elevated levels with order picker truck
- Utilizes specialized VNA lift trucks
- FIFO (First in, First out)

SPACE UTILIZATION EFFICIENCIES

- Aisle space reduced by 34% or more vs. single Selective Rack
- Reduced product and rack damage
- Improved pick rates
- Improved cube utilization through increased storage height



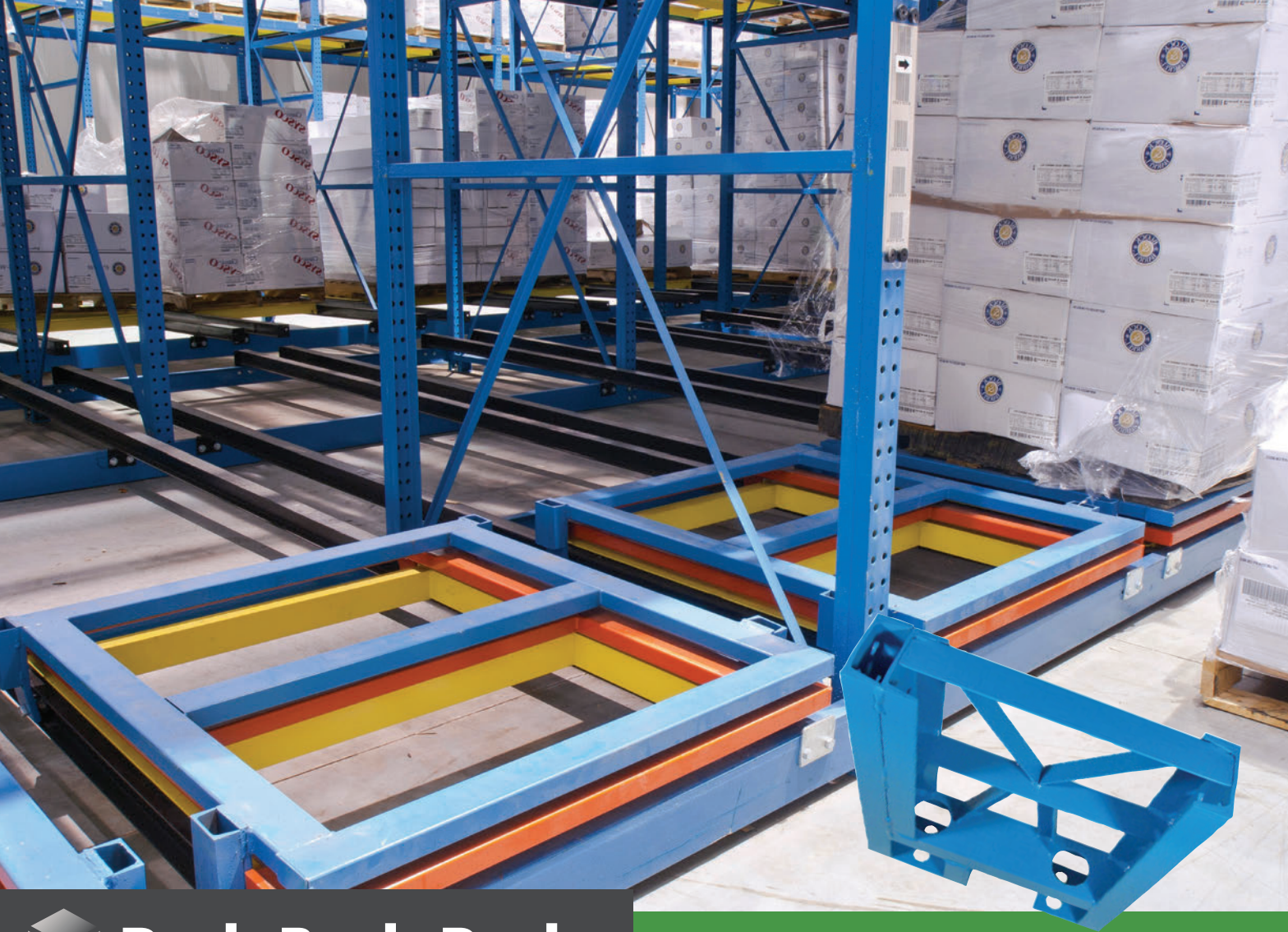

Push Back Rack

Visit us at www.johnstonequipment.com

OPERATIONAL CONSIDERATIONS

- Advantageous for medium to high SKU counts, with medium to high activity and pallet in/pallet out movements
- Flexible - suitable for use with either counterbalanced or reach lift trucks
- All pallets are accessed from the aisle
- Typically LIFO (Last In, First Out) within the lane
- Modified FIFO (First In, First Out) is possible.

SPACE UTILIZATION EFFICIENCIES

- Improved cube utilization
- While footprint is similar to Drive-In, utilization rates tend to be higher, resulting in even better space savings





Pallet Flow Rack

Call us at 1.800.668.5586

OPERATIONAL CONSIDERATIONS

- Advantageous for low SKU counts, with high activity and pallet in/pallet out movement, where strict FIFO (First In, First Out) is required
- Eliminates lift truck contention by segregating picking and replenishment functions
- Flexible - suitable for use with either counterbalanced or reach lift trucks
- FIFO (First in, First out)

SPACE UTILIZATION EFFICIENCIES

- Variable Pallet Flow lane depths
- Improved cube utilization





Radio Shuttle

HIGH DENSITY, SEMI-AUTOMATED

Visit us at www.johnstonequipment.com

OPERATIONAL CONSIDERATIONS

- High Density Semi-Automated Storage and Retrieval System
- Intelligent carts store and retrieve pallets, as instructed by operator using remote-controlled radio transmitter
- Carts are easily transferred between lanes with a lift truck
- Can be utilized with customer's existing WMS (*Warehouse Management System*)
- Can be integrated with other rack systems or with fully automated storage and retrieval systems
- Advantageous for low SKU counts, with high activity and pallet in/pallet out movement
- Flexible – suitable for use with either counter-balanced or reach lift trucks
- Powered by light weight lithium ION battery packs
- Standard lift capacity of 3,400
- Suitable for ambient, cooler and freezer applications
- Can be configured for either FIFO (First In, First Out) LIFO (Last In, First Out) applications

SPACE UTILIZATION EFFICIENCIES

- The most space efficient pallet storage product available
- Variable pallet lane depths





Cantilever Rack

Call us at 1.800.668.5586

OPERATIONAL CONSIDERATIONS

- Typically suited to items such as building materials, piping, rolls, furniture and sheet goods
- Arms are adjustable to suit product spacing requirements
- Can be configured as single-sided or double-sided use
- Flexible - suitable for use with counter-balanced or reach lift trucks
- Narrow aisle applications are possible with the use of 4-Directional lift trucks

SPACE UTILIZATION EFFICIENCIES

- Considerable savings over bulk floor stacking
- Higher ceiling heights provide greater savings
- The most effective way to store long, bulky products
- Improved throughputs





Carton Flow

Visit us at www.johnstonequipment.com

OPERATIONAL CONSIDERATIONS

- Ideal for full case and split case picking
- Improved pick rates
- Separates replenishment from picking activity, eliminating contention
- Can be integrated within standard pallet rack, allowing replenishment pallet storage above
- Can be implemented as a stand-alone system in various heights and widths
- Can be integrated with gravity conveyor and power conveyor
- Available in many styles to suit each customer's unique product characteristics
- Ideal for use within Pick Modules

SPACE UTILIZATION EFFICIENCIES

- High concentration of SKU's
- Ergonomic pick design
- Allows appropriate inventory at pick location





Mezzanines RAISED STORAGE PLATFORMS

Call us at 1.800.668.5586

OPERATIONAL CONSIDERATIONS

- Multi-functional - use with standalone shelving, carton flow and wide span shelving or as production space
- Wide spans with minimal column interference at lower levels
- Multiple flooring options are available including concrete, bar grating, plywood, Polydeck, Resindek®, etc
- May be engineered for cart and pump truck traffic
- Customizable
- May be dismantled and relocated
- Engineered to meet all national and local building codes

SPACE UTILIZATION EFFICIENCIES

- Optimal use of building cube
- Double and even triple floor space while leaving ground floor for lift truck/production use





VERTICAL LIFT MODULE (VLM)

The Kardex Remstar Shuffle XP Vertical Lift Module is an enclosed system of vertically arranged trays stored on both sides of the unit with an extractor device placed in the centre. The VLM automatically delivers trays with the stored items to the access window with a push of a button or a scan of a barcode. The device is modular in construction allowing the height and number of access windows to be adjusted pre and post construction. Depending on the usable building interior heights, up to 85% of conventional storage systems occupied floor space may be recovered. Using CubeStar® technology, the shuffle VLM automatically scans the height of the product on each tray and finds ideal storage location within the unit. Trays are stored in one inch (25 mm) increments using the least amount of space and maximizing the storage density within the unit.

VERTICAL CAROUSEL

Vertical Carousel Shelves or drawers rotate up or down via the shortest path, automatically delivering stored items to an operator at an ergonomically positioned pick window. Each unit is compatible with an entire suite of software and controls or can be used as a standalone solution. Utilizing the goods to person concept eliminates the wasted time spent walking and searching to find required parts. With the Megamat RS Vertical carousel all products are delivered to the work station, increasing productivity up to 2/3.



Carousels
VERTICAL & HORIZONTAL

Visit us at www.johnstonequipment.com



kardexremstar
authorized distributor

HORIZONTAL CAROUSEL

The horizontal carousel eliminates unproductive travel and search times using software controlled picking sequences to deliver store goods efficiently to the operator, speeding up picking times and increasing throughput. Combined with pick to light technology; the operator is directed to the exact location of each pick improving accuracy rates to 99.9%. The Kardex Remstar horizontal carousels consist of an oval track supporting rotating bins with shelves that deliver stored goods to the operator.

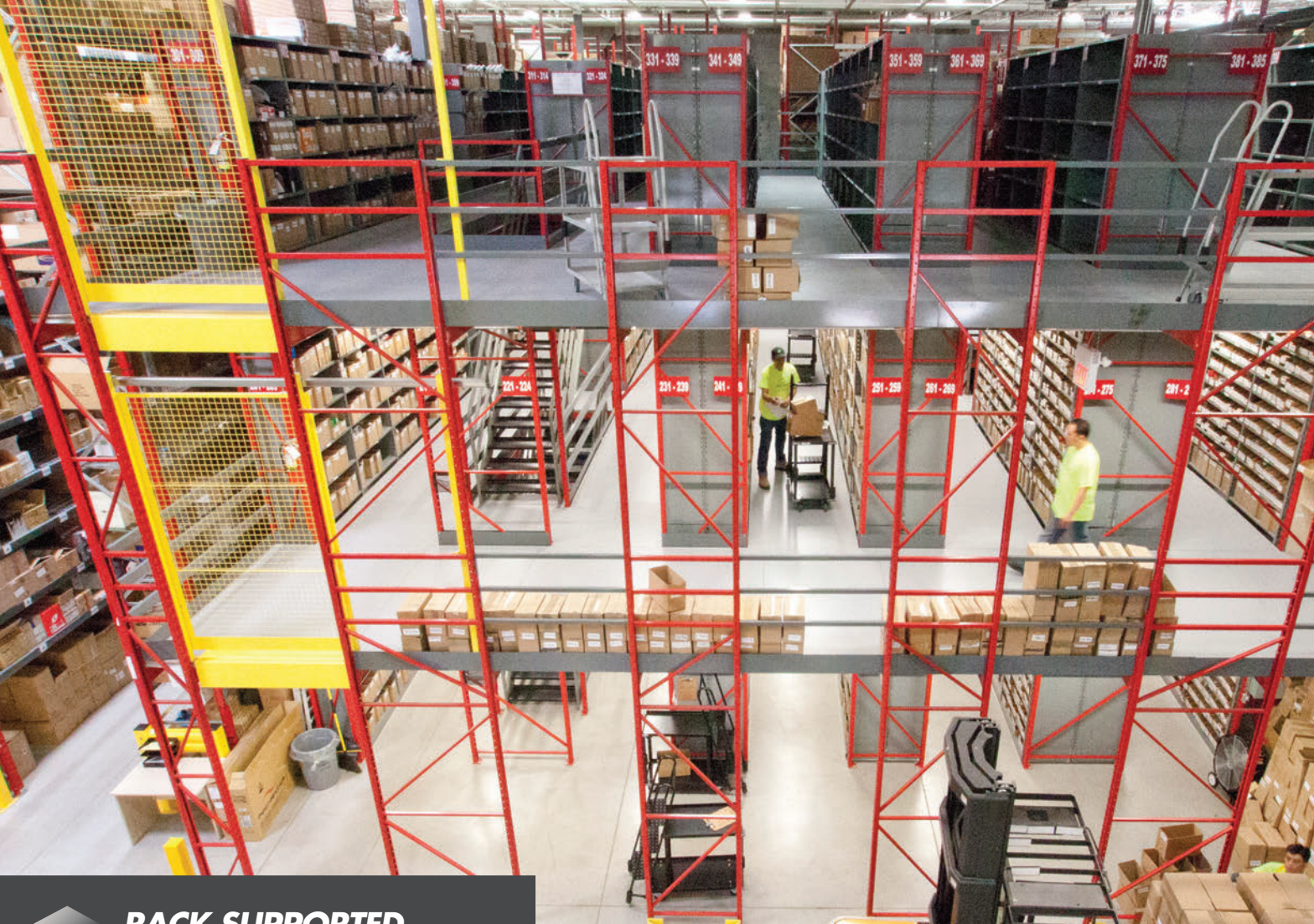

RACK SUPPORTED Mezzanine

Call us at 1.800.668.5586

OPERATIONAL CONSIDERATIONS

- Ideal for operations with a high number of SKUs involving small parts storage and piece pick operations
- Typical industries serviced are automotive & truck parts, farm machinery, service & maintenance, hardware, etc
- Gravity and powered conveyor can be incorporated to enhance throughput
- Can incorporate security panels for high value items or controlled product storage
- Multi-level systems can be built to suit the customer's specific needs
- Engineered to conform to all national and local building codes

SPACE UTILIZATION EFFICIENCIES

- Can greatly reduce storage footprint for small parts storage by utilizing the full height of the building
- Space freed up can be used for other storage products or production work space
- Increases pick efficiency and throughput by concentrating piece pick operations to a smaller area





Interlok No-Bolt Shelving

OPERATIONAL CONSIDERATIONS

- Ideal for medium case and piece pick applications
- Heavy Duty industrial steel shelves
- Boltless shelves – special clips allow quick adjustment of shelf heights
- Baked enamel finish: many colours available
- Shelf widths typically are 36" or 48"

SPACE UTILIZATION EFFICIENCIES

- Simple, basic way of storing and organizing products
- Reconfigurable for changing storage requirements
- Improved cube utilization in high-bay applications



Visit us at www.johnstonequipment.com



Wide Span Shelving

OPERATIONAL CONSIDERATIONS

- Fast, easy assembly
- Ideal for records storage, retail and grocery applications
- Can be fitted with wire mesh decks, steel decks wood decks, or drop-in-panels
- Great for hand stacking operations
- Beams are easily adjusted to suit product heights
- Bay widths typically 48", 72" or 96" wide

SPACE EFFICIENCIES

- Simple, basic way of storing and organizing products
- Reconfigurable for changing storage requirements
- Improved cube utilization in high-bay applications





Rack Protection and Guarding



Safety & Security



Security Cages & Partitions

Wire Mesh Decks

Turn racks into high capacity shelves instantly. They can also be used as an alternative to safety bars.



Row End Protectors

This sturdy design is not only strong, but highly visible, reducing the risk of contact. We have many styles and options from which to choose.



Protect-It™

Is an innovative, super-tough rack protection device made of advanced thermoplastic. It's easy to install and is available in a wide range of sizes to suit most rack types.



Safety Bars

Add an extra measure of protection for improperly placed loads. Safety bars help prevent pallets from falling through the beams



Safety Netting

Safety netting helps prevent cartons and packages from falling onto workstations, conveyor systems and pedestrian walkways.



Available in many sizes and strengths to suit a variety of horizontal or vertical applications.

MOVE



RAYMOND, BT AND OTHER EQUIPMENT

Increase efficiency and lower costs throughout your material handling operations with top-notch quality and a reliable range of equipment options.

BATTERIES & ACCESSORIES

We bring together the quality, selection, warranty, service and pricing of Canada's top battery suppliers - including end-of-life battery programs.

RENTALS & RENEWED

Accommodate for peak periods and seasonality through our **Ready. Right. Now.**TM rentals and/or optimize your fleet and costs with quality, cost-effective **Raymond RENEWED**TM equipment.

DOCKS & DOORS

Maximize productivity and cost management by relying on a single provider for service and reporting.

MANAGE



PARTS & SERVICE

Quick access to over 7 million parts for any make and model of forklift, and guaranteed service on all brands.

LEASING & FINANCING

Reduce your total cost of ownership, while improving your fleet flexibility, to help you grow and manage your business both now and in the future.

COMPLETE FLEET[®]

Ensures consistent, quality service on all makes and models in your fleet, along with increased visibility into your equipment's total cost of ownership.

TELEMATICS

Experience unprecedented visibility into the efficiency of your material handling fleet, and the efficacy of your operators, with **iWAREHOUSE**[®] - all conveniently viewable through a single web portal.

STORE



RACKING STORAGE & PLATFORMS

Optimize your warehouse to increase pallet positions, maximize throughput and reduce labor costs, all delivered with exceptional manufacturing quality and service.

ENGINEERING AND PROJECT MANAGEMENT

Innovative, flexible, tailored solutions designed and implemented to the highest quality, safety and legislative standards.

USED RACKING-SHELVING & BUYBACKS

A cost-effective alternative when adding to an existing system or opening up new storage space in your warehouse. We can also help you clear out excess shelving.

STORAGE SYSTEMS

Use floor space more efficiently, increase order selection productivity and improve workplace ergonomics at the total lowest operational cost.

PROTECT



IDEAL MAINTENANCE[®]

Equipment maintenance that has been optimized for quality, speed and safety, **Ideal Maintenance** delivers unparalleled service consistency across our national technician base.

FIXED-PRICE MAINTENANCE PLANS

Enjoy the benefits of our **Ideal Maintenance** service program while stabilizing your lift truck maintenance costs across your entire fleet.

TRAINING

The only nationally-accessible, accredited comprehensive operator training programs to create consistency across an employee base that is small, large or anywhere in between; delivered through convenient in-person and online formats.

EXTENDED WARRANTY

The best factory protection and service for your new truck, with double the power train protection.

RAYMOND
JOHNSTON EQUIPMENT

RUBBER WHEEL HAND TRUCKS

- Constructed of 1", 16-gauge steel tubing
- Nose plate 7-gauge steel
- Overall width: 19 1/2"
- Wheel dimensions: 8" x 2"
- Powder-coated



KLETON

Model No.	Description	Overall Height	Nose Plate Dim. W" x D"	Capacity lbs.	Wt. lbs.
MK728	Continuous Handle	46	14 x 8 1/2	600	23
MK729	Dual Handle	48	14 x 8 1/2	600	24
MN103	P-handle	51	600	24	



PNEUMATIC WHEEL HAND TRUCKS

- Constructed of 1", 16-gauge steel tubing
- Nose plate 8-gauge steel
- Overall width: 21 1/2"
- Wheel dimensions: 10" x 3"
- Powder-coated



KLETON

Model No.	Description	Overall Height	Nose Plate Dim. W" x D"	Capacity lbs.	Wt. lbs.
MH300	Dual Handle	46	14 x 9	600	20
MH301	Continuous Handle	48	14 x 9	600	22
MH302	P-handle	51	14 x 9	600	22



FLAT FREE WHEEL HAND TRUCKS

- Constructed of 1", 16-gauge steel tubing
- Nose plate 8-gauge steel
- Overall width: 22"
- Wheel dimensions: 10" x 3 1/2"
- Powder-coated



KLETON

Model No.	Description	Overall Height	Nose Plate Dim. W" x D"	Capacity lbs.	Wt. lbs.
MN389	Dual Handle	46	14 x 9	600	20
MN390	Continuous Handle	48	14 x 9	600	22
MN391	P-Handle	51	14 x 9	600	22



HEAVY-DUTY HAND TRUCKS

- All welded construction
- Constructed of 1 1/4", 14 gauge steel tube
- Nose plate 6-gauge steel
- Overall Width: 20"
- Powder-coated paint
- Durable Kleton blue enamel finish



KLETON

Model No.	Description	Overall Height	Nose Plate Dim. W" x D"	Capacity lbs.	Wt. lbs.
10" X 3" PNEUMATIC WHEELS					
MK731	Dual Handle	46	14 x 8	800	36
M0120	Continuous Handle	50	14 x 8-3/4	800	28
M0122	P-Handle	50-3/4	14 x 8-3/4	800	29
8" X 2" MOLD-ON RUBBER WHEELS					
MK730	Dual Handle	46	14 x 8	1000	36
M0119	Continuous Handle	50	14 x 8-3/4	1000	28
M0121	P-Handle	50-3/4	14 x 8-3/4	1000	29



HAND TRUCKS

HEAVY-DUTY SPADE TRUCKS

- All welded, ready to use
- Constructed of double-welded 1 1/4" round 14-gauge steel tubing
- Oversized nose plate and easy grip frame helps with the balancing of larger items
- Tapered 22" L x 13" D x 1/4" thick nose plate
- Two 10" mold-on rubber wheels
- Capacity: 1200 lbs.
- Durable Kleton blue enamel finish

KLETON

K
CUSTOM

Model No	Dimensions W" x H"	Wt. lbs.
ML324	22" x 53"	92



APPLIANCE TRUCKS

- Move large appliances easily
- Heavy-duty all welded industrial construction
- Vinyl bumpers on face of truck to prevent damage to appliances
- Heavy-duty continuous stair climbers for easy climbing/descending
- 8" solid rubber wheels
- Ratchet mechanism for easy fastening of loads
- Overall dimensions: 14 1/2" L x 24" W x 59" H
- Capacity: 550 lbs.
- Weight: 46 lbs.

Model No. ML616

KLETON



VENDING MACHINE APPLIANCE TRUCKS

- Move large appliances easily
- Heavy-duty all welded industrial construction
- Vinyl bumpers on face of truck to prevent damage to appliances
- Heavy-duty continuous stair climbers for easy climbing/descending
- Fold out rear legs with two 4" swivel casters
- 8" solid rubber front wheels
- Ratchet mechanism for easy fastening of loads
- Overall dimensions: 14 1/2" L x 24" W x 66" H
- Capacity: 850 lbs.
- Weight: 65 lbs.

Model No. ML617

KLETON



MOVING STRAPS

- Allows for safe movement of appliances and larger items
- Movers can constantly stay in an upright position during the move, reducing the risk of back injuries
- Nylon (5000 lbs. test)
- **Includes:** Two transport straps, 4" x 4", and two adjustable straps, 1 3/4" x 9'

Model No. MD223



HEAVY-DUTY DUAL HANDLE HAND TRUCKS

- Constructed of 1 1/4", 14-gauge steel tubing
- Nose plate 6-gauge steel
- Overall height: 46"
- Overall width: 20"
- 8" x 12" nose plate
- Powder-coated

KLETON

K
CUSTOM

Model No.	Description	Wheel"	Capacity lbs.	Wt. lbs.
MA376	Rubber Wheel	10 x 2	1000	40



DELUXE 12" NOSE PLATE HAND TRUCKS

- All welded, ready to use
- Constructed of 1" round 14-gauge steel tubing
- Transport short to tall loads easily
- P handle ideal for one hand control
- Strong 12" L x 14" D x 3/16" thick nose plate
- Double welded 3/16" x 1 1/2" cross bars
- Add a folding nose extension to be able to transport larger loads
- Two 10" full pneumatic wheels
- Capacity: 700 lbs.
- Durable Kleton blue enamel finish

ML321

ML322

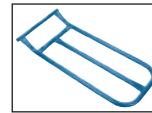

ML323
Nose Extension

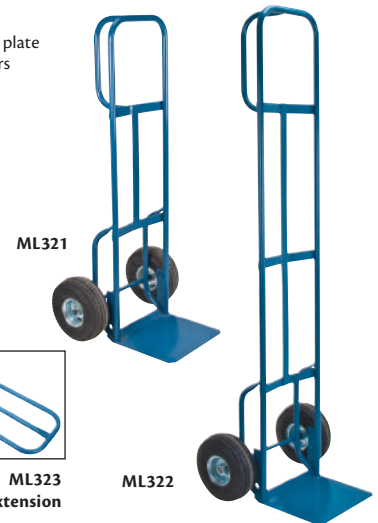

KLETON

Model No	Description	Overall Dimensions		Wt. lbs.
		W"	H"	
ML321	Lo-Boy	23	50	40
ML322	Hi-Boy	23	72	46
ML323	Nose Extension	12"	22" D	8

CONVERTIBLE DELUXE STEEL HAND TRUCKS

- Constructed of 1" round 14-gauge steel tubing
- Quickly converts from a 2-wheel hand truck to a 4-wheel platform truck
- 8" x 14" nose plate
- Comes with two welded-on stair glides
- Two 10" full pneumatic wheels and two 3" bolted-on casters
- Capacity: Hand truck 600 lbs.
Platform truck 800 lbs.
- Durable Kleton blue enamel finish



KLETON

K
CUSTOM

Model No	Overall Dimensions W" x D" x H"	Wt. lbs.
ML320	14 x 43 x 46	75

HAND TRUCKS WITH SWIVEL CASTERS

- 4" rear poly casters allow small diameter turns in tight areas
- Combination two handle and utility bar design reduces strain of lifting, lowering and transporting
- 8" deep nose plate
- 10" x 2 3/4" semi-pneumatic front wheels
- Overall dimensions: 20 1/2" W x 47 1/2" H
- Capacity: 800 lbs.
- Weight.: 53 lbs.

Model No. MD758



WESCO

LIFTKAR® ALUMINUM STAIR CLIMBING HAND TRUCKS

- Battery-powered stair climbing hand trucks help reduce worker fatigue and the risk of injury, as well as reduce the number of employees needed to deliver cargo
- Pivoting and fixed ergonomic handle configurations available to handle a wide variety of cargo
- Lift wheels are uni-directional to help prevent cargo from accidentally rolling down the stairs
- Dual speed control on all models to fit your application
- Electronic overload protection protects operating components if capacity is exceeded
- 10" pneumatic wheels
- Capacity: 375 lbs.
- Quick-change battery and charger included
- **Nose plates sold separately**



Ergo frame



Fold frame



Uni frame



Fold-L frame



Model No.	Frame Type	Dimensions		
		W"	x	H"
MN247	Ergo	18 1/2	x	63
MN248	Fold	18	x	61 (40 Folded)
MN249	Uni	17 1/2	x	59
MN250	Fold-L	19	x	64 1/2 (51 Folded)

NOSE PLATES

Model No.	Frame Type	Dimensions		
		W"	x	H"
MN727	Grooved	16.5	x	13.4
MN728	Grooved	18.8	x	9.4
MN729	Smooth	18.45	x	10.9
MN730	Smooth	18.74	x	9.4
MN731	Smooth	17.7	x	7.5
MN732	Grooved	14	x	7
MN733	Grooved	23.25	x	7

Note: Each unit is capable of being customized with various options (i.e. wheel type and nose plate size). Also available in 240-lb. and 300-lb. capacities.

THREE-POSITION SPARTAN III™ CONVERTIBLE HAND TRUCKS

- Can be used to transport all your needs, from general use items to bulky equipment
- 3 Positions: Vertical - 2 wheel, 45 Degree - 4 wheel, Platform - 4 wheel
- 7.5" W x 27" L recessed folding nose extension
- Handle type: Continuous handle
- Handle height: 48"
- 5" x 1.25 swivel casters
- 10" pneumatic wheels
- Capacity vertical 2 wheel: 500 lbs.
- Capacity 45 degree 4 wheel: 500 lbs.
- Capacity 4 wheel Platform: 750 lbs.
- Frame bed: 12" W x 51" L
- Shipped knocked down, boxed



Model No.	Frame Material	Nose Plate Dimensions W" x D"	Overall Dimensions		Colour	Wt. lbs.
			W" x H"			
MN680	Aluminum	18 x 7.5	21.5 x 52		Aluminum	42

LOAD RETENTION HAND TRUCKS

- Constructed of 1" round 14-gauge steel tubing
- 18 1/2" x 53" load retention grill to safely handle wide and awkward loads
- 7-gauge steel nose plate
- 18 1/2" W x 9 3/4" D nose plate
- Two 10" full pneumatic wheels
- Capacity: 600 lbs.
- Durable Kleton blue enamel finish

Model No. MN412



GEMINI® CONVERTIBLE ALUMINUM TRUCKS



- Converts in seconds from a 2-wheel hand truck to a 4-wheel platform truck
- Lightweight, high strength aluminum construction
- Balanced to assure easier wheeling and positive load control
- 18" wide x 7 1/2" deep rugged cast aluminum nose plate
- 5" swivel casters
- 10" x 3 1/2" full pneumatic wheels
- 16 5/8" frame width, 20 1/2" O.A. width
- Shipped knocked down



Gemini Jr.



Gemini Sr.

Model No.	Hand Truck		Platform Truck		Length"	Wt. lbs.
	Cap. lbs.	Ht."	Cap. lbs.	Ht."		
MA319	500	51	1000	40	38	44
MA320	500	61	1000	45 1/8	51	45

OPTIONAL SNAP-ON DECK

MB198	43 1/4" For Gemini Jr.	5
MB197	56" For Gemini Sr.	6

SPARTAN ALUMINUM ECONOMY CONVERTIBLE TRUCKS

- Converts easily from 2-wheel to 4-wheel
- 10" pneumatic wheels & 5" casters
- Frame Material: Aluminum
- Nose Plate Dimensions: 18" W x 7-1/2" D
- Hand Truck Capacity: 500 lbs.
- Platform Truck Capacity: 1000 lbs.
- Shipped knocked down



MH257

Model No.	Description	Size"
MH257	Jr.	52
MH258	Sr.	61-1/2

HAND TRUCKS

RUBBER WHEEL ALUMINUM HAND TRUCKS

- Strong lightweight hand truck provides exceptional durability and versatility
- Weld-free construction for easy maintenance
- Wheel Size: 8" H x 2" W
- Capacity: 500 lbs.
- Shipped knocked down



KLETON



Model No.	Wheel Material	Overall Dimensions		Nose Plate Dimensions		
		W"	H"	W"	x	D"
P-HANDLE						
MO073	Rubber	14	52	14	x	7-1/2
MN027	Mold-On Rubber	21	48	18	x	7-1/2
CONTINUOUS HANDLE						
MN024	Mold-On Rubber	16	48	14	x	7-1/2
MN025	Mold-On Rubber	20	48	18	x	7-1/2

FOLDING HAND TRUCK

- Lightweight and durable aluminum construction
- Convenient folding construction permits storage in small spaces
- Comfortable ergonomic handle
- Elastic straps help to secure load
- 5" x 1 1/4" non-marking and shock-absorbing rubber wheels
- 15 1/4" W x 11" D nose plate
- Capacity: 175 lbs.
- Overall Dimensions: 15-1/2" W x 39-5/8" H
- Weight: 9 lbs.

Model No. ML447



KLETON

CONVERTIBLE HAND TRUCKS

- Lightweight aluminum construction
- Converts easily from a 2-wheel hand truck to a 4-wheel platform truck
- 5" polyurethane casters and 10" flat free wheels
- Shipped assembled

KLETON

Model No.	Nose Plate W" x D"	Hand Truck		Platform Truck		Wt. lbs.
		Cap. lbs.	Height"	Cap. lbs.	L" x W"	
ML621	18 x 10	600	52	1250	12 x 43	54
MO068	18 x 7-1/2	550	62	800	56 x 20	42



HAND TRUCK ACCESSORIES

KLETON

FRAME EXTENSIONS

- Size: 17"
Model No. MN021
- Size: 23"
Model No. MN022



MN021



MN022

STAIR CLIMBERS

Model No. MN015



MN015

NOSE EXTENSIONS

- Size: 20"
- Will not fit on 18" x 10" nose plates.

Model No. MN019

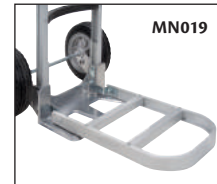

MN019

REPLACEMENT WHEELS

- 10" Pneumatic
Model No. MN012
- 8" Mold-on rubber
Model No. MN013
- 10" Flat-free
Model No. MN014



MN012



MN014



MN013

FLAT-FREE WHEEL ALUMINUM HAND TRUCKS

- Strong lightweight hand truck provides exceptional durability and versatility
- Weld-free construction for easy maintenance
- Wheel Size: 10" H x 3" W
- Capacity: 500 lbs.
- Shipped knocked down



Model No.	Handle Type	Overall Dimensions			Nose Plate Dimensions		
		W"	x	H"	W"	x	D"
MN034	Continuous	16	x	48	14	x	7-1/2
MO080	P-handle	18	x	52	18	x	7-1/2
MO078	Continuous	14	x	48	14	x	7-1/2
MO077	Continuous	18	x	48	18	x	10

Model No.	Handle Type	Overall Dimensions			Nose Plate Dimensions		
		W"	x	H"	W"	x	D"
MO075	Continuous	14	x	52	14	x	7-1/2
MO072	Dual Handle	18	x	52	18	x	7-1/2
MN032	Dual Handle	18	x	52	18	x	10
MN029	P-Handle	18	x	52	18	x	7-1/2

PNEUMATIC WHEEL ALUMINUM HAND TRUCKS

- Strong lightweight hand truck provides exceptional durability and versatility
- Weld-free construction for easy maintenance
- Wheel Size: 10" H x 3" W
- Capacity: 500 lbs.
- Shipped knocked down



Model No.	Handle Type	Overall Dimensions			Nose Plate Dimensions		
		W"	x	H"	W"	x	D"
MO079	P-Handle	18	x	52	18	x	7-1/2
MO076	Continuous	18	x	48	18	x	10
MO074	P-Handle	14	x	52	14	x	7-1/2
MO071	Dual Handle	18	x	52	18	x	7-1/2

Model No.	Handle Type	Overall Dimensions			Nose Plate Dimensions		
		W"	x	H"	W"	x	D"
MN026	Continuous	16	x	52	14	x	7-1/2
MN030	Dual Handle	16	x	52	18	x	7-1/2
MN031	Dual Handle	18	x	52	18	x	10
MN033	Continuous	21	x	52	18	x	7-1/2

HAND TRUCKS

ALUMINUM HAND TRUCKS

- Strength, durability and versatility in a lightweight truck
- Totally modular trucks have no welds to break
- 500-lb. capacity on all models
- Shipped knocked down



Model No.	Nose Plate W" x D"	Overall Ht."	Wheels	Wt. lbs.
A. MA250	14 x 7 1/2	48	8" Mold-On	18
B. MA269	18 x 7 1/2	48	8" Mold-On	19
C. MA275*	14 x 7 1/2	48	10" Pneumatic	21
D. MA258	14 x 7 1/2	52	8" Mold-On	19
D. MA255	14 x 7 1/2	52	10" Pneumatic	21
E. MA263	14 x 7 1/2	48	8" Mold-On	21
E. MA261	14 x 7 1/2	48	10" Pneumatic	24
F. MA271	18 x 9	48	8" Mold-On	19
F. MA270	18 x 9	48	10" Pneumatic	22
G. MA266	18 x 7 1/2	52	8" Mold-On	19
G. MA265	18 x 7 1/2	52	10" Pneumatic	22
H. MA268	18 x 7 1/2	54	8" Mold-On	19
H. MA267	18 x 7 1/2	52	10" Pneumatic	22

* Frame has a curved back for cylindrical or flat loads



FOLDING HAND TRUCK

- Easy-to-use latch system may be engaged with one hand
- Heavy-duty construction
- Features a comfort grip handle
- 8" mold-on rubber wheels
- 14" x 7" locking folding nose plate
- Overall height: 48"
- Capacity: 500 lbs.
- Weight: 22 lbs.

Model No. MN117



THREE-POSITION HAND TRUCK

- Can be used to transport all your needs, from general use items to bulky equipment
- 18" x 7 1/2" nose plate included
- Two 10" pneumatic wheels and two 5" polyurethane casters
- Two wheel position: 500 lbs. capacity, overall height 51"
- Four wheel position: 750 lbs. capacity, overall height 40"
- Weight: 43 lbs.

Model No. MN118



Y-CABLE BRAKE HAND TRUCK

- Provides safer load control and reduces operator's accumulated muscle strain
- Easy ergonomic self-equalizing brake actuators
- Stair climber included
- 18" x 9" nose plate
- 10" pneumatic wheels
- Overall height: 60"
- Capacity: 500 lbs.
- Weight: 38 lbs.

Model No. MN119



PORTABLE POLY HAND TRUCK DOCK PLATES

- Lightweight, ergonomic design is easy to use
- Beveled entry and exit edges
- For use with two and four-wheeled dollies, hand trucks and carts
- Raised surface for excellent traction in all weather conditions
- Aluminum legs for durability and strength
- Constructed of yellow HDPE

MO110



Model No.	Width Inside Curbs"	Overall Dimensions W" x L"	Capacity lbs.
MO110	32	35 x 36	750
MO111	45	48 x 36	750

HAND TRUCK CURB RAMPS

- Lightweight with two handles for easy pickup, carrying and handling
- Provides an ergonomically correct method to move heavy loads over curbs or up steps
- For use with hand trucks or wheeled carts
- Constructed of yellow HDPE



Model No.	Height" Min Max	Overall Dimensions W" x L"	Capacity lbs.
MO109	24 7	27 x 2-1/4	1000

ALUMINUM PLATFORM TRUCKS

- 40% lighter on average, than steel or wood-and-steel platform trucks
- Corrosion resistant for extra long life
- Box frame made of high strength all-welded aluminum channel
- Corner sockets at both ends allow handles to be used on either end of the truck
- Rubber corner bumpers prevent damage to walls and furniture
- Wide variety of casters to suit any application



8" PNEUMATIC CASTERS

Platform Dimensions"	Capacity lbs.	Smooth Deck Model No.	Wt. lbs.	Tread Plate Deck Model No.	Wt. lbs.
24 x 36	1400	ML901	51	ML904	52
24 x 48	1400	ML902	55	ML905	57
30 x 60	1400	ML903	66	ML906	68



ML901



ML910

10" PNEUMATIC CASTERS

Platform Dimensions"	Capacity lbs.	Smooth Deck Model No.	Wt. lbs.	Tread Plate Deck Model No.	Wt. lbs.
24 x 36	1850	ML907	56	ML910	57
24 x 48	1850	ML908	60	ML911	62
30 x 60	1850	ML909	71	ML912	73



ML916



ML922

8" FLAT-FREE CASTERS

Platform Dimensions"	Capacity lbs.	Smooth Deck Model No.	Wt. lbs.	Tread Plate Deck Model No.	Wt. lbs.
24 x 36	1100	ML913	54	ML916	55
24 x 48	1100	ML914	58	ML917	60
30 x 60	1100	ML915	69	ML918	71

10" FLAT-FREE CASTERS

Platform Dimensions"	Capacity lbs.	Smooth Deck Model No.	Wt. lbs.	Tread Plate Deck Model No.	Wt. lbs.
24 x 36	1200	ML919	58	ML922	59
24 x 48	1200	ML920	62	ML923	64
30 x 60	1200	ML921	73	ML924	75



ML925



ML931

8" MOLD-ON RUBBER CASTERS

Platform Dimensions"	Capacity lbs.	Smooth Deck Model No.	Wt. lbs.	Tread Plate Deck Model No.	Wt. lbs.
24 x 36	2000	ML925	64	ML928	65
24 x 48	2000	ML926	68	ML929	70
30 x 60	2000	ML927	79	ML930	71

6" POLYURETHANE CASTERS

Platform Dimensions"	Capacity lbs.	Smooth Deck Model No.	Wt. lbs.	Tread Plate Deck Model No.	Wt. lbs.
24 x 36	3400	ML931	48	ML934	49
24 x 48	3400	ML932	52	ML935	54
30 x 60	3400	ML933	63	ML936	65

8" POLYURETHANE CASTERS

Platform Dimensions"	Capacity lbs.	Smooth Deck Model No.	Wt. lbs.	Tread Plate Deck Model No.	Wt. lbs.
24 x 36	4000	ML937	53	ML940	54
24 x 48	4000	ML938	57	ML941	59
30 x 60	4000	ML939	68	ML942	70



ML940

PLATFORM TRUCKS

STEEL DECK PLATFORM TRUCKS

Choose from a large selection of deck sizes and casters to suit any institutional and/or industrial application.

- Made of strong 14-gauge steel deck with a 2" folded bottom lip for extra strength
- Removable 1 1/4" tubular chrome handle can be inserted at either end of platform
- Two rigid and two swivel casters (assembly required, hardware is included)

KLETON



CASTER WHEEL TYPES

Hi-Temp Nylon: Solid black nylon caster will not crush under heavy loads. Good for use on all types of surfaces from wood to concrete. Will tolerate temperatures from a low -28°C to a high of 230°C. Not affected by most corrosive chemicals.

Full Pneumatic: Air filled black rubber tire offers excellent shock absorbing properties. Smooth, quiet rolling over rough, uneven surfaces and outdoor terrain. Not recommended on floors with metal shavings or corrosive chemicals.

Mold-On Rubber: Molded rubber wheel bonded to a spoked cast iron core. The iron core gives it strength while the molded rubber provides easy, smooth and quiet rolling over rough terrain.

Non-Marking Rubber: Used for uneven surfaces and carpet areas. Its quiet rolling feature makes it ideal for both institutional and industrial applications. Will resist wet conditions and corrosive chemicals.

Polyolefin: Plastic wheel with high impact strength and non-chipping properties. Oil, grease and chemical resistant.



HEAVY-DUTY PLATFORM TRUCKS

WOOD DECK PLATFORM

- Sturdy 2" x 2" angle iron frame, with hardwood decking
- Ideal for carrying objects that scuff by metal to metal contact
- Steel frame absorbs shocks and handles uneven/heavy loads

ALL-STEEL PLATFORM

- Heavy 11-gauge, reinforced channel formed deck arc welded for maximum strength and long lasting rigidity
- Ideal for loads up to 2500 lbs.

CASTER PLACEMENT

- Available in standard-corner or diamond-tilt pattern
- Diamond tilt pattern allows the truck to tilt-balance slightly on the center side casters, allowing the truck to turn on its own length

KLETON



Wood Deck



All Steel



Standard Corner Placement



Diamond Tilt Placement

CASTER SELECTION:

To select the correct caster that is required for a specific application determine:

- 1) Platform size needed
- 2) Maximum load capacity it will carry
- 3) Type of floor surface it will roll on i.e., concrete, wood, tile etc...
- 4) Floor condition i.e., smooth, uneven, wet, chemicals, metal shavings, temperature etc.

Model No.	Wheel Dia."	Wheel Type	Load Capacity/lbs.	Wt. lbs.
24" W X 36" L PLATFORM TRUCKS				
MB232	6	Hi-Temp Nylon	1300	77
MB233	8	Hi-Temp Nylon	1400	87
MB234	8	Pneumatic	1000	79
MB235	6	Mold-On Rubber	900	88
MB236	8	Mold-On Rubber	1400	96
MB237	5	Non-Marking Rubber	1200	63
MB238	5	Polyolefin	900	61
24" W X 48" L PLATFORM TRUCKS				
MB240	6	Hi-Temp Nylon	1300	90
MB241	8	Hi-Temp Nylon	1400	100
MB242	8	Pneumatic	1000	92
MB243	6	Mold-On Rubber	900	101
MB244	8	Mold-On Rubber	1400	109
MB245	5	Non-Marking Rubber	1200	76
MB246	5	Polyolefin	900	74
30" W X 48" L PLATFORM TRUCKS				
MD421	6	Hi-Temp Nylon	1300	96
MD422	8	Hi-Temp Nylon	1400	106
MD423	8	Pneumatic	1000	98
MD424	6	Mold-On Rubber	900	107
MD425	8	Mold-On Rubber	1400	115
MD426	5	Non-Marking Rubber	1200	82
MD427	5	Polyolefin	900	80
30" W X 60" L PLATFORM TRUCKS				
MB248	6	Hi-Temp Nylon	1300	110
MB249	8	Hi-Temp Nylon	1400	120
MB250	8	Pneumatic	1000	112
MB251	6	Mold-On Rubber	900	121
MB252	8	Mold-On Rubber	1400	129
MB253	5	Non-Marking Rubber	1200	96
MB254	5	Polyolefin	900	94

10" Pneumatic Wheels 1200 lbs. Cap. Model No.	8" Rubber Wheels 2000 lbs. Cap. Model No.	8" Hi-Temp Nylon Wheels 2500 lbs. Cap. Model No.	Platform Dimensions* W" x L"	Wt. lbs.
WOOD DECK				
MB256	MB296	MB130	24 x 48-C	115
MB258	MB298	MB133	24 x 48-T	120
MB264	MB304	MB138	30 x 48-C	135
MB266	MB306	MB141	30 x 48-T	140
MB267	MB308	MB142	30 x 60-C	145
MB270	MD332	MB145	30 x 60-T	150
MB279	MB320	MB155	36 x 72-C	180
MB282	MB322	MB157	36 x 72-T	190
MB284	MB324	MB166	48 x 96-C	280
MB286	MB326	MB169	48 x 96-T	300
STEEL DECK				
MB255	MB295	MB131	24 x 48-C	110
MB257	MB297	MB132	24 x 48-T	115
MB263	MB303	MB139	30 x 48-C	130
MB265	MD331	MB140	30 x 48-T	135
MB268	MB307	MB143	30 x 60-C	140
MB269	MB309	MB144	30 x 60-T	145
MB280	MB319	MB154	36 x 72-C	175
MB281	MB321	MB156	36 x 72-T	185
MB283	MB323	MB167	48 x 96-C	240
MB285	MB325	MB168	48 x 96-T	265

* Suffix C after platform size signifies corner caster placement. T is diamond tilt.



CUSTOMISE IT TO YOUR SPECIFICATIONS.
SEE PAGE B87 FOR DETAILS

PLATFORM TRUCKS

HEAVY-DUTY PLATFORM TRUCKS

- Solid 7/8" hardwood deck with 5" x 1 5/8" hardwood sidewall
- Easy to manoeuvre with 44" high handle
- 15" deck height
- Two 12" hi-temp nylon load wheels and two 6" swivel casters
- Capacity: 3000 lbs.



Model No.	Platform Dimensions			Wt. lbs.
	W"	x	L"	
MB122	24	x	48	150
MB123	30	x	48	170
MB124	30	x	60	195
MB125	36	x	60	210
MB126	36	x	72	230

PLASTIC PLATFORM TRUCKS

- HDPE-molded structural plastic for strength and long-term durability
- Lightweight, easy to clean, chemical resistant and resists damage from long-term exposure to weather conditions
- Non-skid deck surface
- Removable steel handle
- Other caster options and capacities available upon request
- Caster assembly required



Model No.	Caster Type	Platform Size W" x L"	Deck Height"	Handle Height"	Capacity lbs.	Wt. lbs.
MN428	8" Mold-On Rubber	24 x 48	11	39	2000	90
MN429	8" Mold-On Rubber	30 x 60	11	39	2000	117
MN430	8" Polyurethane	24 x 48	11	39	2500	79
MN431	8" Polyurethane	30 x 60	11	39	2500	106
MN432	10" Pneumatic	24 x 48	13	41	1200	84
MN433	10" Pneumatic	30 x 60	13	41	1200	111
MN434	10" Flat-Free	24 x 48	13	41	1000	85
MN435	10" Flat-Free	30 x 60	13	41	1000	117
MN436	8" Pneumatic	24 x 48	11	39	1000	79
MN437	8" Pneumatic	30 x 60	11	39	1000	106
MN438	8" Flat-Free	24 x 48	11	39	900	80
MN439	8" Flat-Free	30 x 60	11	39	900	107

ELEVATED PLATFORM TRUCKS

- All-welded steel construction, ready-to-use
- 11-gauge steel deck with 2" square tube frames
- 1 1/4" round tube handle extends 14" above deck
- Removable handle
- Durable Kleton blue enamel finish



Model No.	Platform Dimensions		Deck Height	Wheel Type	Capacity lbs.
	W"	D"			
MN413	24	x 48	28	8" Hi-Temp Nylon	2000
MN414	30	x 60	28	8" Hi-Temp Nylon	2000
MN415	24	x 48	28	8" Mold-On Rubber	1800
MN416	30	x 60	28	8" Mold-On Rubber	1800
MN417	24	x 48	31	10" Pneumatic	1000
MN418	30	x 60	31	10" Pneumatic	1000

WAGON TRUCKS

- Fifth wheel steering makes these trucks easy to manoeuvre under full loads
- 14 1/4" deck height
- 10" pneumatic wheels
- Capacity: 1000 lbs.
- Durable Kleton blue enamel finish



Wood Deck Model No.	Wt. lbs.	Steel Deck Model No.	Wt. lbs.	Platform Dim.	
				W"	x L"
MD186	120	MD187	130	24	x 48
MD188	150	MD189	170	30	x 60
MD192	190	MD193	210	36	x 72

ERGONOMIC PLATFORM TRUCKS

- Ergonomic handle is placed at a comfortable working height to alleviate back strains
- Picking list holder eliminates the need to handle loose papers
- Deck is constructed from 14-gauge all welded steel with a turned down lip and reinforced channels
- Two rigid and two swivel 8" mold-on rubber casters
- 48" L x 24" W
- Capacity: 1200 lbs.
- Kleton powder coat finish

Model No. ML892



5TH WHEEL WAGON TRUCKS

- Ideal for moving heavy loads in manufacturing plants, warehouses, maintenance shops and outdoor environments
- Fifth wheel steering ensures tight turning radius and easy manoeuvrability
- Vinyl grip, powder coated "T" handle stays upright when not in use
- "T" handle is removable for towing capabilities (tow package sold separately)
- Steel reinforced deck for enhanced durability
- Molded-in tie-down slots for load security
- Textured deck channel and perimeter deck channel retains small items



Model No.	Overall Dimensions				Caster Type	Capacity lbs.	Wt. lbs.
	W"	x	L"	x H"			
ML585	24	x	42 7/8	x 16 3/4	10" Pneumatic	1200	60
ML586	24	x	42 7/8	x 16 3/4	10" Rubber	2000	60
ML587	24	x	54 7/8	x 17 1/2	12" Pneumatic	2000	71
ML588	24	x	54 7/8	x 17 1/2	12" Rubber	2000	71
ML589	30	x	66 7/8	x 17 1/2	12" Pneumatic	2000	88
ML590	30	x	66 7/8	x 17 1/2	12" Rubber	2000	88
ML591	40	x	70	x 48 5/8	12" Pneumatic	2000	125
ML592	40	x	70	x 50 3/4	16" Pneumatic	2000	130
ML593	Tow package				-	-	2.8

PLATFORM TRUCKS

INSTITUTIONAL PLATFORM TRUCKS

- Ideal truck for institutional applications - hospitals, restaurants, shopping centres, offices, industry and anywhere else a quiet ride and professional appearance is required
- 14-gauge steel deck with 2" lip underneath
- Non-skid rubber surface means product will not shift during use
- Rubber corner bumpers protect walls and furniture
- 1 1/4" tubular chrome handle with end panel contains small packages
- 5" non-marking rubber casters for a smooth, quiet ride; two rigid and two swivel
- Capacity: 1200 lbs
- Shipped knocked down



Model No.	Dimensions			Wt lbs.
	W"	x	L"	
MB190	24	x	36	64
MB208	24	x	48	70
MB207	30	x	48	88
MB209	30	x	60	100

FOLDING HANDLE PLATFORM TRUCKS

- Heavy gauge steel construction; non-skid vinyl coated deck
- Move supplies, forms and light equipment around the shop or office
- Quick-release handle folds flat for easy storage
- Vinyl, wrap around bumper protects walls and furniture
- 5" rubber casters



Model No.	Platform Dim.		Handle Height"	Cap. lbs.	Wt. lbs.
	W"	x L"			
MK988	19	x 29	33 1/2	400	28
MK989	23	x 35	34 1/2	660	42

FOLDABLE PLATFORM TRUCKS

- Ideal when solid, portable platform truck is required
- Interlocking aluminum frame has dual length platform: 16" W x 20" L or 16" W x 28" L; handle height is 32"
- Standard with vinyl corner bumpers
- Folds down to a compact 16" W x 20" L x 9 1/2" H
- Rolls easily on 5" rubber casters
- Capacity: 300 lbs.
- Weight: 18 lbs.

Model No. MK990



SEMI-LIVE SKIDS

- Ideal for temporary storage of materials
- Heavy 11-gauge steel deck with reinforced channels or 3/16" x 2" x 2" angle frame with hardwood deck
- 52" jack handle (sold separately) quickly engages skid and turns it into a portable truck that manoeuvres easily in confined areas
- Skids and handle come with 8" mold-on rubber wheels
- Capacity: 2000 lbs.
- Durable Kleton blue enamel finish



Steel Deck Model No.	Wt. lbs.	Wood Deck Model No.	Wt. lbs.	Deck Height	Platform Dimensions W" x L"
MB327	110	MB328	115	12	24 x 48
MB329	130	MB330	135	12	30 x 48
MB331	140	MB332	145	12	30 x 60
MB337	175	MB338	180	12	36 x 72
MB348		51" Long Jack Handle		30	

DEAD SKIDS

- Tough and durable platforms for temporary storage and handling of material
- Heavy 11-gauge steel deck with reinforced channels
- 3/16" x 2" x 2" angle frame with hardwood deck
- Available with steel or hardwood decks
- Four sturdy steel legs keep loads of the floor
- Can be stacked when not in use
- Capacity: 2500 lbs.
- Durable Kleton blue enamel finish



Model No.	Deck Dim. W" x L"	Platform Type	Deck Height"	Wt. lbs.
ML071	24 x 48	Steel	6	110
ML072	24 x 48	Wood	6	115
ML073	30 x 48	Steel	6	130
ML074	30 x 48	Wood	6	135
ML075	30 x 60	Steel	6	140
ML076	30 x 60	Wood	6	145
ML077	36 x 72	Steel	6	175
ML078	36 x 72	Wood	6	180

TROLLEY

- Durable construction resistant to chipping and peeling
- Three convenient handle positions: up, 45° angle and folded down
- 5" casters are resistant to marking
- Deck width 20-1/2"
- Deck length 31-3/4"
- Handle height: 27"
- Capacity: 500 lbs.
- Wheel diameter: 5"
- Wheel type: rubber
- Deck height: 6"

Model No. JH489



PLASTIC FLAT SHELF UTILITY SERVICE CART

- Durable structural foam construction will not dent, rust or bend
- Non-marking 4" casters
- Flat top shelf makes loading and unloading of heavy boxes easy
- Overall dimensions: 25 1/2" W x 40 1/2" L x 32 1/2" H
- Capacity: 500 lbs.

Model No. ML620



PLASTIC UTILITY SERVICE CARTS

- Durable structural foam construction will not dent, rust or bend
- Non-marking 4" casters
- Capacity: 500 lbs



ML619



ML618



Model No.	Overall Dimensions			
	W"	x	L"	x H"
ML618	17 1/2	x	34 1/2	x 32 1/2
ML619	25 1/2	x	40 1/2	x 32 1/2

LIGHT-DUTY UTILITY CARTS

- Durable plastic construction
- Comes with middle shelf and two convenient handles
- Shelves are flat with retaining beaded edges
- 4" swivel non-marking casters
- Platinum
- Assists in complying with HACCP guidelines



Model No.	Shelf Dimensions			Capacity lbs.	Wt. lbs.
	W"	L"	H"		
MH223	19	x 34	x 38	200	30
CART W/ENCLOSED END PANELS					
MH829	18	x 31	x 37 1/2	300	37



MH223

STAINLESS STEEL SHELF CARTS

- All-welded
- 430 stainless steel shelves and frame construction
- 4 swivel, zinc plated casters with non-marking rubber tread, polyurethane hub wheels
- Top and centre shelf include a 3 sided 1" lip
- Bottom shelf is flat with no lip
- Protection bumpers on legs and handles
- Shelves have reinforced hemmed front
- Overall capacity based upon evenly distributed weights
- NSF approved



MO250



Model No.	Caster Size"	Dimensions			Distance Between Shelves		Capacity lbs.
		W"	D"	H"	Top"	Bottom"	
MO250	3.5	15-1/2	x 24	x 32-1/8	12-3/4	12-3/4	300
MO251	3.5	17-5/8	x 33	x 27-1/8	13-1/4	13-1/4	300
MO252	4	15-3/4	x 32	x 24	12-1/2	14-5/8	500
MO253	4	18	x 27-3/8	x 32	13	14-1/2	500
MO254	5	21	x 37-1/4	x 35-1/8	14-3/8	14-1/2	500

TRADES CARTS

- Use as mobile workbench
- Sized to hold large tools and supplies yet fits in tight spaces
- Four compartmentalised parts box and two versatile storage bins
- Mounting bracket to serve as an electrical cord wrap and convenient handle bin to keep small tools/parts
- Constructed of black plastic for lightness and durability
- 5" casters (two with brakes)
- Also available with a fully enclosed, lockable storage compartment
- 19 1/4" W x 38" L x 33 3/8" H
- Capacity: 180 lbs. (top shelf), 150 lbs. (bottom shelf)
- Assembly required

Model No. MK744

Trades Cart Wt.: 50 lbs.

Model No. MK745

Trades Cart w/Lockable Cabinet Wt.: 68 lbs



MK744



MK745



FLAT SHELF UTILITY CARTS

- Ergonomic handle design improves control and worker safety
- Flat design makes loading and unloading of heavy boxes and parts easier
- Easy to reach tool/accessory hooks and storage area enhances productivity and organization
- Top shelf perimeter channel retains small items
- Constructed from sturdy structural foam that will not rust, dent, chip nor splinter
- Two rigid and two swivel 5" non-marking TPR casters
- Assembly required



ML456



Model No.	Beige	Dimensions			Capacity lbs.	Wt. lbs.
		W"	L"	H"		
ML456	ML457	17 1/4	x 38 1/2	x 38 1/4	500	33
ML458	ML459	25 7/8	x 43 7/8	x 33 1/4	500	42
ML460	ML461	25 1/4	x 54	x 38	750	52

HEAVY-DUTY UTILITY CARTS

- Ergonomic handle design improves control and worker safety
- Easy to reach tool/accessory hooks and storage area enhances productivity and organization
- 2 3/4" deep top shelf securely holds contents
- Constructed from sturdy structural foam that will not rust, dent, chip nor splinter
- Two rigid and two swivel casters
- Assembly required



ML448



Model No.	Beige	Caster Type	Dimensions			Capacity lbs.	Wt. lbs.
			W"	L"	H"		
ML448	ML449	5" Non-Marking TPR	17 7/8	x 39	x 38 1/4	500	31
ML450	ML451	5" Non-Marking TPR	25 7/8	x 45 1/4	x 38 1/4	500	44
ML452	-	8" Pneumatic	25 7/8	x 45 1/4	x 37 1/8	500	66
ML453	-	5" Non-Marking TPR	26	x 55	x 33 1/4	750	52
ML455	-	8" Pneumatic	26	x 55	x 33 1/4	750	74

UTILITY CARTS

KNOCKED-DOWN SHELF CARTS

- 16-gauge steel shelves with 2 1/2" high lip
- 1 1/2" x 1 1/2" x 12-gauge formed steel posts
- 1 1/4" diameter tubular steel handle
- Top and middle shelves can be installed lip up or down
- Two rigid and two swivel bolted-on casters
- Easy-to-assemble shipped knocked-down design
- Capacity: 900 lbs. evenly distributed
- Durable Kleton blue powder coat finish



KLETON



MB492

2-SHELF UTILITY CARTS

Model No.	Shelf Dim. W" x D"	Shelf Clearance"	Post Height"	Overall Height"	Wt. lbs.
5" BLUE ELASTIC RUBBER CASTERS					
MB492	18 x 30	25	30	36	43
MB493	24 x 36	25	30	36	54
MB494	24 x 48	25	30	36	69
5" POLYOLEFIN CASTERS					
MB482	18 x 30	25	30	36	42
MB483	24 x 36	25	30	36	53
MB484	24 x 48	25	30	36	68

3-SHELF UTILITY CARTS

Model No.	Shelf Dim. W" x D"	Shelf Clearance"	Post Height"	Overall Height"	Wt. lbs.
5" BLUE ELASTIC RUBBER CASTERS					
MB495	18 x 30	11	30	36	54
MB496	24 x 36	11	30	36	70
MB497	24 x 48	11	30	36	93
ML142	18 x 30	17	42	48	56
ML143	24 x 36	17	42	48	72
ML144	24 x 48	17	42	48	95
5" POLYOLEFIN CASTERS					
MB485	18 x 30	11	30	36	53
MB486	24 x 36	11	30	36	69
MB487	24 x 48	11	30	36	92
MN143	18 x 30	17	42	48	55
MN144	24 x 36	17	42	48	71
MN145	24 x 48	17	42	48	94

4-SHELF UTILITY CARTS

Model No.	Shelf Dim. W" x D"	Shelf Clearance"	Post Height"	Overall Height"	Wt. lbs.
5" BLUE ELASTIC RUBBER CASTERS					
ML145	18 x 30	10	42	48	66
ML146	24 x 36	10	42	48	85
ML147	24 x 48	10	42	48	115
ML148	18 x 30	15	55	61	68
ML149	24 x 36	15	55	61	87
ML150	24 x 48	15	55	61	117
5" POLYOLEFIN CASTERS					
MN148	18 x 30	10	42	48	65
MN149	24 x 36	10	42	48	84
MN150	24 x 48	10	42	48	114
MN151	18 x 30	15	55	61	67
MN152	24 x 36	15	55	61	86
MN153	24 x 48	15	55	61	116

5-SHELF UTILITY CARTS

Model No.	Shelf Dim. W" x D"	Shelf Clearance"	Post Height"	Overall Height"	Wt. lbs.
5" BLUE ELASTIC RUBBER CASTERS					
ML151	18 x 30	10	55	61	80
ML152	24 x 36	10	55	61	100
ML153	24 x 48	10	55	61	135
5" POLYOLEFIN CASTERS					
MN158	18 x 30	10	55	61	79
MN159	24 x 36	10	55	61	99
MN160	24 x 48	10	55	61	134

ERGONOMIC SHELF CARTS

- All-welded 16-gauge construction
- All-welded ergonomic handle placed at a comfortable working height
- Two rigid and two swivel 5" casters
- Capacity: 800 lbs. evenly distributed
- Durable Kleton blue enamel finish



ML563



KLETON

Model No.	Number of Shelves	Caster Type	Overall Dimensions W" x D" x H"
ML561	2	Blue Rubber	20 x 32 x 37
MN056	2	Blue Rubber	26 x 38 x 37
ML562	3	Blue Rubber	20 x 32 x 37
MN055	3	Blue Rubber	26 x 38 x 37
ML563	2	Polyolefin	20 x 32 x 37
ML883	2	Polyolefin	26 x 38 x 37
ML564	3	Polyolefin	20 x 32 x 37
ML884	3	Polyolefin	26 x 38 x 37

DEEP-LIPPED SERVICE CARTS

- All-welded design, ready-to-use
- Deep shelf lips for retention
- Two 14-gauge steel shelves welded to 1 1/2" x 1 1/2" x 1/8" steel posts
- 1" diameter tubular ergonomic handle
- Two rigid and two swivel 5" non-marking rubber casters
- Overall dimensions: 24" W x 42" D x 47" H
- Capacity: 1200 lbs. evenly distributed
- Durable Kleton blue enamel finish



Model No.	Shelf Size W" x D"	Shelf Lip Depth	Clearance Between Shelves	Wt. lbs.
MN393	24 x 36	Top 6"/Bottom 1 1/2"	22 1/2	85
MN394	24 x 36	Top 12"/Bottom 1 1/2"	16	90
MN395	24 x 36	Top 6"/Bottom 6"	18	90

UTILITY CART

- Shelf design allows for quick and easy loading
- Light and easy to maneuver
- Cart Material: Plastic
- Assembly required



JH486

KLETON

Model No.	No. of Shelves	Dimensions W" x D" x H"	Wheel Material	Capacity lbs.
JH486	3	19-3/4 x 40-1/4 x 37-1/2	Rubber	250
JH487	3	16-3/4 x 33-1/2 x 37	Rubber	250



CUSTOMISE IT TO YOUR SPECIFICATIONS.
SEE PAGE B87 FOR DETAILS

HEAVY-DUTY SHELF CARTS

- All-welded design ready to use
- Cart constructed from 14-gauge steel shelves welded to 1 1/2" x 1 1/2" x 1/8" steel angle posts
- Versatile for all material transport
- 1" diameter tubular steel handle
- Shelves are available with a 1 1/2" lip configured up or down
- Two rigid and two swivel 5" non-marking casters
- Capacity: 1200 lbs. evenly distributed
- Durable Kleton blue enamel finish



MB461



MB476

OVERALL HEIGHT: 36"

Lip Up Model No.	Lip Down Model No.	Shelf Dimensions W" x D"			No. Shelves	Clearance Between Shelves"	Handle Height"	Overall Dimensions W" x D" x H"			Wt. lbs.		
MB445	MB444	18	x	30	2	27	36	18	x	33	x	36	60
MB447	MB446	24	x	36	2	27	36	24	x	39	x	36	65
MB449	MB448	24	x	48	2	27	36	24	x	51	x	36	100
MB456	MB455	18	x	30	3	12	36	18	x	33	x	36	75
MB459	MB458	24	x	36	3	12	36	24	x	39	x	36	85
MB461	MB460	24	x	48	3	12	36	24	x	51	x	36	110

OVERALL HEIGHT: 48"

Lip Up Model No.	Lip Down Model No.	Shelf Dimensions W" x D"			No. Shelves	Clearance Between Shelves"	Handle Height"	Overall Dimensions W" x D" x H"			Wt. lbs.		
ML084	ML083	18	x	30	3	18	42	18	x	33	x	48	80
ML086	ML085	24	x	36	3	18	42	24	x	39	x	48	90
ML088	ML087	24	x	48	3	18	42	24	x	51	x	48	115
ML090	ML089	18	x	30	4	12	42	18	x	33	x	48	110
ML092	ML091	24	x	36	4	12	42	24	x	39	x	48	135
ML094	ML093	24	x	48	4	12	42	24	x	51	x	48	160

OVERALL HEIGHT: 61"

Lip Up Model No.	Lip Down Model No.	Shelf Dimensions W" x D"			No. Shelves	Clearance Between Shelves"	Handle Height"	Overall Dimensions W" x D" x H"			Wt. lbs.		
MB468	MB467	18	x	30	4	16	42	18	x	33	x	61	115
MB470	MB469	24	x	36	4	16	42	24	x	39	x	61	140
MB472	MB471	24	x	48	4	16	42	24	x	51	x	61	165
MB474	MB473	18	x	30	5	11	42	18	x	33	x	61	125
MB476	MB475	24	x	36	5	11	42	24	x	39	x	61	155
MB478	MB477	24	x	48	5	11	42	24	x	51	x	61	184



ML092

HEAVY-DUTY SHELF CARTS WITH DRAWER

- All-welded design ready to use
- Carts constructed from 14-gauge steel shelves welded to 1 1/2" x 1 1/2" x 1/8" steel angle posts
- 1" diameter tubular steel handle
- Drawer dimensions: 15 1/4" W x 20" D x 6" H, 100-lb. capacity
- Available with two or three shelves with 1 1/2" lip configured up
- Two rigid and two swivel bolted-on 5" non-marking casters
- Capacity: 1200 lbs. evenly distributed
- Durable Kleton blue enamel finish



Model No.	Shelf Dimensions W" x D"			Number of Shelves	Clearance Between Shelves"	Drawer to Shelf Clearance"	Handle Height"	Overall Dimensions W" x D" x H"			Wt. lbs.		
MH255	24	x	36	2	27	18	36	24	x	39	x	36	75
MH256	24	x	36	3	12	3	36	24	x	39	x	36	95



MH255

ORDER PICKING CARTS

- All-welded design for durability and long life
- Picking list holder eliminates the need to handle loose papers
- 14-gauge steel shelves with 1 1/2" lip, configured up
- Two rigid and two swivel bolted 5" non-marking rubber casters
- Capacity: 1200 lbs. evenly distributed
- Durable Kleton blue enamel finish



Model No.	Shelf Dimensions W" x D"			No. Shelves	Between Shelves"	Handle Height"	W"	Overall Dimensions x D" x H"			Wt. lbs.	
MB440	18	x	30	2	27	36	18	x	46	x	36	70
MB441	24	x	36	2	27	36	24	x	52	x	36	80
ML095	24	x	48	2	27	36	24	x	64	x	36	110
MB442	18	x	30	3	12	36	18	x	46	x	36	85
MB443	24	x	36	3	12	36	24	x	52	x	36	100
ML096	24	x	48	3	12	36	24	x	64	x	36	120



MB442



CUSTOMISE IT TO YOUR SPECIFICATIONS.
SEE PAGE B87 FOR DETAILS

UTILITY CARTS

HEAVY-DUTY LOW PROFILE SHOP CARTS

- All-welded cart with low shelf means less distance to lift heavy objects
- Two 14-gauge steel shelves with a 1 1/2" lip down
- 1 1/4" diameter tubular steel handle
- Two rigid and two swivel bolted-on casters
- Durable Kleton blue enamel finish



KLETON



5" RUBBER CASTERS

- Non-marking casters are quiet rolling and ideal for both institutional and industrial applications
- Casters are resistant to wet and corrosive chemical conditions
- Capacity: 1200 lbs. evenly distributed

Model No.	Shelf Dimensions			Clearance Between Shelves"	Top Shelf Height"	O.A. Dim.			Wt. lbs.
	W"	x	L"			W"	x	H"	
MB421	18	x	30	16	26	18	x	34 x 40	90
MB425	24	x	36	16	26	24	x	40 x 40	110
MB429	24	x	48	16	26	24	x	52 x 40	125
ML097	24	x	60	16	26	24	x	64 x 40	155
ML098	30	x	48	16	26	30	x	52 x 40	155
MB434	30	x	60	16	26	30	x	64 x 40	165
ML099	30	x	72	16	26	30	x	76 x 40	175

6" HI-TEMP NYLON OR POLYURETHANE CASTERS

- Solid black hi-temp nylon casters handle heavy loads easily
- Solid polyurethane casters are non-marking and are highly resistant to wear
- Best choice in uneven floor applications
- Capacity: 2400 lbs. evenly distributed

6" Nylon Model No.	6" Polyurethane Model No.	Shelf Dim. W" x L"	Clearance Between Shelves"	Top Shelf Height"	O.A. Dim. W" x L" x H"	Wt. lbs.
MB422	ML103	18 x 30	16	27	18 x 34 x 41	100
MB426	ML104	24 x 36	16	27	24 x 40 x 41	130
MB430	ML105	24 x 48	16	27	24 x 52 x 41	145
ML100	ML106	24 x 60	16	27	24 x 64 x 41	155
ML101	ML107	30 x 48	16	27	30 x 52 x 41	155
MB435	ML108	30 x 60	16	27	30 x 64 x 41	165
ML102	ML109	30 x 72	16	27	30 x 76 x 41	175

STOCK PICKING CARTS

- All-welded design for durability and long life
- Pick and transport stock without the need for a separate ladder
- Slip-resistant steps and positive locking engagement for safety
- Step rise: 9 1/2"
- Three 14-gauge steel shelves with 1 1/2" lip, configured up
- Clearance between shelves: 12"
- Two rigid and two swivel bolted-on 5" non-marking rubber casters
- Capacity: 1200 lbs. evenly distributed
- Durable Kleton blue enamel finish

MB507



KLETON

Model No.	Shelf Dim. W" x D"	Number of Steps	Step Dim. W" x D"	Overall Dimensions W" x D" x H"			Wt. lbs.
MD441	24 x 36	3	22 x 4	24	x	52 x 61	135
MB507	24 x 48	3	22 x 4	24	x	64 x 61	140
MD442	24 x 36	5	22 x 4	24	x	52 x 78	145
MB508	24 x 48	5	22 x 4	24	x	64 x 78	150



CUSTOMISE IT TO YOUR SPECIFICATIONS. SEE PAGE B87 FOR DETAILS

SHELF/PLATFORM TRUCKS

- 2-in-1 shelf truck features removable top shelf and post assembly - converts into a platform truck when removed
- Standard features include: two front corner non-marking bumpers, four 5" non-marking rubber casters (two rigid and two swivel), two crossbars on push handle, all-welded heavy gauge steel assembly
- Shelf dimensions: 24" W x 36" L
- Top shelf capacity: 500 lbs. evenly distributed
- Bottom shelf capacity: 800 lbs. evenly distributed
- Durable Kleton blue enamel finish



KLETON

Model No.	Overall Dimensions W" x L" x H"			Top Shelf H"	Wt. lbs.
MB391	26	x	38 x 40	32	105

A-FRAME SHEET/PANEL TRUCKS

- Ideal for handling long, flat, awkward loads
- Frame is constructed of all-welded 2" angle
- Available with open or closed base
- Four bolted-on 5" non-marking rubber swivel casters
- Durable Kleton blue enamel finish
- 1200-lb. capacity evenly distributed



ML064



MD217



KLETON

Model No.	Overall Dimensions W" x L" x H"			Base Type	Wt. lbs.
MD216	24	x	36 x 55	Open	50
ML063	24	x	36 x 55	Closed	60
MD217	30	x	42 x 55	Open	60
ML064	30	x	42 x 55	Closed	75
MD218	36	x	72 x 55	Open	85
ML065	36	x	72 x 55	Closed	110

MOBILE PIPE & BAR RACKS

- All-welded steel construction, ready to use
- 3 double sided storage levels with 7" high uprights to secure load
- Useable space per side 6"-11"-15" (top-middle-bottom)
- Capacity: 3000 lbs.
- Cart Material: Steel
- Wheel Material: Polyurethane
- Capacity is based on evenly distributed weight
- Durable Kleton blue enamel finish

MO249



KLETON

Model No.	Dimensions W" x D" x H"		
MO248	48	x	36 x 60
MO249	72	x	36 x 60

FLAT BED LUMBER CARTS

- All-welded cart is ideal for transporting large panel or sheets in a horizontal position
- Four 6" swivel and two 6" rigid bolted-on non-marking polyurethane casters
- Durable Kleton blue enamel finish

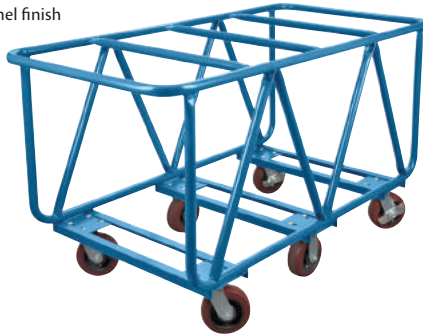

KLETON

Model No.	Overall Dimensions W" x L" x H"	Wt. lbs.	Cap lbs.
ML141	30 x 60 x 33	160	2500

DRYWALL CARTS

- All-welded multi-purpose cart is ideal for transporting drywall, wood or metal sheets
- 1 1/4" tubular rail handle and thick 11-gauge steel platform
- Two rigid and two swivel 8" bolted-on casters
- Deck dimensions: 15" W x 44" L x 14" H
- Overall dimensions: 24" W x 44" L x 44" H
- Durable Kleton blue enamel finish



Model No.	Caster Type	Deck Angle°	Cap. lbs.	Wt. lbs.
ML139	8" Mold-On Rubber	80	2000	115
MD214	8" Polyurethane	80	3500	110

LUMBER CARTS

- All-welded cart is ideal for transporting long and bulky items
- Welded 14-gauge 12" x 38" steel shelf
- Grey rubber bumpers protect walls and equipment
- Two rigid and two swivel bolted-on casters
- Capacity: 1200 lbs.
- Durable Kleton blue enamel finish



Model No.	Deck Dim. W" x L" x H"	Shelf Height"	Overall Dim. W" x L" x H"	Caster Type	Wt. lbs.
MB729	24 x 36 x 8	34	26 x 39 x 42	5" Rubber	80
ML140	24 x 36 x 10	36	26 x 39 x 45	6" Rubber	100

KNOCKED-DOWN PANEL TRUCK

- Move tables, drywall, plywood, tables, artwork at ease
- Move light to heavy duty objects at ease with (4) 5" non-marking blue elastic swivel casters
- Removable upright panel bars fit any size load
- Ships knocked-down for freight savings and damage avoidance
- Capacity is based on evenly distributed weight
- Overall Height: 43"
- Overall Length: 30"
- Overall Width: 27"
- Capacity: 1000 lbs.
- Wheel Diameter: 5"
- Wheel Material: Rubber

Model No. MO522 - Open-Deck
Model No. MO523 - Carpet-Deck



HEAVY-DUTY PANEL & LUMBER MOVER TRUCKS

- All-welded, ready to use
- Constructed from 1 1/4" round tubing and an 11-gauge deck
- Ideal for transporting large sheets and long parts
- Uprights extend 21" and 33" above deck
- Deck is 12" off the floor
- 8" clear space between tubes
- Two rigid and two swivel 8" casters
- Durable Kleton blue enamel finish



Model No.	Overall Dimensions W" x L" x H"	Caster Type	Cap. lbs.	Wt. lbs.
ML360	30 x 48 x 45	Mold-On Rubber	2000	160
ML361	30 x 48 x 45	Polyurethane	2500	175
ML362	30 x 60 x 45	Mold-On Rubber	2000	160
ML363	30 x 60 x 45	Polyurethane	2500	175

SINGLE LEVEL RAILS HEAVY-DUTY PANEL MOVER TRUCKS

- All-welded truck ideal for transporting large sheets and long parts
- Construction from 1 1/4" round tubing and reinforced 11-gauge deck
- Uprights extend 33" above deck
- Deck is 12" off the floor
- Overall height is 45"
- 8" clear space between tubes
- Two rigid and two swivel 8" casters
- Durable Kleton blue enamel finish



Model No.	Overall Dimensions W" x L" x H"	Caster Type	Capacity lbs.	Wt. lbs.
ML549	30 x 48 x 45	8" Mold-On Rubber	2000	139
ML550	30 x 48 x 45	8" Polyurethane	2500	139
ML551	30 x 60 x 45	8" Mold-On Rubber	2000	161
ML552	30 x 60 x 45	8" Polyurethane	2500	161



CUSTOMISE IT TO YOUR SPECIFICATIONS.
SEE PAGE B87 FOR DETAILS

WIRE MESH STOCK CARTS

WIRE MESH UTILITY CARTS

- Rugged all-welded steel construction ready to use
- Designed for efficient loading/unloading and transportation of merchandise
- 14-gauge steel shelves, 1 1/2" lip up
- Frame constructed from 1 1/2" angle iron and 2" x 2" wire mesh

- **Includes:** Two rigid and two swivel 5" or 6" bolted-on casters
- Capacity: 1200-2400 lbs. evenly distributed
- Durable Kleton blue enamel finish

5" Non-Marking Rubber 1200-lb. Cap. Model No.	6" Polyurethane 2400-lb. Cap. Model No.	Base W" x L"	Inside Wall Height"	Handle Height"	Clearance Between Shelves"	Overall Dimensions W" x L" x H"	Wt. lbs.
TWO-SIDED, TWO SHELVES							
ML162	ML168	24 x 36	55	42	26	24 x 39 x 63	95
ML163	ML169	24 x 48	55	42	26	24 x 51 x 63	112
ML164	ML170	24 x 60	55	42	26	24 x 63 x 63	127
ML165	ML171	30 x 48	55	42	26	30 x 51 x 63	129
ML166	ML172	30 x 60	55	42	26	30 x 63 x 63	144
ML167	ML173	30 x 72	55	42	26	30 x 75 x 63	167
TWO-SIDED, THREE SHELVES							
ML174	ML180	24 x 36	55	42	16 1/2	24 x 39 x 63	120
ML175	ML181	24 x 48	55	42	16 1/2	24 x 51 x 63	137
ML176	ML182	24 x 60	55	42	16 1/2	24 x 63 x 63	152
ML177	ML183	30 x 48	55	42	16 1/2	30 x 51 x 63	154
ML178	ML184	30 x 60	55	42	16 1/2	30 x 63 x 63	169
ML179	ML185	30 x 72	55	42	16 1/2	30 x 75 x 63	192
THREE-SIDED, ONE SHELF							
ML220*	ML190*	24 x 36	55	42	-	24 x 39 x 63	102
ML221*	ML191*	24 x 48	55	42	-	24 x 51 x 63	110
ML222*	ML192*	24 x 60	55	42	-	24 x 63 x 63	120
ML223*	ML193*	30 x 48	55	42	-	30 x 51 x 63	135
ML224*	ML194*	30 x 60	55	42	-	30 x 63 x 63	145
ML225*	ML195*	30 x 72	55	42	-	30 x 75 x 63	155
THREE-SIDED, TWO SHELVES							
ML196	ML202	24 x 36	55	42	26	24 x 39 x 63	127
ML197	ML203	24 x 48	55	42	26	24 x 51 x 63	142
ML198	ML204	24 x 60	55	42	26	24 x 63 x 63	159
ML199	ML205	30 x 48	55	42	26	30 x 51 x 63	182
ML200	ML206	30 x 60	55	42	26	30 x 63 x 63	192
ML201	ML207	30 x 72	55	42	26	30 x 75 x 63	211
THREE-SIDED, THREE SHELVES							
ML208	ML214	24 x 36	55	42	16 1/2	24 x 39 x 63	152
ML209	ML215	24 x 48	55	42	16 1/2	24 x 51 x 63	174
ML210	ML216	24 x 60	55	42	16 1/2	24 x 63 x 63	198
ML211	ML217	30 x 48	55	42	16 1/2	30 x 51 x 63	229
ML212	ML218	30 x 60	55	42	16 1/2	30 x 63 x 63	239
ML213	ML219	30 x 72	55	42	16 1/2	30 x 75 x 63	267

* Base shelf only

SECURITY TRUCKS

- Rugged all-welded steel construction, ready to use
- Designed for efficient loading/unloading and transportation of merchandise
- 14-gauge steel shelves, 1 1/2" lip up
- Frame constructed from 1 1/2" angle iron and 2" x 2" wire mesh

- **Includes:** Two rigid and two swivel 5" or 6" bolted-on casters
- Comes with hasp for padlock
- Capacity: 1200-2400 lbs. evenly distributed
- Durable Kleton blue enamel finish

5" Non-Marking Rubber 1200-lb. Cap. Model No.	6" Polyurethane 2400-lb. Cap. Model No.	Base W" x L"	Inside Wall Height"	Handle Height"	Clearance Between Shelves"	Overall Dimensions W" x L" x H"	Wt. lbs.
TWO SHELVES							
ML238	ML244	24 x 36	55	42	25	26 x 39 x 62 1/2	157
ML239	ML245	24 x 48	55	42	25	26 x 51 x 62 1/2	172
ML241	ML247	30 x 48	55	42	25	32 x 51 x 62 1/2	212
ML242	ML248	30 x 60	55	42	25	32 x 63 x 62 1/2	222
ML243	ML249	30 x 72	55	42	25	32 x 75 x 62 1/2	241
THREE SHELVES							
ML250	ML256	24 x 36	55	42	16	26 x 39 x 62 1/2	182
ML251	ML257	24 x 48	55	42	16	26 x 51 x 62 1/2	204
ML253	ML259	30 x 48	55	42	16	32 x 51 x 62 1/2	259
ML254	ML260	30 x 60	55	42	16	32 x 63 x 62 1/2	269
ML255	ML261	30 x 72	55	42	16	32 x 75 x 62 1/2	297

BOX TRUCKS

- Rugged all-welded steel construction, ready to use
- Contain and transport small bulk parts or materials in your plant or warehouse
- Frame constructed from 1 1/2" angle iron construction and 2" x 2" wire mesh

- **Includes:** Two rigid and two swivel 5" non-marking bolted-on rubber casters
- Capacity: 1200 lbs. evenly distributed
- Durable Kleton blue enamel finish

Model No.	Base W" x L"	Inside Wall Height"	Handle Height"	Overall Dim. W" x L" x H"	Wt. lbs.
MB672	24 x 36	24	30	24 x 39 x 31 1/2	62
ML186	24 x 48	24	30	24 x 51 x 31 1/2	75
ML187	24 x 60	24	30	24 x 63 x 31 1/2	85

Model No.	Base W" x L"	Inside Wall Height"	Handle Height"	Overall Dim. W" x L" x H"	Wt. lbs.
ML188	30 x 48	24	30	30 x 51 x 31 1/2	86
ML680	30 x 60	24	30	30 x 63 x 31 1/2	95
ML189	30 x 72	24	30	30 x 75 x 31 1/2	107



ML163



ML200



ML254



CUSTOMISE IT TO YOUR SPECIFICATIONS. SEE PAGE B87 FOR DETAILS



HARDWOOD DOLLIES

- Kiln dried
- Countersunk bolts prevent scratches
- Wood thickness: 7/8"
- Rounded edges and handles facilitate storage and movability
- Non-marking casters
- Shipped knocked down



MN204



MN217



MN200



REPLACEMENT CASTERS

Model No.	Description
ML391	3" Swivel Polyolefin
ML044	3" Swivel Polyurethane
ML393	4" Swivel Polyolefin
ML333	4" Swivel Blue Elastic Rubber
ML045	4" Swivel Polyurethane

CHOOSE FROM THREE CASTER TYPES



4" Polyolefin

3" Polyurethane

4" Blue Elastic Rubber

Model No.	Dimensions W" x D"	Caster Type	Caster"	Capacity lbs.*
ALL WOOD				
MN189	18 x 24	Polyolefin	3	900
MN195	18 x 24	Polyurethane	3	900
MN201	18 x 24	Polyolefin	4	1000
MN213	18 x 24	Blue Elastic	4	1400
MN207	18 x 24	Polyurethane	4	1600
MN192	18 x 30	Polyolefin	3	900
MN198	18 x 30	Polyurethane	3	900
MN204	18 x 30	Polyolefin	4	1000
MN216	18 x 30	Blue Elastic	4	1400
MN210	18 x 30	Polyurethane	4	1600

Model No.	Dimensions W" x D"	Caster Type	Caster"	Capacity lbs.*
CARPETED ENDS				
MN190	18 x 24	Polyolefin	3	900
MN196	18 x 24	Polyurethane	3	900
MN202	18 x 24	Polyolefin	4	1000
MN214	18 x 24	Blue Elastic	4	1400
MN208	18 x 24	Polyurethane	4	1600
MN193	18 x 30	Polyolefin	3	900
MN199	18 x 30	Polyurethane	3	900
MN205	18 x 30	Polyolefin	4	1000
MN217	18 x 30	Blue Elastic	4	1400
MN211	18 x 30	Polyurethane	4	1600

Model No.	Dimensions W" x D"	Caster Type	Caster"	Capacity lbs.*
RUBBER ENDS				
MN191	18 x 24	Polyolefin	3	900
MN197	18 x 24	Polyurethane	3	900
MN203	18 x 24	Polyolefin	4	1000
MN215	18 x 24	Blue Elastic	4	1400
MN209	18 x 24	Polyurethane	4	1600
MN194	18 x 30	Polyolefin	3	900
MN200	18 x 30	Polyurethane	3	900
MN206	18 x 30	Polyolefin	4	1000
MN218	18 x 30	Blue Elastic	4	1400
MN212	18 x 30	Polyurethane	4	1600

* Evenly distributed

WOOD DOLLY RACKS

- Convert a basic wood dolly into a multi-purpose panel caddy
- All-welded 1" tube design for durability
- Tubular steel rack is padded to prevent scratching or marring
- Durable Kleton blue enamel finish



Wood dolly not included



Model No.	Description	Wt. lbs.
MD549	Use with Wood Dolly 18" x 24"	12
MD550	Use with Wood Dolly 18" x 30"	15

STEEL DECK DOLLIES

- Heavy-duty, all-welded 14-gauge steel deck
- Four bolted-on 4" swivel non-marking rubber casters
- MA199 - Optional 34" long steel T-handle for ease of movement under full loads
- Capacity: 1200 lbs. evenly distributed
- Caster assembly required
- Durable Kleton blue enamel finish

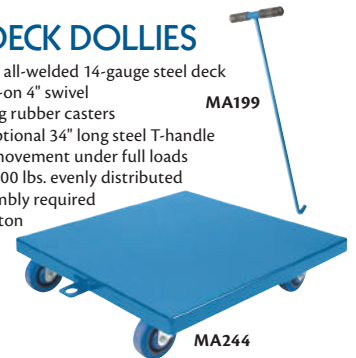

Model No.	Dimensions W" x D" x H"	Wt. lbs.
MA242	18 x 18 x 7	23
MA243	18 x 24 x 7	25
MA244	24 x 24 x 7	27
MA199	34" Handle	2

ANGLE FRAME DOLLIES

- Heavy-duty all-welded 1 1/2" x 1 1/2" x 1/8" angle frame construction
- Four bolted-on 4" swivel non-marking rubber casters
- Capacity: 1200 lbs. evenly distributed
- Caster assembly required
- Durable Kleton blue enamel finish



MA193



Model No.	Dimensions W" x D" x H"	Wt. lbs.
MA190	18 x 18 x 7	23
MA191	18 x 24 x 7	25

Model No.	Dimensions W" x D" x H"	Wt. lbs.
MA192	24 x 24 x 7	27
MA193	24 x 36 x 7	30

PREMIUM HARDWOOD DOLLIES

MEDIUM-DUTY

- 7/8" wood top; countersunk bolts
- Carpeted dolly will prevent marks and scratches on equipment being moved
- 3" polyolefin casters
- Capacity: 900-lbs. evenly distributed
- Shipped knocked down

HEAVY-DUTY

- 1 3/4" wood top (2 x 1 1/16" pieces); countersunk bolts
- Carpeted dolly will prevent marks/scratches on equipment
- 4" resilient non-marking casters
- Capacity: 1400 lbs. evenly distributed
- Shipped knocked down



Medium-duty



Heavy-duty



Model No.	Dim. W" x D"	Platform Type	Wt. lbs.
MEDIUM-DUTY			
MA186	18 x 24	Standard	16
MA187	18 x 24	Carpeted	18
MD515	18 x 30	Standard	18
MD516	18 x 30	Carpeted	20

Model No.	Dim. W" x D"	Platform Type	Wt. lbs.
HEAVY-DUTY			
MA188	18 x 24	Standard	20
MA189	18 x 24	Carpeted	22
MD517	18 x 30	Standard	22
MD518	18 x 30	Carpeted	24

POLYETHYLENE DOLLIES

- Frame Material: Polyethylene
- Capacity: 1000 lbs. evenly distributed
- Deck Dimensions: 18" W x 30" L
- Deck Height: 6"
- Wheel Material: Rubber
- Steel reinforced structure
- Includes four 4" casters
- Will not splinter or swell
- Round corners and edges
- Rolls easily



MN674



MN675

Model No.	Description	Wt. lbs.
MN674	Flush Top Design	22
MN675	Padded Top Design	25



BOX TRUCKS

MINI STARCARTS™

- Designed to take the punishment of industrial and institutional applications at an economical price
- Polyethylene construction
- Plated steel undercarriage
- 3" all swivel Threadguard casters, corner placement
- Colour: Grey



NC460

Model No.	Capacity		O.A. Dimensions				Wt. lbs.
	Cu. ft.	lbs.	L" x W" x H"	L" x W" x H"	L" x W" x H"		
NC460	5	200	21 x 21 x 27	21 x 21 x 27	21 x 21 x 27	20	
NC461	6	200	33 x 19 x 28	33 x 19 x 28	33 x 19 x 28	25	
NC462	7	200	33 x 23 x 24	33 x 23 x 24	33 x 23 x 24	25	
NC463	7	200	24 x 24 x 38	24 x 24 x 38	24 x 24 x 38	30	
NA001	8	300	35 x 25 x 25	35 x 25 x 25	35 x 25 x 25	30	
NC464	9	300	48 x 19 x 28	48 x 19 x 28	48 x 19 x 28	40	

EASY-ACCESS STARCARTS™

- Drop-style sidewall allows cart to be loaded and unloaded easily
- Treated plywood undercarriage
- 5" Threadguard casters available in corner or diamond pattern
- Colour: Grey



NA009



Model No.	Capacity		O.A. Dimensions				Caster Placement	Wt. lbs.
	Cu. ft.	lbs.	L" x W" x H"	L" x W" x H"	L" x W" x H"			
MN645	19	800	43 x 31 x 36	43 x 31 x 36	43 x 31 x 36	Corner	52	
MN646	19	800	43 x 31 x 36	43 x 31 x 36	43 x 31 x 36	Diamond	52	
NA009	21	900	46 x 31 x 39	46 x 31 x 39	46 x 31 x 39	Corner	75	
NA010	21	900	46 x 31 x 39	46 x 31 x 39	46 x 31 x 39	Diamond	75	
MN132	24	900	46 x 31 x 49	46 x 31 x 49	46 x 31 x 49	Corner	85	
MN133	24	900	46 x 31 x 49	46 x 31 x 49	46 x 31 x 49	Diamond	85	
NA011	24	900	63 x 31 x 39	63 x 31 x 39	63 x 31 x 39	Corner	10	
NA012	24	900	63 x 31 x 39	63 x 31 x 39	63 x 31 x 39	Diamond	100	

HEAVY-DUTY OVERSIZED STARCARTS™

- Tapered walls for easy shipping and storage
- Treated plywood undercarriage
- Corner or diamond caster placement
- Colour: Grey (other colours available)



ML543



Model No.	Capacity		Dimensions				Caster Dia."	Caster Placement	Wt lbs.
	Cu.ft.	lbs.	L" x W" x H"	L" x W" x H"	L" x W" x H"				
ML543	22	800	59 x 35 x 32	59 x 35 x 32	59 x 35 x 32	5	Corner	70	
ML544	22	800	59 x 35 x 32	59 x 35 x 32	59 x 35 x 32	5	Diamond	70	
ML545	24	800	53 x 35 x 38	53 x 35 x 38	53 x 35 x 38	5	Corner	85	
ML546	24	800	53 x 35 x 38	53 x 35 x 38	53 x 35 x 38	5	Diamond	85	
ML547	46	1,600	78 x 42 x 42	78 x 42 x 42	78 x 42 x 42	6	Corner	115	
ML548	46	1,600	78 x 42 x 42	78 x 42 x 42	78 x 42 x 42	6	Diamond	115	

STARCARTS™

- Polyethylene construction
- Choice of 3" or 4" Threadguard casters depending on model
- Corner or diamond caster placement
- Treated plywood undercarriage
- Body colour: Grey
- Other colours available



NA004

MN466



Model No.	Capacity		O.A. Dimensions				Caster Dia."	Caster Placement	Wt. lbs.
	Cu. ft.	lbs.	L" x W" x H"	L" x W" x H"	L" x W" x H"				
NA002	12	400	39 x 27 x 30	39 x 27 x 30	39 x 27 x 30	3	Diamond	40	
NA004	12	800	39 x 27 x 31	39 x 27 x 31	39 x 27 x 31	4	Corner	50	
NA003	12	800	39 x 27 x 31	39 x 27 x 31	39 x 27 x 31	4	Diamond	50	
NC465	15	400	41 x 29 x 31	41 x 29 x 31	41 x 29 x 31	3	Diamond	45	
NC466	15	800	41 x 29 x 32	41 x 29 x 32	41 x 29 x 32	4	Corner	55	
NC467	15	800	41 x 29 x 32	41 x 29 x 32	41 x 29 x 32	4	Diamond	55	
NA006	16	400	43 x 31 x 33	43 x 31 x 33	43 x 31 x 33	3	Diamond	50	
NA007	16	800	43 x 31 x 34	43 x 31 x 34	43 x 31 x 34	4	Corner	60	
NA008	16	800	43 x 31 x 34	43 x 31 x 34	43 x 31 x 34	4	Diamond	60	
NC468	19	800	43 x 31 x 36	43 x 31 x 36	43 x 31 x 36	4	Corner	65	
NC469	19	800	43 x 31 x 36	43 x 31 x 36	43 x 31 x 36	4	Diamond	65	

OPTIONAL SPRING PLATFORM

- Optional spring platform eliminates excess bending, therefore reducing the risk of back related injuries

Model No.	Description
MN466	Can be used with NA002, NA003 & NA004
MN467	Can be used with NC465, NC466, NC467, NA006, NA007, NA008, NC468 & NC469

HEAVY-DUTY STARCARTS™

- Designed to offer increased load capacity while maintaining easy mobility
- Molded 100% polyethylene body has a double wall box style lip for greater resistance to impact
- Steel undercarriage
- Molded handle
- 10" and 12" semi-pneumatic wheels are made of durable hard rubber
- 5" swivel rubber or 6" swivel phenolic casters depending on capacity
- Colour: Blue



NG033



Model No.	Capacity		O.A. Dimensions				Wheel Dia."	Caster Dia."	Wt. lbs.
	Cu. ft.	lbs.	L" x W" x H"	L" x W" x H"	L" x W" x H"				
NG033	16	1000	48 x 31 x 34 1/2	48 x 31 x 34 1/2	48 x 31 x 34 1/2	10	5	80	
NA052	24	1000	60 x 31 1/2 x 35 1/2	60 x 31 1/2 x 35 1/2	60 x 31 1/2 x 35 1/2	12	5	100	
NA053	39	1500	72 x 35 1/2 x 40	72 x 35 1/2 x 40	72 x 35 1/2 x 40	12	6	130	

JUMBO STARCARTS™

- 6" Threadguard casters in diamond pattern (corner pattern available on request)
- Recessed plywood undercarriage
- Easy access cut-out
- Colour: Grey



Model No.	Capacity		Inside Dim.			Outside Dim.			Max. Load lbs.	Wt. lbs.
	Cu. ft.	lbs.	L" x W" x H"	L" x W" x H"	L" x W" x H"					
NG956	38	60	60 x 40 x 28	62 x 44 x 38	62 x 44 x 38	1200	180			
NG957	60	62	62 x 42 x 42	65 x 45 x 54	65 x 45 x 54	1500	200			

Note: Available with various cut-out options

HEAVY-DUTY WHITE WALL POLY BOX TRUCK

- Seamless durable 100% polyethylene bins
- Leakproof and easy to clean
- Available with 3/4" treated plywood undercarriage or all-welded steel chassis with a durable Kleton blue enamel finish
- Includes 2 swivel and 2 rigid casters
- Capacity is based on evenly distributed weight
- Caster type: 4" non-marking blue rubber
- Bin colour: White
- Bin material: White polyethylene
- Caster placement: Corner standard



KLETON

Model No.	Base	Capacity Cu. ft.	lbs.	Overall Dimensions L" x W" x H"
TAPERED WALL				
MN990*	Plywood	7	600	33 x 20 x 29
MN991*	Steel Chassis	7	1000	33 x 20 x 29
MN992*	Plywood	9	600	37 x 26 x 31
MN993*	Steel Chassis	9	1000	37 x 26 x 31
MN994*	Plywood	12	600	39 x 27 x 31
MN995*	Steel Chassis	12	1000	39 x 27 x 31
MN998*	Plywood	16	600	43 x 30 x 34
MN999*	Steel Chassis	16	1000	43 x 30 x 34
STRAIGHT WALL				
MN996	Plywood	14	600	46 x 28 x 31
MN997	Steel Chassis	14	1000	46 x 28 x 31
M0001	Plywood	22	600	57 x 34 x 33
M0002	Steel Chassis	22	1000	57 x 34 x 33
M0003	Plywood	25	600	51 x 33 x 39
M0004	Steel Chassis	25	1000	51 x 33 x 39

*Stackable for storage

DURACART BOX TRUCK

- Recessed plywood undercarriage
- Molded-in handles protect hands and provide easier steering
- Rounded corners absorb impact
- Can be stacked 9 high for storage and shipping purposes
- Weight Capacity: 400 lbs.
- Bin Material: Polyethylene
- Colour: Blue
- Casters: 2 swivel & 2 stationary



TECHSTAR PLASTICS INC.

Model No.	Dimensions W" x L" x H"	Capacity cu. ft.	Volume Bushels
M0264	28 x 43 x 30-1/2	12	10
M0265	30 x 45 x 31-1/2	15	12
M0266	31 x 46 x 36-19/32	16	14

HEAVY-DUTY POLYETHYLENE BOX TRUCKS

- Seamless durable 100% polyethylene bins
- Leakproof and easy to clean
- Available with 3/4" treated plywood undercarriage or all-welded steel chassis with a durable Kleton blue enamel finish
- Includes 2 swivel and 2 rigid casters
- Capacity is based on evenly distributed weight
- Stackable for storage
- Caster type: 3" Polyolefin
- Bin colour: Black
- Bin material: Polyethylene
- Caster placement: Corner standard
- Tapered walls



KLETON

Model No.	Base	Capacity Cu. ft.	lbs.	Overall Dimensions L" x W" x H"
MN984	Plywood	9	500	37 x 26 x 30
MN985	Steel Chassis	9	800	37 x 26 x 30
MN986	Plywood	12	500	39 x 27 x 30
MN987	Steel Chassis	12	800	39 x 27 x 30
MN988	Plywood	16	500	43 x 30 x 33
MN989	Steel Chassis	16	800	43 x 30 x 33

LIGHT-DUTY POLYETHYLENE BOX TRUCKS

- Designed for lighter loads
- Rotomolded from black recycled plastic
- All-swivel threadguard casters
- NA005 includes a plywood base



TECHSTAR PLASTICS INC.

Model No.	Capacity Cu. ft.	lbs.	Overall Dimensions L" x W" x H"	Caster Size"	Weight lbs.
NG697	9	175	36 1/2 x 24 1/2 x 26	2 1/2	23
NA005	12	200	39 x 27 x 29	3	30

HEAVY DUTY ELEVATED STARCARTS™

- Built for heavy loads
- Large 4" all-swivel threadguard casters
- Power coated reinforced steel frame
- Removable plastic body
- Bin material: Polyethylene
- Colour: Blue



TECHSTAR PLASTICS INC.

Model No.	Capacity Cu. ft.	lbs.	Inside Dimensions L" x W" x H"	Overall Dimensions L" x W" x H"
M0007	3	800	45 x 22 x 5	48 x 24 x 34
M0006	5	800	35 x 23 x 10	39 x 27 x 29
M0008	9	1000	45 x 22 x 15	48 x 24 x 36

TILT TRUCKS & HOPPERS

POLYETHYLENE TILT TRUCKS

- Ideal for transporting and dumping waste, scrap and other bulk materials
- Polyethylene body is mounted on an all-welded steel chassis
- Includes small swivel caster(s) at the front and large fixed wheels at the rear



MN980



MN982



MN981



MN983



Model No.	Durability	Overall Dimensions			Capacity		Front Wheel Type	Rear Wheel Type
		L" x W" x H"	Cu. yd.	lbs.				
MN980	Light Duty	57 x 28 x 38	5/8	500	8" Mold-On Rubber	4" Non-Marking Rubber		
MN981	Standard Duty	57 x 28 x 38	5/8	850	10" Mold-On Rubber	5" Non-Marking Rubber		
MN982	Standard Duty	66 x 34 x 43	1.1	1250	12" Mold-On Rubber	5" Non-Marking Rubber		
MN983	Heavy Duty	66 x 34 x 43	1.1	2000	12" Mold-On Rubber	5" Non-Marking Rubber		

STRUCTURAL FOAM TILT TRUCKS

- Size and shape is designed to fit through commercial doorways and elevators
- Ergonomically designed steering handle provides excellent manoeuvring and dumping capabilities
- Secondary handle, at the base, helps maintain control of the truck while finishing dumping action
- Models **MK757**, **ML534** and **ML536** feature quiet rolling non-marking grey casters and 12" wheels
- Models **MK758**, **ML535** and **ML537** have 12" black rubber wheels
- Colour: Black



MK757



Model No.	Capacity		Dimensions			Wt. lbs.
	Cu. Yds.	lbs.	L" x W" x H"			
ML534	1/2	450	57 1/2 x 26 3/4 x 33 3/4	87		
ML535	1/2	850	57 1/2 x 26 3/4 x 33 3/4	96		
MK757	3/4	600	64 1/2 x 30 1/4 x 38	92		
MK758	3/4	1000	64 1/2 x 30 1/4 x 38	99		
ML536	1	1250	70 3/4 x 33 1/2 x 42 1/4	139		
ML537	1	2100	70 3/4 x 33 1/2 x 42 1/4	141		

DOMED LIDS

ML538	Domed lid for ML534 and ML535
MK780	Domed lid for MK757 and MK758
ML539	Domed lid for ML536 and ML537

POLYETHYLENE TILT TRUCKS

- Sturdy, rotationally-molded plastic construction ensures easy manoeuvrability and dumping
- Smooth surface is easy to clean and resists pitting and corroding
- Inset wheel and axle design helps prevent damage to surfaces and equipment
- Colour: Black
- Accepted for use in Canadian food processing facilities



MK769



Model No.	Capacity		Dimensions			Wt. lbs.
	Cu. Yds.	lbs.	L" x W" x H"			
MK788	1/2	450	56 3/4 x 28 x 38 1/2	63		
MK769	1/2	850	60 1/2 x 28 x 38 1/2	77		
MK789	1	850	72 1/4 x 33 1/2 x 43 3/4	111		
MK770	1	1250	72 1/4 x 33 1/2 x 43 3/4	111		
MK790*	1	2100	72 1/4 x 33 1/2 x 43 3/4	178		

RECYCLING TILT TRUCKS

ML540	1/2	850	60 1/2 x 28 x 38 1/2	77
-------	-----	-----	----------------------	----

LIDS

ML541	Lid for MK788 and MK769
ML542	Lid for MK789, MK770 and MK790

* Towable tilt truck features tow hitch and hitch pin

TILT TRUCKS & HOPPERS

STEEL SELF-DUMPING HOPPERS

- Fork lift-operated self-dumping hoppers
- Designed specifically for efficient handling of scrap metal, raw materials and other bulk materials
- Available in capacities ranging from 1/2 to 5 cubic yards
- Can be fitted with casters for better mobility
- Standard 10-gauge thickness, heavy-duty 3/16" thickness or extra heavy-duty 1/4" steel construction
- Colour: Blue
- Casters not included
- F.O.B. Laval, QC or Winnipeg, MB



MN951



Hoppers roll forward when unlatched for easy dumping



Hoppers can be used with casters, a forklift truck or both

APPLICATION GUIDELINE

Standard 10-gauge (9/64"):

Heavy-Duty 7-gauge (3/16"):

Extra Heavy-Duty 3-gauge (1/4"):

General use, factory waste and small metal parts.
Rugged use, heavy duty metals in construction field.
For extreme conditions, heavy material dropped in container. Handling of hot materials, in refineries.

Capacity Cu. Yards	Standard 10-ga. (9/64")		Heavy-Duty 7-ga. (3/16")		Extra Heavy-Duty 3-ga. (1/4")	
	F.O.B. Laval, QC Model No.	F.O.B. Winnipeg, MB Model No.	F.O.B. Laval, QC Model No.	F.O.B. Winnipeg, MB Model No.	F.O.B. Laval, QC Model No.	F.O.B. Winnipeg, MB Model No.
1/2	NB949	MN951	NB950	MN952	NB948	MN953
3/4	NB955	MN954	NB956	MN955	NB954	MN956
1	NB967	MN957	NB968	MN958	NB966	MN959
1-1/2	NB961	MN960	NB962	MN961	NB960	MN962
2	NB973	MN963	NB974	MN964	NB972	MN965
3	NB979	MN966	NB980	MN967	NB978	MN968
4	NB985	MN969	NB986	MN970	NB984	MN971
5	NH094	MN972	NH095	MN973	NH096	MN974

CASTER SETS FOR HOPPERS (F.O.B. LAVAL, QC)

- Set includes 2 rigid and 2 swivel casters

Model No.	Wheel Type
NB987	6" Phenolic
NB988	6" Rubber
NB989	6" Steel

CASTER SETS FOR HOPPERS (F.O.B. WINNIPEG, MB)

- Set includes 2 rigid and 2 swivel casters

Model No.	Wheel Type
M0033	4" Polyurethane
M0034	5" Polyurethane
M0035	6" Polyurethane

KNOCKED-DOWN SELF-DUMPING HOPPERS

- Economical alternative to all-welded self-dumping hoppers
- Ships knocked down in a well packaged wood crate
- Simply bolt together panels, gears and latch to the fully assembled base
- Fork lift-operated self-dumping hopper
- Designed specifically for efficient handling of scrap metal, raw materials and other bulk materials
- Spring loaded (pull-down) lever system, safe when dumping at heights and can be dumped from the ground
- Removable pin system allows for easy, user friendly repairs
- 12-gauge panels can easily be replaced (Panels sold separately)
- Material: Galvanized Steel
- Base Thickness: 7 Gauge
- Load Capacity: 2000 lbs.



MO130

KLETON

Model No.	Dimensions			Capacity cu. yd.
	W"	x D"	x H"	
M0130	39	x 44-3/4	x 28-1/2	5/8
M0131	48-1/2	x 50	x 31	1
M0132	61-1/2	x 55	x 34	1-1/2
M0247	Caster Set			

POLYETHYLENE SELF-DUMPING HOPPERS

- Tilt a full 30° below horizontal level to ensure complete dumping
- Pull-release safety latch prohibits premature dumping
- Used on a fork lift truck for elevated dumping or with polyolefin casters
- Smooth interior will not support bacteria growth and can be cleaned by steam or pressure washer
- Black body will not rust, corrode or pit
- Weight is 1/3 that of steel
- Ideal for compounding chemical powders, resins and granular materials
- Also ideal for the bulk handling of refuse
- Four 6" polyolefin casters available for all sizes



MK760 (with casters)



Model No.	Mfg. No.	Capacity		Dimensions			With Casters	Wt. lbs.
		Cu. Yds.	lbs.	L"	x W"	x H"		
MK759	1054	1/2	750	55	x 26 1/4	x 40	-	173
MK760	1054-43	1/2	750	55	x 26 1/4	x 47 5/8	Yes	202
MK761	1059	1	1000	71 1/2	x 31 1/4	x 44 7/8	-	224
MK762	1059-43	1	1000	71 1/2	x 31 1/4	x 52 1/2	Yes	251
MK763	1064	1 1/2	1000	83 5/8	x 42 7/8	x 49 1/8	-	307
MK764	1064-43	1 1/2	1000	83 5/8	x 42 7/8	x 56 1/4	Yes	361
MK765	1069	2	1000	83 7/8	x 46	x 49 1/2	-	303
MK766	1069-43	2	1000	83 7/8	x 46	x 57 5/8	Yes	344
MK767	1074	2 1/2	1000	83 1/2	x 55	x 49 1/2	-	305
MK768	1074-43	2 1/2	1000	83 1/2	x 55	x 56 5/8	Yes	368

CASTERS

POLYOLEFIN CASTERS

- Rolls easily on most floors
- Lightweight and economical
- Non-marking, easy to maintain, steam cleanable
- High impact strength
- Superior resistance to most oils, chemicals, grease and acids

Model No.	Wheel Dia."	Style	Cap. lbs.	Tread Width"	Overall Height"
ML391	3	Swivel	250	1 1/4	4 1/2
ML392	3	Rigid	250	1 1/4	4 1/2
ML393	4	Swivel	250	1 1/4	5 1/4
ML394	4	Rigid	250	1 1/4	5 1/4
ML395	5	Swivel	250	1 1/4	6 1/8
ML396	5	Rigid	250	1 1/4	6 1/8

SURFACE APPLICATIONS:
Concrete, brick, carpet and steel

Plate size: 2 5/8" x 3 3/4"
Bolt hole centres: 1 3/4" x 2 7/8"
Bolt hole size: 5/16"



ML391



ML394

BLUE ELASTIC RUBBER CASTERS

- High load capacity, rolls easily and quietly on all floors
- Non-marking, excellent floor protection
- Zinc chrome plated finish provides corrosion resistance
- Elastic rubber tread rejects floor debris
- Sealed double ball raceway
- Thread guards
- Ball bearing

Model No.	Wheel Dia."	Style	Cap. lbs.	Tread Width"	Overall Height"
ML333	4	Swivel	350	1 3/8	5
ML334	4	Rigid	350	1 3/8	5
ML342	4	Swivel W/Brake	350	1 3/8	5
ML337	5	Swivel	400	1 3/8	6
ML338	5	Rigid	400	1 3/8	6
ML345	5	Swivel W/Brake	400	1 3/8	6

SURFACE APPLICATIONS:
Concrete, brick, carpet, steel, tile, asphalt, wood and linoleum

Plate size: 3 3/8" x 4"
Bolt hole centres: 2 3/8" x 3 1/8"
Bolt hole size: 5/16"



ML342



ML333



ML334

NYLON SANDWICH CASTERS

- Non-marking white nylon elastic rubber cushion ring layer reduces noise and vibration
- Chrome zinc-finish for corrosion resistance
- Double raceway
- Ball bearing
- Brake type: Total locking

Model No.	Wheel Dia."	Style	Cap. lbs.	Tread Width"	Overall Height"
MN441	4	Swivel	440	1 3/8	5 1/8
MN442	4	Rigid	440	1 3/8	5 1/8
MN443	4	Swivel W/Brake	440	1 3/8	5 1/8
MN444	5	Swivel	440	1 3/8	6 1/8
MN445	5	Rigid	440	1 3/8	6 1/8
MN446	5	Swivel W/Brake	440	1 3/8	6 1/8

SURFACE APPLICATIONS:
Concrete, brick, carpet and steel

Plate Size: 3 1/3" x 4 1/8"
Bolt hole centres: 3 1/8" x 2 1/3"
Bolt hole size: 5/16"



MN443



MN441



MN442

POLYURETHANE CASTERS

- Smooth rolling, low noise operation
- Non-marking, cut & tear resistant
- Die cast aluminum core with brown polyurethane tread
- Resistant to most chemicals, moisture friendly
- Double ball raceway
- Annular ball bearing

Model No.	Wheel Dia."	Style	Cap. lbs.	Tread Width"	Overall Height"
ML044	3	Swivel	230	1 1/4	4 1/4
ML043	3	Rigid	230	1 1/4	4 1/4
ML045	4	Swivel	440	1 1/2	5 3/8
ML046	4	Rigid	440	1 1/2	5 3/8
ML441	4HD	Swivel	550	1 5/8	5 5/8
ML442	4HD	Rigid	550	1 5/8	5 5/8
MN264	4HD	Swivel w/brake	550	1 5/8	5 5/8
ML397	5	Swivel	650	1 1/2	6 1/2
ML398	5	Rigid	650	1 1/2	6 1/2
MN265	5	Swivel w/brake	650	1 1/2	6 1/2
ML399	6	Swivel	850	1 1/2	7 1/2
ML400	6	Rigid	850	1 1/2	7 1/2
MN266	6	Swivel w/brake	850	1 1/2	7 1/2
MN449	6	Butterfly side brake	850	1 1/2	7 1/2
ML401	8	Swivel	1000	1 5/8	9 1/2
ML402	8	Rigid	1000	1 5/8	9 1/2
MN267	8	Swivel w/brake	1000	1 5/8	9 1/2
MN450	8	Butterfly side brake	1000	1 5/8	9 1/2

SURFACE APPLICATIONS:
Concrete, brick, carpet, steel, tile, asphalt, wood and linoleum

Plate size:
3 = 2 5/8" x 3 3/4"
4 = 3 1/8" x 4 1/8"
4 HD = 4" x 4 1/2"
5 = 4" x 4 1/2"
6 = 4" x 4 1/2"
8 = 4" x 4 1/2"

Bolt hole centres:
3 = 1 3/4" x 2 3/4"
4 = 2 3/8" x 3 1/16"
4 HD = 3 1/4" x 2 3/4"
5 = 3 1/4" x 2 3/4"
6 = 3 1/4" x 2 3/4"
8 = 3 1/4" x 2 3/4"

Bolt hole size:
3 = 5/16"
4 = 5/16"
4 HD = 3/8"
5 = 3/8"
6 = 3/8"
8 = 3/8"



ML043



ML044



MN264



MN450



HI-TEMP NYLON CASTERS

- Smooth rolling, non-marking
- Zinc chrome plated finish provides corrosion resistance
- Superior resistance to most oils, chemicals, and grease
- Double ball raceway
- Ball bearing
- Total lock brake
- Brake type: Total Locking

SURFACE APPLICATIONS:
Concrete, brick, carpet and steel
Plate Size: 4" x 4 1/2"
Bolt hole centers: 3" x 3 1/3"
Bolt hole size: 7/16"



Model No.	Wheel Dia."	Style	Cap. lbs.	Tread Width"	Overall Height"
ML861	6	Swivel	800	1 3/4	7 5/8
ML862	6	Rigid	800	1 3/4	7 5/8
ML863	6	Swivel W/Brake	800	1 3/4	7 5/8
MN453	6	Butterfly side brake	800	1 3/4	7 5/8
ML864	8	Swivel	850	1 3/4	9 1/2
ML865	8	Rigid	850	1 3/4	9 1/2
ML866	8	Swivel W/Brake	850	1 3/4	9 1/2
MN454	8	Butterfly side brake	850	1 3/4	9 1/2



MOLD-ON RUBBER CASTERS

- Molded rubber wheel permanently bonded to spoked cast iron core
- Iron centre gives it strength while the molded rubber offers smooth and quiet operation
- Protects loads and surfaces
- Won't damage warehouse or factory floors
- Brake type: Total Locking

SURFACE APPLICATIONS:
Concrete, brick, carpet, steel, tile, asphalt, wood and linoleum
Plate Size: 4" x 4 1/2"
Bolt hole centers: 2 7/8" x 3 1/3"
Bolt hole size: 7/16"



Model No.	Wheel Dia."	Style	Cap. lbs.	Tread Width"	Bearing Type"
ML846	5	Swivel	400	2	Roller
ML847	5	Rigid	400	2	Roller
ML849	6	Swivel	500	2	Roller
ML850	6	Rigid	500	2	Roller
ML851	6	Swivel w/Brake	500	2	Roller
MN451	6	Butterfly side brake	500	2	Roller
ML852	8	Swivel	600	2	Roller
ML853	8	Rigid	600	2	Roller
ML854	8	Swivel w/Brake	600	2	Roller
MN452	8	Butterfly side brake	600	2	Roller



PNEUMATIC CASTERS

- Four ply pneumatic casters offer smooth and quiet rolling over the roughest surfaces and outdoor terrain
- Shock absorbing properties give the greatest possible protection to both the load and floor
- The "Air cushion" feature will transport the most fragile material and instruments without damage
- Not recommended for floors with metal shavings or corrosive chemicals

SURFACE APPLICATIONS:
Concrete, brick, carpet, steel, tile, asphalt, wood and linoleum
Plate Size: 4" x 4 1/2"
Bolt hole centers: 2 3/4" x 3 3/8"
Bolt hole size: 13/32"



Model No.	Wheel Dia."	Style	Cap. lbs.	Tread Width"	Overall Height"
MN222	8	Swivel	350	2	10
MN221	8	Rigid	350	2	10
MN224	10	Swivel	400	3	12
MN223	10	Rigid	400	3	12

Note: For optimum use pneumatic wheels must be properly inflated



MN222

MN221

FLAT-FREE CASTERS

- Solid polyurethane wheel never runs flat
- Same bounce feel and weight of a pneumatic caster
- Smooth and quiet rolling over rough terrain and surfaces
- Less costly than traditional foam-filled tires
- Ball bearing

SURFACE APPLICATIONS:
Concrete, brick, carpet, steel, tile, asphalt, wood and linoleum
Plate Size: 4" x 4 1/2"
Bolt hole centers: 2 3/4" x 3 3/8"
Bolt hole size: 13/32"



Model No.	Wheel Dia."	Style	Cap. lbs.	Tread Width"	Overall Height"
MN226	8	Swivel	275	2	10
MN225	8	Rigid	275	2	10
MN228	10	Swivel	300	3	12
MN227	10	Rigid	300	3	12



MN228

MN227

PALLET TRUCKS

HEAVY-DUTY SERIES

Rugged construction makes these pallet trucks the best value for your material handling needs. Forks feature entry rollers and tapered design for easy pallet entry and are reinforced for heavy-duty loads. The 3-function hand control (raise, neutral and lower) and the spring-loaded self-righting safety loop handle enhance comfort and ease of operation. Hardened chrome piston with protective dust cover for dependable performance. Durable powder coat finish.

HYDRAULIC PALLET TRUCKS

- Heavy-duty polyurethane tread bonded to cast iron core steering wheels and rollers provide superior performance
- 6 1/4" (158.75 mm) wide forks
- Orange
- **2-year limited warranty**



KLETON

Model No.	Forks		Frame Width"	Fork Length"	Capacity lbs.
	Lowered"	Raised"			
MJ484	27/8	7 3/4	20 1/2	36	5500
MJ485	27/8	7 3/4	20 1/2	42	5500
MJ486	27/8	7 3/4	20 1/2	48	5500
MJ487	27/8	7 3/4	27	36	5500
MJ488	27/8	7 3/4	27	42	5500
MJ489	27/8	7 3/4	27	48	5500
ML372*	27/8	7 3/4	27	48	5500

* Heavy-duty nylon wheels

HYDRAULIC PALLET TRUCKS

- Heavy-duty polyurethane tread bonded to cast iron core steering wheels and rollers provide superior performance
- Double rollers for easy moving of extra heavy loads
- Reinforced fork channels deliver exceptional durability
- 6 1/4" (158.75 mm) wide forks
- Kleton blue
- **2-year limited warranty**



Forks feature double entry rollers and tapered design for easy pallet entry



KLETON

Model No.	Forks		Frame Width"	Fork Length"	Capacity lbs.
	Lowered"	Raised"			
MJ490	27/8	7 3/4	20 1/2	36	6600
MJ491	27/8	7 3/4	20 1/2	42	6600
MJ492	27/8	7 3/4	20 1/2	48	6600
MJ493	27/8	7 3/4	27	36	6600
MJ494	27/8	7 3/4	27	42	6600
MJ495	27/8	7 3/4	27	48	6600
ML373*	27/8	7 3/4	27	48	6600

* Heavy-duty nylon wheels

STANDARD-DUTY HYDRAULIC PALLET TRUCKS

- Heavy-duty polyurethane tread bonded to cast iron core steering wheels and rollers provide superior performance
- Heavy-duty plastic rollers facilitate entry and exit of pallets
- 6 1/4" (158.75 mm) wide forks
- Yellow
- **1-year limited warranty**



KLETON

Model No.	Forks		Frame Width"	Fork Length"	Capacity lbs.
	Lowered"	Raised"			
ML966	3 1/4	7 3/4	20 1/2	36	5500
ML967	3 1/4	7 3/4	20 1/2	42	5500
ML968	3 1/4	7 3/4	20 1/2	48	5500
ML969	3 1/4	7 3/4	27	36	5500
ML970	3 1/4	7 3/4	27	42	5500
ML971	3 1/4	7 3/4	27	48	5500
ML972*	3 1/4	7 3/4	27	48	5500

* All nylon core steering wheels and rollers

SUPER HEAVY-DUTY HYDRAULIC PALLET TRUCKS

- Extra heavy-duty all steel steering wheels and rollers provide maximum mobility and performance
- Double rollers for easy moving of extra heavy loads
- Heavy-duty plastic exit rollers facilitate entry and exit of pallets
- 6 1/4" (158.75 mm) wide forks
- Dark blue
- **2-year limited warranty**



KLETON

Model No.	Forks		Frame Width"	Fork Length"	Capacity lbs.
	Lowered"	Raised"			
ML994	3	7 3/8	27	48	11 000

6' LONG FORK HYDRAULIC PALLET TRUCKS

- Heavy-duty polyurethane thread bonded to cast iron core steering wheels and rollers provide superior performance
- Nylon exit roller facilitates entry and exit of pallets
- 6 1/4" (158.75 mm) wide forks
- Lowered pallet truck height: 3"
- Raised pallet truck height: 7 5/8"
- Capacity: Up to 5500 lbs.
- Yellow
- **2-year limited warranty**



KLETON

Model No.	Fork Width"	Fork Length"
MN459	27	72

LOW PROFILE HYDRAULIC PALLET TRUCKS

- Permits the handling of pallets and containers that are lower than the standard height
- Heavy-duty polyurethane tread bonded to cast iron core steering wheels and all steel rollers provide superior performance
- 1.5" exit ramp facilitates exit of pallets
- 6" (152 mm) wide forks
- Lowered pallet truck height: 2"
- Raised pallet truck height: 5 1/2"
- Orange
- **2-year limited warranty**



KLETON

Model No.	Frame Width"	Fork Length"	Capacity lbs.
MN061	27	48	5500

MULTI-DIRECTIONAL HYDRAULIC PALLET TRUCKS

- Transrollers permit lateral movement in addition to forward/backward
- Heavy-duty polyurethane tread bonded to cast iron core steering wheels provide superior performance
- Double load rollers, one polyurethane tread bonded to cast iron core and one nylon for easy moving of extra heavy loads
- 2 1/5" exit ramp facilitates exit of pallets
- 6 1/4" (158.75 mm) wide forks
- Lowered pallet truck height: 3"
- Raised pallet truck height: 7 1/2"
- Capacity: Up to 5500 lbs. in standard mode and up to 3300 lbs. in lateral mode
- Orange
- **2-year limited warranty**

KLETON

Model No.	Frame Width"	Fork Length"
MN062	27	48



DIGITAL SCALE PALLET TRUCKS

- Permits the weighing of skids and containers while handling them
- Mettler Toledo digital cUL approved scale offers maximum precision on load weights
- Heavy-duty polyurethane tread bonded to cast iron core steering wheels and rollers provide superior performance
- Nylon roller facilitates entry and exit of pallets
- Fork width: 6-5/8"
- Orange
- **2-year limited warranty**

KLETON

Model No.	Fork Height Lowered"	Fork Height Raised"	Frame Width"	Fork Length"	Capacity lbs.
MN705	3	7.68	27	44.5	4400



GALVANIZED HYDRAULIC PALLET TRUCKS

- Heavy-duty all nylon steering wheels and rollers provide superior mobility and performance
- Nylon exit roller facilitates entry and exit of pallets
- 6 1/4" (158.75 mm) wide forks
- Lowered pallet truck height: 3"
- Raised pallet truck height: 7 1/16"
- Galvanized finish offers corrosion resistance and is ideal for wet and cold conditions
- **2-year limited warranty**

KLETON

Model No.	Frame Width"	Fork Length"	Capacity lbs.
MN059	27	48	5500
MN648	27	42	5500



STAINLESS STEEL HYDRAULIC PALLET TRUCKS

- Heavy-duty all nylon steering wheels and rollers provide superior mobility and performance
- Nylon exit roller facilitates entry and exit of pallets
- 6 1/4" (158.75 mm) wide forks
- High grade 304 stainless steel is ideal for medical, food, sanitary, pharmaceutical, wet and cold applications
- **2-year limited warranty**

KLETON

Model No.	Fork Height Lowered"	Fork Height Raised"	Frame Width"	Fork Length"	Capacity lbs.
MN060	3	7 1/16	27	48	5500



4-WAY HYDRAULIC PALLET TRUCKS

- Can enter pallet from all four sides
- Reinforced forks
- Adjustable fork connecting rods
- Steel 1.70" load wheels
- 6" polyurethane steering wheels
- **3-year limited warranty**

WESCO

Model No.	Frame Width"	Fork Length"	Capacity lbs.
MN136	33	48	4000



ECO I-55 AUTOMOTIVE BRAKE PALLET TRUCK

- Quality german-designed pump
- 200° handle pivot
- Ergonomic cushioned handle
- 3-position finger tip control
- High-quality powder coat finish
- Polyurethane wheels and load rollers
- Fork width: 6.3"
- Raised height: 7.9"
- Lowered height: 2.9"

MOBILE

Model No.	Frame Width"	Fork Length"	Capacity lbs.
LU002	27	48	5500



PALLET TRUCKS

ADJUSTABLE WIDTH PALLET TRUCKS

- Overall fork width adjusts from 21" to 27"
- Fork length: 48"
- 7" mold-on polyurethane steering wheel
- 3" mold-on polyurethane load wheels
- 6" (152 mm) wide forks
- Raised height: 7 3/4"
- Lowered height: 3"
- Capacity: 5500 lbs.
- **5-year limited warranty**

Model No. MI820

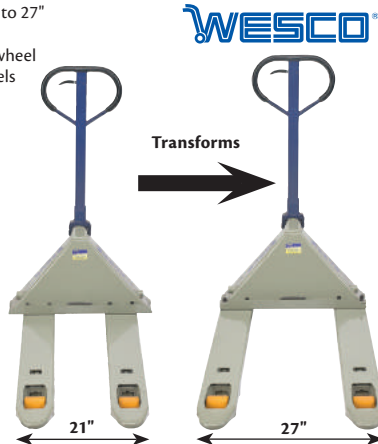

WESCO®

ALL TERRAIN PALLET TRUCKS

- Welded steel tubular frame construction for maximum strength
- Features large pneumatic wheels for use on gravel, dirt and other types of rough terrain
- Wheels include sealed bearings for dust protection and long life
- Overall fork length: 32"
- Fork lowered height: 3"
- Fork raised height: 9"
- Overall dimensions: 64" W x 50" L x 51" H
- Usable straddle width is 50" between outriggers
- Rear wheel diameter: 10"
- **90-day limited warranty**



MN461

Model No.	Capacity lbs.	Overall Fork Width	Wt. lbs.
MN461	2000*	9 1/2" - 26"	239
MN462	2500**	10" - 26 3/4"	457
MN463	Optional Tow Bar Package		20

* 2,000 lbs. at 12" horizontal load center, 1,500 lbs. at 15" and 1,000 lbs. at 24".
 ** 2,500 lbs. at 12" horizontal load center, 2,000 lbs. at 15" and 1,500 lbs. at 24".

QUICK LIFT HYDRAULIC PALLET TRUCKS

- Maximize operator efficiency with this quick-lift pallet truck
- Lifts to full height with only four pumps when empty
- 2-speed pump automatically switches to low-speed operation
- Allows forks to quickly rise to upper pallet boards for quicker operation
- Each fork measures 6 1/4" wide
- Poly-on-steel wheels are the best in the industry
- **90-day limited warranty**



Model No.	Fork Height Lowered"	Fork Height Raised"	Frame Width"	Fork Length"	Capacity lbs.
MN365	3	7 1/2	20	48	5500
MN366	3	7 1/2	27	48	5500

PALLET TRUCK CADDIES

- Durable molded plastic
- Economical product will convert a standard pallet truck into a portable workstation in minutes
- Overall dimensions: 16 1/4" W x 7 3/4" D x 18 5/8" H
- **Includes:** Tool pockets on each side, pen and pencil tray, clipboard holder, built-in cup or can holder, and storage compartment

Model No. MN368



4-WAY HYDRAULIC PALLET TRUCKS

- Can enter pallet from all 4 sides
- Reinforced forks
- Adjustable fork connecting rods
- Steel 1.70" load wheels
- 6" polyurethane steering wheels
- Capacity: 4000 lbs.
- **3-year limited warranty**



WESCO®

Model No.	Frame Width"	Fork Length"	Wt. lbs.
MN136	33	48	241

ECO I-55 AUTOMOTIVE BRAKE PALLET TRUCKS

- Formed C-channel steel
- Reinforced forks
- Quality German-designed pump
- Heavy-duty thrust plate
- Ergonomic cushioned handle
- 3-position finger tip control
- Adjustable push rods
- High-quality powder coat finish
- 200° handle pivot
- Rubber wheels and polyurethane load rollers
- Capacity: 5500 lbs.
- Fork Width: 6.3"



LU001

Model No.	Fork Height Lowered"	Fork Height Raised"	Fork Length"	Frame Width"
LU001	2.9	7.9	48	20.5
LU002	2.9	7.9	48	27

LIFT-RITE® TITAN PALLET TRUCKS

- New one-piece pump for improved performance and reliability
- Includes ergonomic handles and articulating steering wheels
- 7" wide forks
- Fork lowered height: 3"
- Fork raised height: 7 3/4"
- **2-year limited warranty**



Model No.	Frame Width"	Fork Length"	Capacity lbs.
ML052	20 1/2	36	5500
ML053	20 1/2	42	5500
ML054	20 1/2	48	5500
ML055	27	36	5500
ML056	27	42	5500
ML057	27	48	5500

Custom sizes available

FORKLIFT ACCESSORIES

FORK EXTENSIONS

- Handle large and odd shaped loads with increased stability
- Easy to use slide-on design
- Steel retaining strap prevents extensions from sliding off forks during use
- Fork extension not to exceed 50% more than existing fork length
- Available in 4" and 5" fork widths, with lengths of 72" and 96"



KLETON

Model No.	Accommodates Fork Width"	Fork Extension Overall Width"	Length"	Wt. lbs.
ML346	4	5	72	105
ML347	5	6	72	116
ML348	4	5	96	140

FORK EXTENSIONS

- Handle large and odd shaped loads with increased stability and minimum damage
- Available in 4", 5" and 6" fork widths, lengths are from 54" to 96"
- Easy to use slide-on design
- Fork fits up to 2" thick
- Convenient on/off design
- Locking bar keeps extensions in place
- Fork extension not to exceed 50% more than existing fork length



Model No.	Accommodates Fork Width"	Fork Extension Overall Width"	Length"	Max. Fork Thickness"	Wt. lbs.
MF775	4	5	54	2	84
MF776	4	5	63	2	98
MF778	4	5	84	2	124
MF781	5	6	54	2	96
MF782	5	6	63	2	110
MF784	5	6	84	2	129
MF785	5	6	96	2	158
MF787	6	7	54	2 1/2	104
MF788	6	7	63	2 1/2	116
MF789	6	7	72	2 1/2	134
MF790	6	7	84	2 1/2	156
MF791	6	7	96	2 1/2	181

Also available: Add-on for optional pins style fork extension and other lengths.

FORKLIFT MIRRORS

- Know what is going on all around the lift truck at all times
- High range of visibility
- Installation on any lift truck is quick and easy

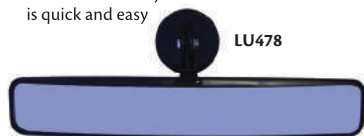

Model No.	Size	Mounting Type
RECTANGULAR		
LU478	18-1/4" W x 3" H	Magnet
LU479	8" W x 4-1/4" H	Magnet

Model No.	Size	Mounting Type
DOMES		
LU442	9" Dia.	Tape
LU443	9" Dia.	Magnet

WALL BRACKETS

- All welded heavy-duty
- To keep fork extensions out of the way when not in use
- One wall bracket required for each pair of forks
- Kleton safety yellow

KLETON

Model No.	Dimensions W" x H"	Wt. lbs
ML282	6 x 8	5

Hardware not included

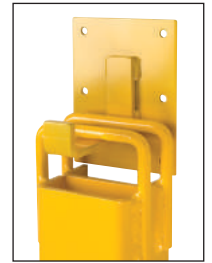

PALLET PULLERS

- Efficient way to unload pallets from trucks
- Hardened teeth give positive grip in any pallet
- One-person operation
- Pulls pallets straight or sideways to get out of tight spots
- Capacity: 5000 lbs.



KH863



LU982
OPTIONAL 20'
HOOK AND CHAIN

KLETON

Model No.	Description	Wt. lbs.
KH863	Pallet Puller	16
LU982	20' Hook and Chain	5

FORKLIFT CHECKLIST CADDY KIT

- A complete daily forklift checklist system for forklift operators
- OSHA requires that all forklifts be inspected before the beginning of each shift
- Includes one 75 inspection carbon copy sheet checklist pad
- Includes one pen with attached plastic wire
- Includes one Caddy 4-1/2" x 7" polyethylene envelope with two-way tape for easy mounting



Model No.	Forklift Type	Version	Language
LU454	Propane Counterbalance	Complete Log Kit	English
LU455	Electric Counterbalance	Complete Log Kit	English
LU456	Electric Narrow Aisle	Complete Log Kit	English
LU457	Electric Pallet Truck	Complete Log Kit	English
LU458	Aerial Work Platform	Complete Log Kit	English
LU468	Propane Counterbalance	Complete Log Kit	French
LU469	Electric Counterbalance	Complete Log Kit	French
LU470	Electric Narrow Aisle	Complete Log Kit	French
LU471	Electric Pallet Truck	Complete Log Kit	French
LU472	Aerial Work Platform	Complete Log Kit	French
LU459	Propane Counterbalance	Replacement Log Book	English
LU460	Electric Counterbalance	Replacement Log Book	English
LU461	Electric Narrow Aisle	Replacement Log Book	English
LU462	Electric Pallet Truck	Replacement Log Book	English
LU463	Aerial Work Platform	Replacement Log Book	English
LU473	Propane Counterbalance	Replacement Log Book	French
LU474	Electric Counterbalance	Replacement Log Book	French
LU475	Electric Narrow Aisle	Replacement Log Book	French
LU476	Electric Pallet Truck	Replacement Log Book	French
LU477	Aerial Work Platform	Replacement Log Book	French

LIFT TABLES

HYDRAULIC SCISSOR LIFT TABLES

Kleton tables are available in various capacities and travels to satisfy a wide variety of applications. All models have an integrated hydraulic pump/cylinder assembly. The Kleton scissor lift tables add the value of mobility to the hydraulic lift table concept. Exceptional functionality and manoeuvrability is apparent, whether loaded or empty. In addition, rugged construction and premium-quality hydraulics complement their ease of use with low maintenance.

APPLICATIONS

Kleton tables are used in a wide variety of applications, from stocking shelves in retail stores to lifting and moving materials in warehouses, machine shops and manufacturing operations.

OPERATION

The Kleton design allows workers to easily move and position loads to a convenient working height. By minimising undesirable lifting, reaching and stretching, Kleton tables increase productivity and decrease workplace injuries.



STANDARD FEATURES

- Heavy-duty construction with captured scissor rollers for maximum stability
- Superior hydraulic systems feature an integrated pump-cylinder for maximum reliability
- High quality casters and wheels for exceptional roll ability (two fixed, two swivel)
- Ergonomic push handle with convenient lowering control
- Lowering control automatically stops when released for added safety
- Convenient maintenance pins secure the scissor legs for inspection and maintenance on larger models
- Quality powder coated finish provides exceptional durability and corrosion resistance
- Kleton blue



Model No.	Load Cap. lbs.	Platform Height		Platform Dimensions		Handle Height"	Pedal Strokes To Max	Wt. lbs.
		Lowered"	Raised"	Width"	Length"			
MJ518	330	8 5/8	29	17 3/4	27 1/2	37 3/8	28	99
MJ519	660	11 1/4	34 5/8	19 3/4	32	39	27	170
MJ520*	770	14	51 1/4	19 3/4	35 3/4	38 3/8	53	230
MJ521	1100	11 1/4	34 5/8	19 3/4	32	39	27	179
MJ522	1100	11 1/4	36	31 7/8	63	39	55	340
MJ523	1650	16 1/2	35 3/8	20 1/8	39 3/8	39 3/8	45	275
MJ524	2200	15	39	20 1/8	40	38 5/8	82	269
MJ525	2200	11 3/4	53 1/2	29 1/2	80 1/8	39 3/8	200	770
MJ526*	1545	17 1/2	59 1/8	24	48	40	97	430

*Double scissors

HYDRAULIC WORK TABLES

- All-welded construction
- Foot operated lifts are ideal for wide variety of shop functions (lifting dies, transporting heavy parts and positioning materials)
- Hand operated lever lowers the table level and controls the rate of descent
- Telescoping posts for stability and support
- Tops and bases are 3/16" thick steel
- Floor lock ensures table remains in place when loaded



Model No.	Table Height		Table Dimensions		Cap. lbs.	Wt. lbs.
	Lowered"	Raised"	Length" x	Width"		
MA433	28 1/2	46	16 x	16	200	54
MA434	30 1/2	47 1/2	18 x	18	500	122
MA435	30 1/2	47 1/2	18 x	36	1000	268
MA442	30 1/2	47 1/2	36 x	24	2000	225
MA443	30 1/2	47 1/2	48 x	32	2000	350

Other dimensions and capacities available

DANDY LIFT™ LIFT TABLES

- Dandy Lift™ offers the ideal solution to reliable, economic lifting over years of service
- Pivot points have hardened pins in lifetime lubricated bearings
- Simple grouped controls make tables easy to operate
- Hard chrome-plated pistons and rods resist rust and corrosion for dependability and long life
- Honed heavy-walled cylinders improve both seal performance and durability



SOUTHWORTH

Model No	Platform Height		Platform Size		Capacity lbs.
	Lowered"	Raised"	Width"	Length"	
MA431	8 3/10	29	17 7/10	28	330
MA432	9 1/2	31 4/5	19 7/10	31 1/2	550
MA421	13 3/5	49 4/5	23 3/5	35 4/5	770
MA422	11 4/5	36 3/5	23 3/5	35 4/5	1100
MA423	13	40 1/5	23 3/5	39 2/5	1760

EZ LOADER®

- Minimizes bending and lifting and reduces extra movement around the pallet
- Weight sensitive, raises and lowers pallet as load weight changes, keeping top of the load at convenient working height
- Rotating top minimizes walking or reaching during the loading process
- Allows on or off loading to be done from near side and at convenient height
- 3-position capacity, adjustable without changing air pressure
- Designed to work in conjunction with Bishamon's Unilift custom easy-to-read air gauge
- Air pressure capacity adjustment: 10-60 PSI
- Shop air requirements: Clean dry air 60 PSI
- Heavy-duty, structural steel frame is 24 1/3" x 49" at base; turntable is 43" in diameter
- Product Weight: 500 lbs.
- Lift Vertical Travel: 20"
- Min. Self Leveling Capacity: 250 lbs.
- Maximum internal air pressure: 135 PSI
- Max. Self Leveling Capacity: 3500 lbs.
- Capacity: 4000 lbs.
- Raised Height: 30.5"
- Lowered Height: 10.5"



LT459



Model No.	Mfg. No.	Description	Frame Material
LT459	EZ-LOADER	Pallet Lifter	Steel
LV437	EZ LOADER-E	Self-Levelling Pallet Positioner Stainless Platform	Steel
LV438	EZ-LOADER-SS	Self-Levelling Pallet Positioner 100% Stainless Steel	Stainless Steel

EZ X LOADER® SELF-LEVELLING PALLET POSITIONER

- Economical alternative to the standard EZ Loader
- Self-levelling design keeps top of the load at convenient working height
- Pressure relief valve prevents excess pressure build-up
- Rotating top minimizes walking or reaching during the loading process
- Rollers entrapped in base frame and platform for added stability
- Captive air operation eliminates mechanical springs
- Product Weight: 500 lbs.
- Lift Vertical Travel: 20"
- Platform Dimensions: 43" L x 43" W
- Capacity: 4000 lbs.
- Raised Height: 29.8"
- Lowered Height: 9.8"
- Frame Material: Steel

Model No. LV439
Mfg. No. EZ X Loader



SKID LIFTS

- Closed fork tips and reinforced chassis ensure long-lasting performance
- Ergonomically designed and comfortable handle
- Single cylinder for increased durability and less maintenance
- Quick-lift function
- Fork width: 6.5"
- Height: Raised: 28"
Lowered: 3.3"
- Capacity: 2200 lbs.
- Extended mast height: 65.5"
- Wheels/rollers: Polyurethane



MANUAL SCISSOR LIFTS

- Overall length: 70"

BATTERY SCISSOR LIFTS

- Turning radius: 61.5"
- Lift motor: 0.6 kW
- Battery voltage (V/Ah): 12 V/52 Ah
- Overall length: 67.5"



LU017

LU113

MANUAL

Model No.	Fork Length"	Frame Width"
LU017	46	20.5
LU018	46	27

BATTERY

Model No.	Fork Length"	Frame Width"
LU113	46	20.5
LU114	46	27

SKID LIFTS

- Allows entry into different skids and baskets
- Lightweight design is easy to manoeuvre with pallet truck style steering configuration
- Strong and reliable cylinder
- Quick-lift mechanism on manual lifts allows loads under 400 lbs. to be raised with 24 strokes, heavier loads require 72 strokes
- Self-contained battery powered power pack (electric models) eliminates power source or power cord problems
- Built-in automatic battery charger and charge indicator (electric models)

- Raised bulkhead design provides greater backrest surface, ergonomic location for automatic battery charger and clear view of load
- 24" load centre
- Lowered height: 3 1/4", raised height: 31 1/2"
- 8" polyurethane load wheels and 3" polyurethane load roller
- Capacity: 3000 lbs.



MANUAL LIFTS

Model No.	Fork Dimensions L" x W"	Wt. lbs.
MH748	48 x 20 1/2	330
MH749	48 x 27	340

ELECTRIC LIFTS

Model No.	Fork Dimensions L" x W"	Wt. lbs.
MH796	48 x 20 1/2	430
MH797	48 x 27	440

LIFT TABLES & STACKERS

SKIDLIFT™ MOBILE LOAD POSITIONER

- Scissor design provides enhanced stability
- Superior hydraulics deliver shorter lift stroke and reduce cylinder wear
- Locking foot brake allows for improved mobility
- Manual-lift available also upon request
- Lift Vertical Travel: 29.5"
- Frame Material: Steel
- Handle Height: 41.1"



Bishamon

Model No.	Mfg. No.	Height		Platform Dimensions L' x W"	Capacity lbs.
		Raised"	Lowered"		
LV456	LVE-50E	32.8	3.3	42-1/2 x 20-1/2	1000
LV457	LVE-50WE	32.8	3.3	42-1/2 x 27	1000
LV458	LVE-100E	32.8	3.3	42-1/2 x 20-1/2	2200
LV459	LVE-100WE	32.8	3.3	42-1/2 x 27	2200

LOPROFILE™ ELECTRIC-HYDRAULIC SCISSOR LIFT TABLE

- Extremely low platform lowered heights, allowing wheeled cart and pallet jack access
- Offers heavy-duty lifting power and convenient low-profile functionality
- Heavy-duty construction and captured scissor rollers for enhanced stability
- Full perimeter, electric toe guard ensures handler safety
- Platform movement controlled by hand-held push button control system
- Reduce worker strain by positioning materials at a comfortable operating height
- Voltage: 115 V
- Frame Material: Steel

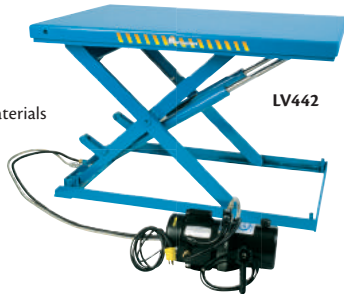

Bishamon

Model No.	Mfg. No.	Motor HP	Lift Vertical Travel"	Height		Platform Dimensions L' x W"	Capacity lbs.
				Raised	Lowered		
LV442	LX-25S	1/2	18	20.9	2.9	32-1/2 x 23-1/2	550
LV443	LX-25L	1/2	27.1	30	2.9	40 x 23-1/2	550
LV444	LX-50S	1/2	18	20.9	2.9	32.5 x 23-1/2	1100
LV445	LX-50L	1/2	27.1	30	2.9	40 x 23-1/2	1100
LV446	LX-100W	1	35.3	38.6	3.3	51 x 34-1/2	2200
LV447	LX-100N	1	35.3	38.6	3.3	51 x 24	2200

OPTIMUS® ELECTRIC-HYDRAULIC SCISSOR LIFT TABLE

- Intelligent design with rounded platform corners
- Unitized power unit with easy-view hydraulic reservoir
- Hinged maintenance bars are powder-coated for improved safety
- Voltage: 115 V
- Current: AC
- Frame Material: Steel



Bishamon

Model No.	Mfg. No.	Lift Vertical Travel"	Height		Platform Dimensions L' x W"	Capacity lbs.
			Raised"	Lowered"		
LV450	L2K-2848	30	38.5	8.5	48 x 28	2000
LV451	L2K-3648	30	38.5	8.5	48 x 36	2000
LV452	L2K-TT	30	41.5	11.5	43 x 43	2000
LV453	L3K-2848	34	42.6	8.6	48 x 28	3000
LV454	L3K-3648	34	42.6	8.6	48 x 36	3000
LV455	L3K-TT	34	45.8	11.8	43 x 43	3000

PLATFORM TILTER

- Designed to position containers within easy reach of machine operators
- Reduces fatigue by minimizing repetitive bending and stretching required to obtain components
- Platform includes a 12" high lip on tilt side
- Uses 2HP, three phase, 60 Hz totally enclosed motor
- Operation Type: Hydraulic
- Other features include: two-button handheld control, integrated maintenance lock, pressure compensated flow valve and adjustable upward travel limit switch
- CSA Compliant

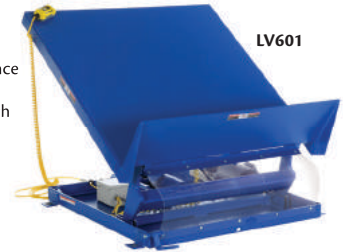

Vestil
www.vestil.com

Model No.	Mfg. No.	Height		Platform Dimensions L' x W"	Capacity lbs.
		Raised"	Lowered"		
LV601	UNI-2448-4	42-1/4	8	48 x 24	4000
LV602	UNI-3648-2	42-1/4	8	48 x 36	2000
LV604	UNI-3648-4	42-1/4	8	48 x 36	4000
LV606	UNI-4848-2	42-1/4	8	48 x 48	2000
LV608	UNI-4848-4	42-1/4	8	48 x 48	4000
LV611	UNI-4848-6	42-1/4	8	48 x 48	6000
LV612	UNI-5448-4	42-1/4	8	48 x 54	4000
LV613	UNI-5448-6	42-1/4	8	48 x 54	6000

NARROW MAST POWERED LIFT STACKER

- Powered lift can raise and lower loads quickly and easily
- Narrow mast design provides improved manoeuvrability and efficiency
- Uses 12V battery, with integral battery charger and battery level gauge
- Equipped with support legs
- Operation Type: Electric



Vestil
www.vestil.com

Model No.	Mfg. No.	Height		Lifting Capacity lbs.	
		Raised"	Lowered"	@ 63"	@ 118"
ADJUSTABLE FORKS					
LV585	SLNM-118-AA	118	2	1500	1000
LV587	SLNM15-63-AA	63	2	1500	-
FIXED FORKS					
LV586	SLNM-118-FF	118	3.25	1500	1000
LV588	SLNM15-63-FF	63	3.25	1500	-

SEMI-ELECTRIC FORK LIFT STACKER

- Powered lift can raise and lower loads quickly and easily
- Manual push stackers are easily manoeuvrable using pull handle
- Uses 12V, 130-140A battery, with integral battery charger and battery level gauge
- Equipped with support legs
- Optional 24V traction drive system available upon request



Vestil
www.vestil.com

Model No.	Mfg. No.	Height		Lifting Capacity lbs.		
		Raised"	Lowered"	@ 63"	@ 118"	@ 150"
ADJUSTABLE FORKS						
LV582	SL-150-AA	150	2.125	2000	1500	1000
LV583	SL-63-AA	63	2.125	2000	-	-
FIXED FORKS						
LV580	SL-118-FF	118	3.375	2000	1500	-
LV584	SL-63-FF	63	3.375	2000	-	-

HYDRAULIC PLATFORM LIFT STACKER

- Allow workers to maneuver and lift heavy loads safely to comfortable needed height
- Foot pedal folds safely out of the way
- Front 5" polyurethane casters and rear 3" polyurethane wheels allow loads to move easily



KLETON

SPECIFICATIONS:

Capacity: 880 lbs.
 Overall dimensions: 22 1/2" W x 39" D x 67 3/4" H
 Platform dimensions: 25 3/4" L x 22 3/4" W
 Lowered platform height: 4"
 Raised platform height: 60"
 Weight: 174 lbs.

Model No. MN397

HYDRAULIC PLATFORM LIFT STACKER

- Allows workers to maneuver and lift heavy loads safely to comfortable needed height
- Front 5" and rear 4" phenolic casters allow loads to be moved easily
- Stacker comes standard with floor locks, safety screen and foot guards for safety



WESCO

SPECIFICATIONS:

Capacity: 1000 lbs. at 15" load center
 Overall dimensions: 25.5" W x 40" D x 80" H
 Platform size: 24" x 24"
 Lowered platform height: 5 3/4"
 Raised platform height: 68"
 Base legs: 15" inner, 21" outer
 Wheels: 5" front, 4" rear
 Weight: 234 lbs.

Model No. MH690

PLATFORM LIFT STACKERS

HAND WINCH

- Ideal for office use and narrow aisles
- Lightweight and sturdy design

ELECTRIC

- Sealed battery and automatic charger built in
- Remote up and down pendant for electric model



WESCO

Model No.	Mfg. No.	Operation Type	Platform Height Raised"	Platform Height Lowered"	Platform Dimensions W" x D"	Lifting Capacity lbs.
LU510	272467	Hand Winch	66	5	18 x 23	220
LU543	272468	Electric	66	5	18 x 23	220

HYDRAULIC FORK LIFT STACKER

- Adjustable 4" wide x 25.5" long forks
- Adjustable fork width 8.5" to 19.5"
- Two 5" polyurethane swivel casters with brake and two 3" polyurethane rigid load wheels
- Chrome plated rails and handle
- Lifting Capacity: 880 lbs.
- Operation Type: Foot Pump
- Shipped knocked down



WESCO

Model No.	Mfg. No.	Height Raised"	Height Lowered"
LU511	272941	59	3.5
LU549	272940	47	3.5

PLATFORM LIFT STACKERS

- Lift and transport loads at ease
- The platform lifts approximately 1" per winch rotation or foot pump stroke
- Rolls smoothly on 6" x 2" poly-on-poly rear wheels with 2" semi-steel front wheels
- **LV481:** Rolls smoothly on 8" x 2" poly-on-poly rear wheels, four swivel casters, and a hand operated floor lock



LU507



LV480

Vestil
We've Got It!

Model No.	Mfg. No.	Operation Type	Platform Height		Platform Dimensions W" x D"	Lifting Capacity lbs.
STEEL						
LU506	LLW-202058-FW	Hand Winch	3-1/8	58	20 x 20	500
LU507	LLH-202053-FW	Foot Pump	3-1/8	51-1/8	20 x 20	500
ALUMINUM						
LV480	ALLW-2020-FW	Hand Winch	3-1/8	58	20 x 20	400
LV481	ALLW-2420-45FL	Hand Winch	6-1/8	60	24 x 20	400

FORK LIFT STACKERS

- Compact lift trucks are designed to lift material to and from shelves
- Constructed of durable steel-and-aluminum
- The rugged 4" wide by 1." thick steel forks measure 22" long (20." O.D.)
- Hand-crank winch features a reversible handle and a hold-down device for securing the carriage during transport
- Operation Type: Hand Winch
- Two 8" non-marking rear wheels, two 2" front swivel casters
- **LU503-LU505:** Counter balanced design has poly-on-poly wheels, (2) 5" rear wheels, (2) 4" front wheels.



Vestil
We've Got It!

Model No.	Mfg. No.	Height		Height w/Forks Up		Overall Dimensions			Lifting Capacity lbs.		
STANDARD											
LU498	A-LIFT-R	47	3.5	67	23.5	24	x	35	x	68-3/4	500
LU499	A-LIFT-R-HP	97	3.5	117	23.5	24	x	35	x	67-5/16	400
STRADDLE											
LU500	A-LIFT-S	47	1.25	68	21.25	43-7/8	x	42-1/2	x	67-5/16	500
LU501	A-LIFT-S-HP	98	1.25	120	21.25	43-7/8	x	42-1/2	x	67-5/16	400
LU502	A-LIFT-S-EHP	122	1.25	143	21.25	43-7/8	x	42-1/2	x	79-1/8	350
COUNTERBALANCE											
LU503	A-LIFT-CB	47	2	68	21.25	43-1/4	x	45-7/8	x	67-15/16	500
LU504	A-LIFT-CB-HP	98	2	120	21.25	43-1/4	x	45-7/8	x	67-15/16	400
LU505	A-LIFT-CB-EHP	122	2	143	21.25	43-1/4	x	46	x	79-1/8	350

LIFTING, POSITIONING & STACKING

F.O.B. VAUDREUIL, QC. ITEMS ON THIS PAGE ARE MADE TO ORDER AND ARE NON-RETURNABLE

ADJUSTABLE GANTRY CRANES

- Adjustable gantry cranes move and lift heavy equipment with ease
- Height adjustable between 8' and 14'
- Equipped with four heavy-duty steel swivel casters with wheel brakes
- H-Beams use flat-wheel trolleys; I-Beams use taper-wheel trolleys.
- Can be fitted with or without casters
- Shipped knocked down

MuscleMate



Model No.	O.A. Span A'	Clear Span B	Hook Lift Min/Max C	O.A. Height Min/Max D	Beam Height E"	Wheel Spread Min/Max F	Unit Beam Width"	Lifting Cap. lbs.	Wt. lbs.
LA189	10	47"	6'8"/11'6"	8'9"/14'7"	6	4'7"/7'	3 3/8	2000	885
LA190	15	97"	6'6"/11'10"	8'9"/14'7"	8	4'7"/7'	5 1/4	2000	1050
LA191	10	47"	6'2"/11'10"	8'9"/14'7"	8	4'7"/7'	4	4000	1175
LA192	15	97"	6'/11'8"	8'9"/14'7"	10	4'7"/7'	5 3/4	4000	1370
LA193	10	47"	5'/11'1"	8'9"/14'9"	10	4'10"/7'3"	4 5/8	6000	1430
LA194	15	97"	5'/11'1"	8'9"/14'9"	10	4'10"/7'3"	5 3/4	6000	1615

Note: Crane only, hoist and trolley not included.

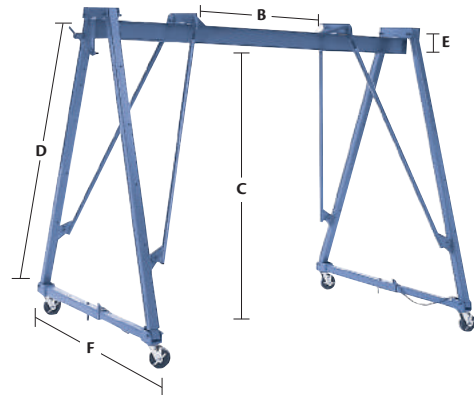

SPREADER BEAM

- Comes standard with lifting shackles
- Custom lengths and capacities available

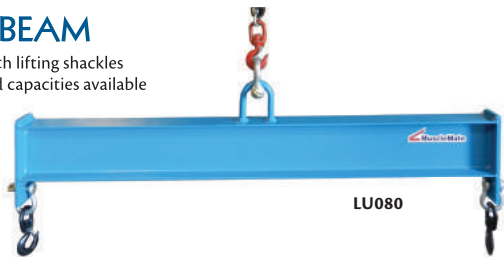

LU080



LU096

MuscleMate

Model No.	Spreader Type	Dimensions to Hook'	Capacity lbs. (tons)
LU080	Fixed	4	1000 (0.5)
LU081	Fixed	6	1000 (0.5)
LU082	Fixed	8	1000 (0.5)
LU083	Fixed	10	1000 (0.5)
LU084	Fixed	4	2000 (1)
LU085	Fixed	6	2000 (1)
LU086	Fixed	8	2000 (1)
LU087	Fixed	10	2000 (1)
LU088	Fixed	4	4000 (2)
LU089	Fixed	6	4000 (2)
LU090	Fixed	8	4000 (2)
LU091	Fixed	10	4000 (2)
LU092	Fixed	4	10 000 (5)
LU093	Fixed	6	10 000 (5)
LU092	Fixed	8	10 000 (5)
LU093	Fixed	10	10 000 (5)

Model No.	Spreader Type	Hook to Hook			Capacity lbs. (tons)
		Min	-	Max	
LU096	Adjustable	3.5'	-	6'	1000 (0.5)
LU097	Adjustable	4'	-	8'	1000 (0.5)
LU098	Adjustable	5'	-	10'	1000 (0.5)
LU099	Adjustable	6'	-	12'	1000 (0.5)
LU101	Adjustable	4'	-	8'	2000 (1)
LU102	Adjustable	5'	-	10'	2000 (1)
LU103	Adjustable	6'	-	12'	2000 (1)
LU104	Adjustable	3.5'	-	6'	4000 (2)
LU105	Adjustable	4'	-	8'	4000 (2)
LU106	Adjustable	5'	-	10'	4000 (2)
LU107	Adjustable	6'	-	12'	4000 (2)
LU108	Adjustable	4'	-	8'	10 000 (5)
LU109	Adjustable	5'	-	10'	10 000 (5)
LU110	Adjustable	6'	-	12'	10 000 (5)

LIFT MATE WORKSTATION GANTRIES

- Equip your assembly area with an effective working concept
- Equipped with steel floor pads, pre-drilled for anchoring to floor
- To customize unit, additional options include chain blocks, festoon kit, trolley, 10' L beam for cantilever operation
- Adjustable height
- Heavy capacities and "A" frame styles are available upon request
- Shipped knocked down

Model No. LT481 Capacity: 1000 lbs.
Model No. LT482 Capacity: 2000 lbs.



MuscleMate



LIFTING, POSITIONING & STACKING

F.O.B. VAUDREUIL, QC. ITEMS ON THIS PAGE ARE MADE TO ORDER AND ARE NON-RETURNABLE

WALL JIBS

STYLE 100 & 200

- Mount at any height on a wall, column or building support
- Wall mounting gives 180° rotation, column mounting provides 220° of rotation
- Equipped with end stops to limit trolley travel
- **H-Beams** use flat-wheel trolleys; **I-Beams** use taper-wheel trolleys

STYLE 100

Cantilever design is ideally suited for mounting applications where headroom is limited.

STYLE 200

Easily adjustable tie rod jibs are designed to mount within inches of any overhead obstruction.

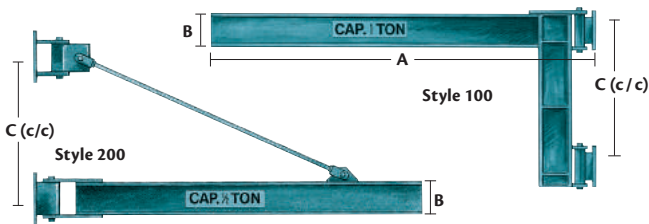

Model No.	Dimensions			Flange Width"	Beam Type	Cap. lbs.	Wt. lbs.
	A'	B"	C"				
STYLE 100							
LA221	8	6	32	3	I	1000	192
LA219	10	8	36	4	I	1000	300
LA220	12	8 1/8	45	5 1/4	H	1000	295
LA224	8	8	32	4	I	2000	265
LA222	10	10	36	4 5/8	I	2000	390
LA223	12	10 3/8	45	5 3/4	H	2000	435
LA779	8	12	36	5	I	4000	450
LA780	10	12	48	5	I	4000	550
LA781	12	12	60	5	I	4000	650
STYLE 200							
LA227	8	6	32	3 3/8	I	1000	163
LA225	10	6	36	3 3/8	I	1000	190
LA226	12	6	45	3 3/8	I	1000	233
LA782	14	8 1/8	54	5 1/4	H	1000	340
LA783	16	8 1/8	66	5 1/4	H	1000	375
LA230	8	6	32	3 3/8	I	2000	180
LA228	10	6	36	3 3/8	I	2000	220
LA229	12	6	45	3 3/8	I	2000	243
LA784	14	8 1/8	54	5 1/4	H	2000	350
LA785	16	8 1/8	66	5 1/4	H	2000	385
LA786	8	10	36	4 5/8	I	4000	395
LA787	10	10	38	4 5/8	I	4000	445
LA788	12	10	51	4 5/8	I	4000	495
LA789	14	10 3/8	58	5 3/4	H	4000	545
LA790	16	10 3/8	68	5 3/4	H	4000	595

PALLET LIFTERS

- Ideal for use with crane systems or with truck cranes
- Economical pallet lifters are available in four capacities with three adjustable or non-adjustable fork lengths to choose from

A - Throat height (clear) 48"
 B - Fork length 36", 42", or 48"
 C - Widths (O.D.) 27"

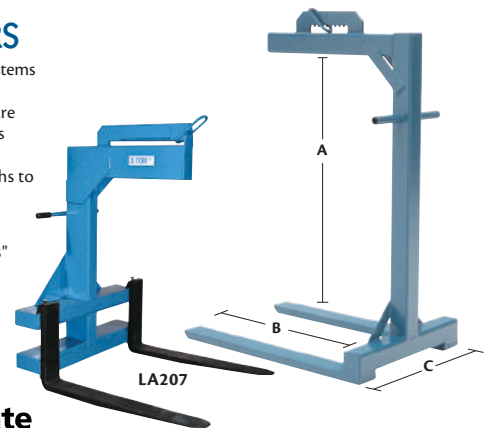

Fork Length"	Cap. lbs.	Standard Model No.	Wt. lbs.	Adj. Model No.	Wt. lbs.
36	1000	LA195	190	LA207	270
42		LA196	230	LA208	295
48		LA197	255	LA209	325
36	2000	LA198	195	LA210	280
42		LA199	233	LA211	305
48		LA200	260	LA212	335
36	4000	LA201	310	LA213	380
42		LA202	337	LA214	430
48		LA203	370	LA215	475
36	6000	LA204	522	LA216	525
42		LA205	560	LA217	560
48		LA206	602	LA218	612

ADJUSTABLE PALLET LIFTERS

- Ideal for use with crane systems or with truck cranes
- Economical pallet lifters are available in four capacities with three adjustable or non-adjustable fork lengths to choose from

A - Throat height (clear): 48"
 B - Fork length: 36", 42", or 48"
 C - Width: (O.D.) 27"



Model No.	Fork Length"	Cap. lbs.	Wt. lbs.
LT475	36	1000	190
LT476	42	1000	230
LT477	48	1000	270
LT478	36	2000	195
LT479	42	2000	235
LT480	48	2000	260

JIB BOOMS

- Instantly converts fork lift trucks into mobile jib cranes for an infinite variety of uses
- Fully adjustable booms reach out, pick-up, and move heavy long loads making your fork lift more versatile
- Boom slips onto the forks and anchors to the truck with a safety chain
- Includes two adjustable hooks



Model No.	Boom Type	Min. Fork Lift Cap. lbs.	Max. Boom Cap. lbs. (Reach ft.)					Wt. lbs.	
			0-7	8	9	10	11		12
LA188	Fixed	3000	1000	800	725	650	600	500	255
LA187	Elevating	3000							285
LA186	Fixed	8000	3000	2700	2400	2200	2000	1900	438
LA185	Elevating	8000							483

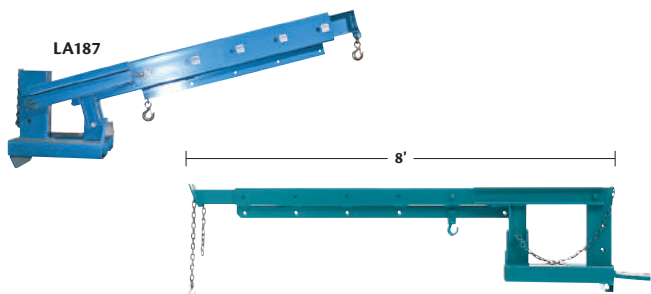

LIFTING, POSITIONING & STACKING

BEAM CLAMP

- Caution: Never exceed work load limit



VANGUARD STEEL LTD.

Model No.	Jaw Opening"	Capacity lbs. (tons)
LU561	0 - 10-1/4	2000 (1)
LU562	0 - 10-1/4	4000 (2)
LU563	0 - 13-15/16	6000 (3)
LU564	0 - 13-15/16	10000 (5)
LU565	0 - 14-3/8	20000 (10)

GX LIFTING CLAMPS

- Entirely drop forged and heat treated
- Strong, yet lightweight
- Ideal for both vertical and horizontal-to-vertical lifting
- Feature a patented wear indicator system
- 100% proof tested



Campbell®

Model No.	Grip Range	Capacity Ton	Wt. lbs.
LB606	1/16" - 5/8"	1/2	4
LB607	1/16" - 3/4"	1	8
LB608	1/16" - 1"	3	17

POWERLIFT® MAGNETS

- Compact yet powerful rare earth lift magnets can be used on flat or round surfaces and contain an internal release on/off device that does not contact or damage the surface of the part being lifted
- Permanent magnetic lifts eliminate the fear of dropping the load being lifted due to power failures
- 3:1 design factor
- **Conforms to ASME B30.20 standards**



MAG-MATE™

Model No.	Minimum Diameter"	Handle"	Dimensions			Capacity lbs.		Wt. lbs.
			L"	W"	H"	Flat	Round	
LS712	2	5 7/8	5	2 5/8	6 5/8	250	125	7
LS713	3	6 7/8	7 7/8	3 5/8	8 7/8	800	400	22
LS714	4	6 3/4	10 3/4	4 7/8	8 7/8	1600	800	53
LS715	5	10 1/8	12 5/8	7 1/8	8 7/8	2500	1250	110

HOLDING VALUE & MAX. SHEET LENGTH (IN FEET) FOR SPECIFIED MATERIAL THICKNESS

Model No.	1/4"		1/2"		3/4"		1"		3"	
	Length	Cap lbs.	Length	Cap lbs.	Length	Cap lbs.	Length	Cap lbs.	Length	Cap lbs.
LS712	6	180	6	250	6	250	10	250	10	250
LS713	6	270	6	615	6	800	10	800	10	800
LS714	-	N/A	6	800	6	1600	10	1600	10	1600
LS715	-	N/A	-	N/A	-	N/A	10	1300	10	2500

CHAIN HOISTS

- Lightweight steel construction
- Triple spur geared for easy lifting
- Load brake assures safety and load control
- High tensile alloy steel load chain for increased strength and durability
- Latched swivel hooks for added security
- Enclosed chain guide ensures dirt and dust do not affect operation



KLETON

Model No.	Lift'	Cap. lbs.	Wt. lbs.
LS534	10	1000	24
LS535	10	2000	29
LS536	10	3000	44
LS537	10	4000	48
LS538	10	6000	59
LS539	10	10000	100
LS540	20	1000	36
LS541	20	2000	40
LS542	20	3000	59
LS543	20	4000	62
LS544	20	6000	84
LS545	20	10000	136

LEVER HOISTS

- Lightweight steel construction
- Short steel handle rotates 360° to allow operation in any position
- Load brake assures safety and load control
- High tensile alloy steel load chain for increased strength and durability
- Latched swivel hooks for added security
- Enclosed chain guide ensures dirt and dust do not affect operation



KLETON

Model No.	Lift'	Cap. lbs.	Wt. lbs.
LS546	5	1500	15
LS547	5	2000	18
LS548	5	3000	24
LS549	5	6000	42
LS550	5	12000	62

ADJUSTABLE TROLLEYS

- Easily adjusts to fit various flange and I-beams
- Use on straight or curved track
- Can be installed or removed at any position on the beam
- Heavy-duty cast iron wheels
- Deep width flange provides superior contact with the beam
- Geared trolleys include two geared wheels operated by hand chain
- Safety plate included



Adjustable Plain Trolley

KLETON



Model No.	Fits I beams"	Cap. lbs.	Wt. lbs.
PLAIN			
LS551	2 11/16 - 5 3/8	1000	10
LS552	3 1/8 - 6 1/4	2000	17
LS553	3 1/8 - 6 1/4	4000	28
LS554	3 7/16 - 7 3/8	6000	46
LS555	4 13/16 - 9 9/16	10000	73

Model No.	Fits I beams"	Cap. lbs.	Wt. lbs.
GEARED			
LS556	2 11/16 - 5 1/4	1000	18
LS557	3 1/8 - 5 15/16	2000	25
LS558	3 1/8 - 7 1/16	4000	36
LS559	3 7/16 - 7 3/8	6000	54
LS560	4 3/4 - 7 3/4	10000	81



Adjustable Geared Trolley

GALVANIZED AIRCRAFT CABLES

Dia.™	Breaking Strength lbs.		Model No.	Feet Per Pkg.	Model No.	Feet Per Pkg.	
3/64	270		LA893	100	LB030	500	
1/16	480		LA894	100	LB031	500	
5/64	650		LA895	100	LB032	500	
3/32	920		LA896	100	LB033	500	
1/8	1700		LA897	100	LB034	500	
5/32	2600		LA898	100	LB035	500	
3/16	3700		LA899	100	LB036	500	
1/4	6100		LA900	100	LB037	500	
3/32	1000			LA902	100	LB039	500
1/8	2000			LA903	100	LB040	500
5/32	2800	LA904		100	LB041	500	
3/16	4200	LA905		100	LB042	500	
1/4	7000	LA906		100	LB043	500	
5/16	9800	LA907		100	LB044	500	
3/8	14400	LA908		100	LB045	500	
1/2	20700	LA909		100	LB046	500	

Special sizes available on request

COATED GALVANIZED CABLE (PVC)

Outside Dia.™	Inside Dia.™	Construction	Colour	Model No.	Feet Per Pkg.	Model No.	Feet Per Pkg.
3/16	1/8	7 x 19	Clear	LA910	100	LB289	500
3/16	1/8	7 x 19	Red	LA911	100	LB290	500

Special sizes available on request

EYE BOLTS

Model No.	Dia. & Take-up™	Working Load Limit lbs.
REGULAR NUT EYE BOLTS (Galvanized, Drop-Forged)		
LA974	5/16 x 4 1/4	800
LA975	3/8 x 2 1/2	1200
LA976	3/8 x 4 1/2	1200
LA977	1/2 x 8	2200
LA978	1/2 x 10	2200
LA979	5/8 x 4	3500
LA980	5/8 x 12	3500
SHOULDER NUT EYE BOLT (Galvanized, Drop-Forged)		
LA981	3/8 x 2 1/2	1200
SHOULDER TYPE MACHINERY EYE BOLTS (Steel)		
LU482	3/8 x 1 1/4	1300
LU483	1/2 x 1 1/2	2400
LU484	5/8 x 1 3/4	4000



THIMBLES

Model No.	For Cable Dia.™	Type
LA933	3/64 - 1/16 - 5/64	AN
LA934	3/32 - 7/64 - 1/8	AN
LA935	5/32	AN
LA936	3/16	AN
LA939	1/4	AN
LA940	5/16	STD
LA941	3/8	STD
LA942	1/2	STD
LA943	5/8	STD
LA944	3/4	STD
LA945	1	HD

Type: AN - Zinc-Plated, STD - Galvanized Standard, HD - Hot Deep Galvanized



WIRE ROPE CLIPS

Model No.	For Cable Dia.™	Model No.	For Cable Dia.™
MALLEABLE ZINC-PLATED			
LB007	1/8		
LB008	3/16		
LB009	1/4		
LB010	5/16		
LB011	3/8		
LB012	1/2		
LB013	5/8		
LB014	3/4		
LB015	7/8		
DROP-FORGED GALVANIZED			
LB016	1/8		
LB017	3/16		
LB018	1/4		
LB019	5/16		
LB020	3/8		
LB021	1/2		
LB022	5/8		
LB023	3/4		



TURNBUCKLES

Eye & Eye Model No.	Jaw & Jaw Model No.	Diameter Take-Up™	Working Load Limit lbs.		Wt. lbs.
			E & E	J & J	
LA947	MMS321	5/16 x 4 1/2	800	700	0.45
LA948	MMS322	3/8 x 6	1200	1000	0.75
LA949	MMS323	1/2 x 6	2200	1500	1.5
LA950	MMS324	1/2 x 9	2200	1500	1.75
LA951	MMS325	1/2 x 12	2200	1500	2.18
LA952	MMS326	5/8 x 6	3500	2250	2.63
LA953	MMS327	5/8 x 9	3500	2250	3
LA954	MMS328	5/8 x 12	3500	2250	3.25
LA955	MMS329	3/4 x 6	5200	3000	3.75
LA956	MMS330	3/4 x 9	5200	3000	4.5
LA957	MMS331	3/4 x 12	5200	3000	5.75
LA958	MMS332	7/8 x 12	7200	4000	8.35
LA959	MMS333	1 x 6	10000	5000	9.04
LA960	MMS334	1 1/2 x 12	21400	7500	27

CARBINE SNAP HOOKS (STAINLESS STEEL 316)

Model No.	Size™	Length™	Eye™	Working Load Limit lbs.
LU970	3/16	2	5/16	120
LU971	1/4	2 3/8	3/8	160
LU972	5/16	3 3/16	1/2	300
LU973	3/8	3 15/16	5/8	400



QUICK LINKS (ZINC-PLATED)

Model No.	Size™	Working Load Limit lbs.
LB001	1/8	220
LB002	3/16	660
LB003	1/4	880
LB004	5/16	1760
LB005	3/8	2140
LB006	1/2	3300



ALUMINUM OVAL SLEEVES

Model No.	For Cable Dia.™	Model No.	For Cable Dia.™
LA912	1/32	LA919	3/16
LA913	3/64	LA920	1/4
LA914	1/16	LA921	5/16
LA915	5/64	LA922	3/8
LA916	3/32	LA923	7/16
LA917	1/8	LA924	1/2
LA918	5/32		

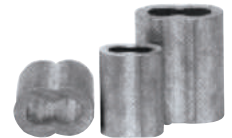

ALUMINUM STOP SLEEVES

Model No.	For Cable Dia.™	Model No.	For Cable Dia.™
LA925	1/16	LA929	3/16
LA926	3/32	LA930	1/4
LA927	1/8	LA931	5/16
LA928	5/32	LA932	3/8



WIRE ROPE LIFTING SLING

EYE & EYE GALVANIZED

- Made of 6x26 IWRC EIPS galvanized wire rope
- Solid identification tags on each sling

Model No.	Wire Diameter™	Length™	Vertical Capacity lbs.
LV024	1/4	4	1300
LV025	1/4	6	1300
LV026	1/4	8	1300
LV027	1/4	10	1300
LV028	1/4	12	1300
LV029	3/8	4	2800
LV030	3/8	6	2800
LV031	3/8	8	2800
LV032	3/8	10	2800
LV033	3/8	12	2800



SLINGS

NYLON SLINGS

- Used in conjunction with overhead cranes, hoists or winches
- Nylon slings are available in single or double ply to protect heavy, irregular sized loads from scratching or marring
- Slings must be checked frequently
- Should any surface area show signs of wear or cutting, the sling must be replaced immediately
- Each is tagged with manufacturer's name and capacity



DOUBLE EYE SLING TYPE 3

- Commonly used as a basket and/or choker hitch
- For choker hitch pass one eye through the other flat eye, also makes for easy withdrawal from beneath loads



TWISTED EYE SLING TYPE 4

- Reverse eyes make full functional contact with lifting hooks without the use of hardware
- Widely used for both choker and basket hitches



ENDLESS SLING TYPE 5

- Most versatile and widely used sling
- The economical answer to most lifting problems
- Ideal for vertical, choker, and basket hitches

LOAD LIMIT FOR TYPE 3-4 (LBS.)

Width"	Vertical		Choker		Basket	
	Single	Double	Single	Double	Single	Double
1	1600	3200	1280	2400	3200	6400
2	3100	6200	2480	4960	6200	12400
3	4700	8800	3760	7040	9400	17600
4	6200	11000	4960	8800	12400	22000

LOAD LIMIT FOR TYPE 5 (LBS.)

Width"	Vertical		Choker		Basket	
	Single	Double	Single	Double	Single	Double
1	3200	6200	2560	4960	6400	12400
2	6200	12400	4960	9930	12400	24800
3	9400	17600	7520	14080	18800	35200
4	12400	22000	9920	17600	24800	44000

Type	Width"	Ply	3' Model No.	4' Model No.	6' Model No.	8' Model No.	10' Model No.	12' Model No.	
Type 3	1	Single	LU292	LU293	LU294	LU295	LU296	LU297	
		Double	LU316	LU317	LU318	LU319	LU320	LU321	
	2	Single	LU298	LU299	LU300	LU301	LU302	LU303	
		Double	LU322	LU323	LU324	LU325	LU326	LU327	
	3	Single	LU304	LU305	LU306	LU307	LU308	LU309	
		Double	LU328	LU329	LU330	LU331	LU332	LU333	
	4	Single	LU310	LU311	LU312	LU313	LU314	LU315	
		Double	LU334	LU335	LU336	LU337	LU338	LU339	
Type 4	1	Single	LU340	LU341	LU342	LU343	LU344	LU345	
		Double	LU364	LU365	LU366	LU367	LU368	LU369	
	2	Single	LU346	LU347	LU348	LU349	LU350	LU351	
		Double	LU370	LU371	LU372	LU373	LU374	LU375	
	3	Single	LU352	LU353	LU354	LU355	LU356	LU357	
		Double	LU376	LU377	LU378	LU379	LU380	LU381	
	4	Single	LU358	LU359	LU360	LU361	LU362	LU363	
		Double	LU382	LU383	LU384	LU385	LU386	LU387	
	Type 5	1	Single	LU388	LU389	LU390	LU391	LU392	LU393
			Double	LU412	LU413	LU414	LU415	LU416	LU417
		2	Single	LU394	LU395	LU396	LU397	LU398	LU399
			Double	LU418	LU419	LU420	LU421	LU422	LU423
3		Single	LU400	LU401	LU402	LU403	LU404	LU405	
		Double	LU424	LU425	LU426	LU427	LU428	LU429	
4		Single	LU406	LU407	LU408	LU409	LU410	LU411	
		Double	LU430	LU431	LU432	LU433	LU434	LU435	

Note: Other sizes, capacities and options available

POLYESTER ROUND SLINGS

- Constructed from multiple high tenacity polyester yarns in an endless/continuous loop
- Excellent resistance to ultra-violet light, rotting and mildew
- The high flexibility allows the sling to conform to the load for a secure hold
- No loss of strength when used in water
- Lightweight, easy to rig, store and clean
- Hook and load contact points can be rotated to extend the service life
- Seamless cover, no edges to wear out
- Maximum temperature exposure: 194°F



Model No.	Width'	Length'	Colour	Capacity lbs.		
				Vertical	Choker	90° Basket
LT569	2	4	Purple	3000	2400	6000
LT570	2	6	Purple	3000	2400	6000
LT571	2	8	Purple	3000	2400	6000
LT572	2	4	Green	6000	4800	12000
LT573	2	6	Green	6000	4800	12000
LT574	2	8	Green	6000	4800	12000
LT575	2	6	Yellow	9000	7200	18000
LT576	2	8	Yellow	9000	7200	18000

Model No.	Width'	Length'	Colour	Capacity lbs.		
				Vertical	Choker	90° Basket
LT577	2	10	Yellow	9000	7200	18000
LT578	3	6	Red	14000	11200	28000
LT579	3	8	Red	14000	11200	28000
LT580	3	10	Red	14000	11200	28000
LT581	4	8	Blue	23000	18400	46000
LT582	4	10	Blue	23000	18400	46000
LT583	4	12	Blue	23000	18400	46000

Note: Other lengths available upon request

POLYESTER SLINGS

- Mainly used outdoors and can withstand increases in temperature and direct sunlight (i.e. improved UV degradation resistance)
- Used in conjunction with overhead cranes, hoists or winches
- Polyester slings are available in single or double ply to protect heavy, irregular sized loads from scratching or marring
- Slings must be checked frequently
- Should any surface area show signs of wear or cutting, the sling must be replaced immediately
- Each is tagged with manufacturer's name and capacity

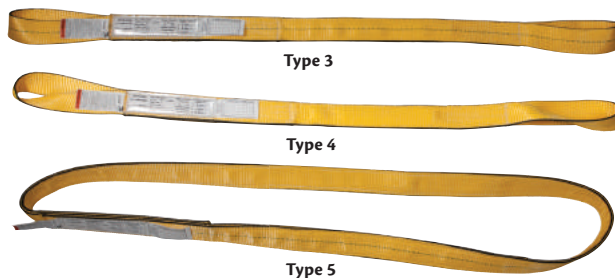

DOUBLE EYE SLING TYPE 3

Commonly used as a basket and/or choker hitch or for choker hitch pass one eye through the other flat eye, also makes for easy withdrawal from beneath loads

TWISTED EYE SLING TYPE 4

Reverse eyes make full functional contact with lifting hooks without the use of hardware. Widely used for both choker and basket hitches

ENDLESS SLING TYPE 5

Most versatile and widely used sling. The economical answer to most lifting problems. Ideal for vertical, choker and basket hitches

LOAD LIMIT FOR TYPE 3-4 (LBS.)

Width"	Vertical		Choker		Basket	
	Single	Double	Single	Double	Single	Double
1	1600	3200	1280	2400	3200	6400
2	3100	6200	2480	4960	6200	12400
3	4700	8800	3760	7040	9400	17600
4	6200	11000	4960	8800	12400	22000

LOAD LIMIT FOR TYPE 5 (LBS.)

Width"	Vertical		Choker		Basket	
	Single	Double	Single	Double	Single	Double
1	3200	6200	2560	4960	6400	12400
2	6200	12400	4960	9930	12400	24800
3	9400	17600	7520	14080	18800	35200
4	12400	22000	9920	17600	24800	44000

Type	Width"	Ply	3' Model No.	4' Model No.	6' Model No.	8' Model No.	10' Model No.	12' Model No.	
TYPE 3	1	Single	LU116	LU117	LU118	LU119	LU120	LU121	
		Double	LU140	LU141	LU142	LU143	LU144	LU145	
	2	Single	LU122	LU123	LU124	LU125	LU126	LU127	
		Double	LU146	LU147	LU148	LU149	LU150	LU151	
	3	Single	LU128	LU129	LU130	LU131	LU132	LU133	
		Double	LU152	LU153	LU154	LU155	LU156	LU157	
	4	Single	LU134	LU135	LU136	LU137	LU138	LU139	
		Double	LU158	LU159	LU160	LU161	LU162	LU163	
TYPE 4	1	Single	LU164	LU165	LU166	LU167	LU168	LU169	
		Double	LU188	LU189	LU190	LU191	LU192	LU193	
	2	Single	LU170	LU171	LU172	LU173	LU174	LU175	
		Double	LU194	LU195	LU196	LU197	LU198	LU199	
	3	Single	LU176	LU177	LU178	LU179	LU180	LU181	
		Double	LU200	LU201	LU202	LU203	LU204	LU205	
	4	Single	LU182	LU183	LU184	LU185	LU186	LU187	
		Double	LU206	LU207	LU208	LU209	LU210	LU211	
	TYPE 5	1	Single	LU212	LU213	LU214	LU215	LU216	LU217
			Double	LU236	LU237	LU238	LU239	LU240	LU241
		2	Single	LU218	LU219	LU220	LU221	LU222	LU223
			Double	LU242	LU243	LU244	LU245	LU246	LU247
3		Single	LU224	LU225	LU226	LU227	LU228	LU229	
		Double	LU248	LU249	LU250	LU251	LU252	LU253	
4		Single	LU230	LU231	LU232	LU233	LU234	LU235	
		Double	LU254	LU255	LU256	LU257	LU258	LU259	

CHAIN SLINGS

- Quality grade 80 alloy steel assembled, feature a design factor of 4:1
- Proof tested and certified to twice the working load limit
- Proof test certificate issued with each sling
- Available with sling hook or grab hook
- Three and four leg assemblies are available upon request
- Slings comes with identification tag indicating size, description and working load limit

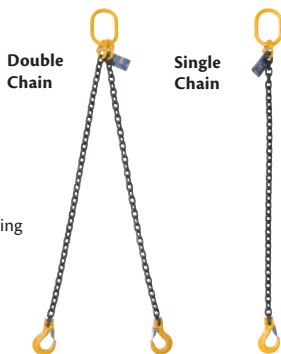

Sling Hook



Grab hook



Chain Size"	Hook Type	5' Sling Model No.	8' Sling Model No.	10' Sling Model No.
SINGLE CHAIN				
9/32	Sling	LT521	LT529	LT537
9/32	Grab	LT522	LT530	LT538
3/8	Sling	LT523	LT531	LT539
3/8	Grab	LT524	LT532	LT540
1/2	Sling	LT525	LT533	LT541
1/2	Grab	LT526	LT534	LT542
5/8	Sling	LT527	LT535	LT543
5/8	Grab	LT528	LT536	LT544

Chain Size"	Hook Type	5' Sling Model No.	8' Sling Model No.	10' Sling Model No.
DOUBLE CHAIN				
9/32	Sling	LT545	LT553	LT561
9/32	Grab	LT546	LT554	LT562
3/8	Sling	LT547	LT555	LT563
3/8	Grab	LT548	LT556	LT564
1/2	Sling	LT549	LT557	LT565
1/2	Grab	LT550	LT558	LT566
5/8	Sling	LT551	LT559	LT567
5/8	Grab	LT552	LT560	LT568

Note: Other lengths, hook types and chain types available upon request

CAPACITY LBS.

Chain Size"	Single	Double		
	90°	60°	45°	30°
9/32	3500	6100	4900	3500
3/8	7100	12300	10000	7100
1/2	12000	20800	17000	12000
5/8	18100	31300	25600	18100

CHAINS

STRAIGHT LINK CHAINS

GRADE 30

- Design factor 4:1
- 100% welded chain
- Material: Low Carbon Steel
- Grade 30 chain must not be used for overhead lifting
- Sold and priced per drum



LU925 - Self-Coloured



LU928 - Hot-Dip Galvanized



LU935 - Zinc Plated



Model No.	Chain Length	Trade Size"	Finish	Working Load Limit lbs. (tons)
LU919	1000' (304.8 m)	1/8	Self-Coloured	400 (0.2)
LU920	750' (228.6 m)	3/16	Self-Coloured	800 (0.4)
LU921	350' (106.7 m)	1/4	Self-Coloured	1300 (0.65)
LU922	250' (76.2 m)	5/16	Self-Coloured	1900 (0.95)
LU923	175' (53.3 m)	3/8	Self-Coloured	2650 (1.325)
LU924	100' (3.05 m)	1/2	Self-Coloured	4500 (2.25)
LU925	100' (3.05 m)	3/4	Self-Coloured	10600 (5.3)
LU926	1000' (304.8 m)	1/8	Hot-Dip Galvanized	400 (0.2)
LU927	750' (228.6 m)	3/16	Hot-Dip Galvanized	800 (0.4)
LU928	350' (106.7 m)	1/4	Hot-Dip Galvanized	1300 (0.65)
LU929	250' (76.2 m)	5/16	Hot-Dip Galvanized	1900 (0.95)
LU930	175' (53.3 m)	3/8	Hot-Dip Galvanized	2650 (1.325)
LU931	100' (3.05 m)	1/2	Hot-Dip Galvanized	4500 (2.25)
LU932	150' (45.7 m)	5/8	Hot-Dip Galvanized	6900 (3.45)
LU933	100' (3.05 m)	3/4	Hot-Dip Galvanized	10600 (5.3)
LU934	100' (3.05 m)	1	Hot-Dip Galvanized	17900 (8.95)
LU935	1000' (304.8 m)	1/8	Zinc Plated	400 (0.2)
LU936	750' (228.6 m)	3/16	Zinc Plated	800 (0.4)
LU937	350' (106.7 m)	1/4	Zinc Plated	1300 (0.65)
LU938	250' (76.2 m)	5/16	Zinc Plated	1900 (0.95)
LU939	175' (53.3 m)	3/8	Zinc Plated	2650 (1.325)
LU940*	350' (106.7 m)	1/8	Zinc Plated	400 (0.2)
LU941*	250' (76.2 m)	3/16	Zinc Plated	800 (0.4)
LU942*	140' (42.7 m)	1/4	Zinc Plated	1300 (0.65)
LU943*	90' (27.4 m)	5/16	Zinc Plated	1900 (0.95)
LU944*	63' (19.2 m)	3/8	Zinc Plated	2650 (1.325)

* Sold and priced per pair

GRADE 70 TRANSPORT CHAIN

- Commonly used as a binder tie down chain, meeting the stringent Department of Transportation requirements
- Permanently embossed with L7 or V7 every 6 links
- 100% Welded chain
- Must not be used for overhead lifting
- Chain Grade: Grade 70
- Material: Heat-Treated Carbon Steel
- Finish: Gold Chromate Plated
- **Sold and priced per foot, minimum 25' chain length is required**



LV373

Model No.	Trade Size"	Working Load Limit lbs. (tons)
IMPORTED		
LV373	1/4	3150 (1.57)
LV374	5/16	4700 (2.35)
LV375	3/8	6600 (3.3)
LV376	1/2	11300 (5.65)
USA MADE		
LV377	1/4	3150 (1.57)
LV378	5/16	4700 (2.35)
LV379	3/8	6600 (3.3)
LV380	1/2	11300 (5.65)

STRAIGHT LINK LIFTING CHAINS

- Design factor 4:1 (in accordance with NACM specifications)
- Produced from the highest quality domestic alloy steel
- Material: Heat-Treated Alloy Steel
- 100% welded chain
- Approved for overhead lifting
- Meets the specifications of NACM, ASTM and O.S.H.A.
- **Sold and priced per foot, minimum 25' chain length is required***

Never exceed WLL, always use Grade 80 or higher chains for overhead lifting

GRADE 80

- Permanently embossed with L8 (grade) and trace code every 6 alternating links
- Black coated finish



LU949

GRADE 100

- Permanently embossed with L10 (grade) and trace code every 6 alternating links
- 25% higher working load limit than comparable Grade 80 alloy chain
- Grey coated finish



LU954



Model No.	Trade Size"	Working Load Limit lbs. (tons)
GRADE 80		
LU945	9/32	3500 (1.75)
LU946	5/16	4500 (2.25)
LU947	3/8	7100 (3.55)
LU948	1/2	12000 (6)
LU949	5/8	18100 (9.05)
LU950	3/4	28300 (14.15)
LU951	7/8	34300 (17.15)
LU952	1	47700 (23.85)
GRADE 100		
LU953	9/32	4300 (2.15)
LU954	3/8	8800 (4.4)
LU955	1/2	15000 (7.5)
LU956	5/8	22600 (11.3)

SCREW PIN ANCHOR SHACKLES

- Heat treated carbon steel bows, quenched and tempered with Alloy pins
- Meets the performance requirements of U.S. Fed. Spec. RR-C-271D, ASME B30.26, Type 4A, Class 2 Grade B



Model No.	Size"	Pin Diameter"	Capacity lbs. (tons)
YELLOW CHROMATE PLATED			
LU729	3/8	7/16	4000 (2)
LU730	7/16	1/2	5300 (2.65)
LU731	1/2	5/8	6600 (3.3)
LU732	5/8	3/4	10000 (5)
LU733	3/4	7/8	14000 (7)
LU734	7/8	1	19000 (9.5)
LU735	1	1-1/8	25000 (12.5)
LU736	1-1/8	1-1/4	30000 (15)
LU737	1-1/4	1-3/8	36000 (18)
LU738	1-1/2	1-5/8	60000 (30)
HOT DIP GALVANIZED			
LU739	3/16	1/4	660 (0.33)
LU740	1/4	5/16	1000 (0.5)
LU741	5/16	3/8	1500 (0.75)
LU742	3/8	7/16	2000 (1)
LU743	7/16	1/2	3000 (1.5)
LU744	1/2	5/8	4000 (2)
LU745	5/8	3/4	6500 (3.25)
LU746	3/4	7/8	9500 (4.75)
LU747	7/8	1	13000 (6.5)
LU748	1	1-1/8	17000 (8.5)
LU749	1-1/8	1-1/4	19000 (9.5)
LU750	1-1/4	1-3/8	24000 (12)
LU751	1-3/8	1-1/2	27000 (13.5)
LU752	1-1/2	1-5/8	34000 (17)
LU753	1-3/4	2	50000 (25)
LU754	2	2-1/4	70000 (35)
LU755	2-1/2	2-3/4	110000 (55)



LU729



LU739

CLEVIS HOOKS

GRADE 40

- For use with Grade 40 or lower chains only
- Self-coloured body with "gold-pin"
- Material: Forged Carbon

Not for use with overhead lifting applications

Model No.	For Chain Diameter Size"	Working Load Limit lbs. (tons)
CLEVIS GRAB HOOK		
LV052	1/4	2600 (1.3)
LV053	5/16	3900 (1.95)
LV054	3/8	5400 (2.7)
LV055	7/16	7200 (3.6)
LV056	1/2"	9200 (4.6)

Model No.	For Chain Diameter Size"	Working Load Limit lbs. (tons)
CLEVIS SLING HOOK		
LV034	1/4	1950 (0.975)
LV035	5/16	2875 (1.43)
LV036	3/8	4000 (2)
LV037	1/2	6000 (3)

GRADE 70

- For use with Grade 70 or lower chains only
- Gold Chromate body with "black-pin"
- Material: Alloy Steel

Not for use with overhead lifting applications

Model No.	For Chain Diameter Size"	Working Load Limit lbs. (tons)
CLEVIS GRAB HOOK		
LV057	1/4	3150 (1575 tons)
LV059	5/16	4700 (2.35)
LV061	3/8	6600 (3.3)
LV063	7/16	8800 (4.4)
LV064	1/2	11300 (5.65)

Model No.	For Chain Diameter Size"	Working Load Limit lbs. (tons)
CLEVIS GRAB HOOK W/LATCH		
LV058	1/4	3150 (1575)
LV060	5/16	4700 (2.35)
LV062	3/8	6600 (3.3)
LV065	1/2	11300 (5.65)

Model No.	For Chain Diameter Size"	Working Load Limit lbs. (tons)
CLEVIS SLING HOOK		
LV038	1/4	2750 (1.375)
LV040	5/16	4300 (2.15)
LV042	3/8	5250 (2.625)
LV044	7/16	7000 (3.5)
LV046	1/2	9000 (4.5)

Model No.	For Chain Diameter Size"	Working Load Limit lbs. (tons)
CLEVIS SLING HOOK W/LATCH		
LV039	1/4	2750 (1.375)
LV041	5/16	4300 (2.15)
LV043	3/8	5250 (2.625)
LV045	7/16	7000 (3.5)
LV047	1/2	9000 (4.5)



GRADE 80 & 100

- Permanently embossed with VDG, size, model number and trace code
- Proof tested to 2.5 times the Working Load Limit (WLL)
- Material: Alloy Steel
- Meets or exceeds ASTM A-952-96 standard
- Meets EN1677 standard (20,000 cycle fatigue test)

GRADE 80

Model No.	For Chain Diameter Size"	Working Load Limit lbs. (tons)
CLEVIS GRAB HOOK		
LU841	5/16	4500 (2.25)
LU842	3/8	7100 (3.55)
LU843	1/2	12,000 (6)
LU844	5/8	18,100 (9.05)
LU845	3/4	28,300 (14.15)
LU846	7/8	34,200 (17.1)

Model No.	For Chain Diameter Size"	Working Load Limit lbs. (tons)
CLEVIS SLING HOOK W/LATCH		
LU847	5/16	4500 (2.25)
LU848	3/8	7100 (3.55)
LU849	1/2	12,000 (6)
LU850	5/8	18,100 (9.05)
LU851	3/4	28,300 (14.15)
LU852	7/8	34,200 lbs. (17.1)

Model No.	For Chain Diameter Size"	Working Load Limit lbs. (tons)
CLEVIS SLING HOOK W/LOCKING LATCH		
LU853	5/16	4500 (2.25)
LU854	3/8	7100 (3.55)
LU855	1/2	12,000 (6)
LU856	5/8	18,100 (9.05)
LU857	3/4	28,300 (14.15)

GRADE 100

Model No.	For Chain Diameter Size"	Working Load Limit lbs. (tons)
CLEVIS GRAB HOOK		
LU877	5/16	5700 (2.85)
LU878	3/8	8800 (4.4)
LU879	1/2	15,000 (7.5)
LU880	5/8	22,600 (11.3)

Model No.	For Chain Diameter Size"	Working Load Limit lbs. (tons)
CLEVIS SLING HOOK W/LATCH		
LU881	5/16	5700 (2.85)
LU882	3/8	8800 (4.4)
LU883	1/2	15,000 (7.5)
LU884	5/8	22,600 (11.3)

Model No.	For Chain Diameter Size"	Working Load Limit lbs. (tons)
CLEVIS SLING HOOK W/LOCKING LATCH		
LU885	5/16	5700 (2.85)
LU886	3/8	8800 (4.4)
LU887	1/2	15,000 (7.5)
LU888	5/8	22,600 (11.3)



SELF LOCKING SWIVEL HOOKS

- Permanently embossed with VDG, size, model number and trace code
- Proof tested to 2.5 times the Working Load Limit (WLL)
- Material: Alloy Steel
- Meets or exceeds ASTM A-952-96 standard
- Meets EN1677 standard (20,000 cycle fatigue test)

Model No.	For Chain Diameter Size"	Working Load Limit lbs. (tons)
GRADE 80, EYE & SELF-LOCKING HOOK		
LU862	5/16	4500 lbs. (2.25 tons)
LU863	3/8	7100 lbs. (3.55 tons)
LU864	1/2	12000 lbs. (6 tons)
LU865	5/8	18100 lbs. (9.05 tons)
LU866	3/4	28300 lbs. (14.15 tons)

Model No.	For Chain Diameter Size"	Working Load Limit lbs. (tons)
GRADE 100, EYE & SELF-LOCKING HOOK		
LU893	5/16	5700 lbs. (2.85 tons)
LU894	3/8	8800 lbs. (4.4 tons)
LU895	1/2	15000 lbs. (7.5 tons)
LU896	5/8	22600 lbs. (11.3 tons)



COUPLING LINKS

- Permanently embossed with VDG, size, model number and trace code
- Proof tested to 2.5 times the Working Load Limit (WLL)
- Material: Alloy Steel
- Meets or exceeds ASTM A-952-96 standard
- Meets EN1677 standard (20,000 cycle fatigue test)

Model No.	For Chain Diameter Size"	Capacity lbs.
GRADE 80		
LU867	9/32	3500
LU868	3/8	7100
LU869	1/2	12000
LU870	5/8	18100
LU871	3/4	28300
LU872	7/8	34200

Model No.	For Chain Diameter Size"	Capacity lbs.
GRADE 100		
LU873	9/32	4300
LU874	3/8	8800
LU875	1/2	15000
LU876	5/8	22600



HOISTS & LOAD INDICATORS

TIRFOR™ HOISTS

- Safe and reliable for lifting, pulling and handling a wide variety of loads
- One man operated cranking telescope handle
- Two jaw system similar to pulling a rope by hand
- Forward and reverse mode
- Griphoist designed specially for grip hoist wires with one hooked end
- Rescue Kit Includes: Steel box, Tirfor® TU series hoist, 60' Galvanized Wire Rope w/safety hook mounted on carrying reel, Telescopic handle, Snatch block pulley, 6' Wire rope sling w/choker hook, 6' Wire rope sling, 9' Wire rope sling



Model No.	Mfg. No.	Wire Dia. "	Rope Travel /Stroke Lifting"	Min. Wire Rope Break Strength lbs.	Capacity lbs. (tons)
LA699*	TU17	5/16	2	10 000	2000 (1)
LA700*	TU28	7/16	1.7	20 000	4000 (2)
LA701*	TU32	5/8	0.7	40 000	8000 (4)
LA696*	T508D	5/16	2	10 000	2000 (1)
LA697*	T516D	7/16	2.2	20 000	4000 (2)
LA698*	T532D	5/8	1.2	40 000	8000 (4)

RESCUE KITS

Model No.	RESCUE TU	Wire Dia. "	Rope Travel /Stroke Lifting"	Min. Wire Rope Break Strength lbs.	Capacity lbs. (tons)
LV073	RESCUE TU17K	5/16	2	10 000	2000 (1)
LV074	RESCUE TU28K	7/16	2.2	20 000	4000 (2)
LV075	RESCUE TU32K	5/8	1.2	40 000	8000 (4)

* Wire rope sold separately

GRIPWINCH® MOBILE ELECTRIC WIRE ROPE HOIST

- Motorized traction hoist built for lifting and pulling in a wide variety of applications
- Works in any direction
- Wire Diameter: 5/16"
- Motor Type: Single Phase
- Wire rope sold separately
- Meets CSA and UL Requirements

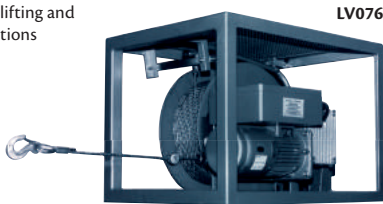

F.O.B. Montreal, Qc



Model No.	Mfg. No.	Amperage A	Reel Length Capacity m	Lift Speed FPM	Capacity lbs. (tons)
LV076	MG300-50	5.2	50	33	700 (0.35)
LV077	MG500-50	8.7	50	33	1100 (0.55)
LV078	MG700-50	9.4	50	33	1500 (0.75)
LV079	MG1020-50	9.4	50	33	2200 (1.1)
LV080	MG500-500	8.7	500	33	1100 (0.55)
LV081	MG700-500	12	500	33	1500 (0.75)
LV082	MG1020-50	9.4	50	33	2200 (1.1)

Other models available upon request

MINIFOR® PORTABLE ELECTRIC WIRE ROPE HOIST

- Portable and powerful for unlimited lifting height
- High power to weight ratio
- Upper and lower adjustable end limit stops
- Motor integrated brake • Aluminum alloy body
- 115V standard, Single Phase
- Wire Diameter: 1/4" • Wire Rope Length: 33' - 200'
- Optional wireless remote control available upon request
- Wire rope sold separately



F.O.B. Montreal, Qc



Model No.	Mfg. No.	Lift Speed FPM	Sheaved Lifting Speed FPM	Sheaved Working Load Limit lbs.	Capacity lbs. (tons)
LV083	260999	50	440	25	220 (0.11)
LV084	261019	17	1320	8.5	660 (0.33)
LV085	261079	43	1320	21	660 (0.33)
LV086	261039	23	2200	11.5	1100 (0.55)
LV087*	261059	23	2200	11.5	1100 (0.55)

ACCESSORIES

LV088	18597	Minifor® Sheave Block Pulley Kit for LV083 & LV084
LV089	18607	Minifor® Sheave Block Pulley Kit for LV085, LV086 & LV087

*220 V

HANDIFOR® MINI WEIGHER LOAD INDICATOR

- Built to measure small forces or loads in different environments
- Temperature range: from -10°C to 50°C (14°F to 122°F)
- Units of measure: lbs. and kg
- 9/16 in. (14 mm) LCD digits
- Power supply: two 1.5 V "AAA" batteries
- IP 40 protection
- Supplied with a snap shackle and a "S" hook

F.O.B. Montreal, Qc



Model No.	Mfg. No.	Accuracy lbs. (tons)	Increment lbs./kg	Working Load Limit lbs./kg
LV247	199919	± 0.2 / 0.1	0.2 / 0.1	40 (0.02)
LV248	199929	± 0.6 / 0.3	0.4 / 0.2	100 (0.05)
LV249	199939	± 1.1 / 0.5	0.4 / 0.2	200 (0.1)
LV250	199949	± 2.2 / 1	1.1 / 0.5	400 (0.2)



DYNAFOR® LLXH LOAD INDICATOR

- Measure hanging loads in pounds or kilograms, and tensile forces (N)
- The radio connection (2.4 GHz) with 260 ft. (80 m) working range is permanent between the Dynafor® sensor and the display unit
- The sensor generates an electrical signal that is proportional to the load
- Signal is processed by a micro-processor analyser and then transmitted via radio waves to the display unit, which immediately displays the load applied to the sensor to which it is linked
- Accuracy: ±0.2% of nominal capacity
- Operating temperature range from -4 to 104°F (-20 to 40°C)
- Power supply: three 1.5 V "AA" batteries

F.O.B. Montreal, Qc



Model No.	Mfg. No.	Accuracy lbs./kg	Working Load Limit lbs. (tons)
DYNAFOR® LLXH SENSOR ONLY			
LV276	193139	± 66/30	30 000 (15)
LV277	193149	± 110/50	50 000 (25)
LV278	193159	± 220/100	100 000 (50)
LV279	193169	± 440/200	200 000 (100)

DYNAFOR® LLXH SENSOR & DISPLAY

LV280	193179	± 1100/500	500 000 (250)
LV281	193089	± 66/30	30 000 (15)
LV282	193099	± 110/50	50 000 (25)
HM671	193109	± 220/100	100 000 (50)
HM672	193119	± 440/200	200 000 (100)

HM617



DYNAFOR® LLXi LOAD INDICATOR

- Dynamometers are precision force sensors used to measure forces and indicate loads
- Enables the use of standard shackles on both ends
- The sensor generates an electrical signal that is proportional to the load
- This signal is processed by a micro-processor analyser and then displayed on a built in LCD display
- Wireless range up to 131 ft. (40 m)
- Precision: ±0.2% of the full scale

F.O.B. Montreal, Qc



Model No.	Mfg. No.	Accuracy lbs./kg	Increment lbs./kg	Working Load Limit lbs. (tons)
HM665	210269	± 2.2/1	-	1000 (0.5)
HM666	210279	± 4.4/2	-	2000 (1)
HM667	210289	± 8.8/4	-	4000 (2)
LV256	210299	± 13.2/6	2/1	6400 (3.2)
HM668	210309	± 22/10	-	10000 (5)
LV257	210319	± 28.6/13	5/2	12600 (6.3)
HM669	210329	± 55/25	-	25000 (12.5)
HM670	210339	± 88/40	-	40000 (20)



RUBBER WHEEL CHOCKS

- Highly resistant to abrasion, impacts, corrosion, sun, salt, ozone and oil
- Steel ring on back
- 6 1/2" W x 7 1/2" H x 9 1/2" D
- Weight: 12.5 lbs.

Model No. KH032



RUBBER CHOCKS

Fabricated of a resilient rubber compound, reinforced for maximum wearability and strength.



Type A - May be used with chains

Type B - Traditional eyebolt for sturdy chain connection

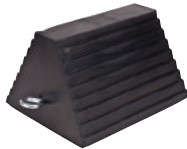

Model No.	Type	Approx. Size W" x L" x H"	Wt. lbs.
KH600	A	8 x 9 x 6	10
KH601	B	8 x 9 x 6	10

RUBBER WHEEL CHOCKS

- Constructed of reinforced rubber
- Resists tearing, abrasions, impacts, corrosion, sun, salt, and oil
- Handle on back for easy placement
- 9 7/8" L x 7 1/8" W x 7 1/2" H
- Weight: 9.5 lbs.

Model No. KH893



URETHANE WHEEL CHOCKS

- Safety orange for greater visibility
- Molded-in hole through width of chock for attaching security chain (chain sold separately)
- Overall size: 11" L x 8" W x 8" H

Model No. KH897

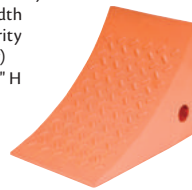

PREVENT ACCIDENTS!

Chocks are designed to provide maximum gripping power on practically any surface, wet or dry. They are resistant to sun, moisture, salt, oil and meet OSHA requirements



ICE CHOCKS

- Formed steel
- "Tooth" like bottom assures reliable grip
- Maximum holding power for snow and ice
- Overall dimensions: 10 1/2" L x 8" W x 9 1/4" H
- Powder-coated safety yellow finish for high visibility

Model No. KH964

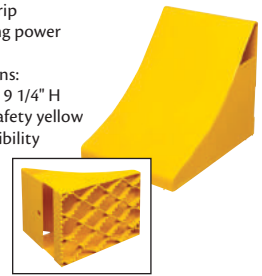

LAMINATED RUBBER CHOCKS

- Designed to fit curvature of tire for a strong grip
- Extra heavy duty laminated rubber and steel construction for use with heavy utility trucks and equipment. Load capacity: Up to 40 000 lbs.

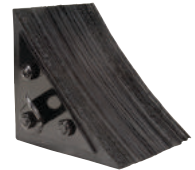

Model No.	Approx. Size W" x L" x H"	Wt. lbs.
KH603	8 x 8 x 8	14

WHEEL CHOCK ACCESSORIES

18' SECURITY CHAIN W/HOOK

- Weight: 4 lbs.

Model No. KH027



10" X 14" CAUTION SIGNS

- Black letters on yellow field
- Weight: 6 oz.
- Vinyl

Model No. SAT137 English
Model No. SEE554 French



SAT137



SEE554

WHEEL CHOCK WALL BRACKETS

- Sturdy yellow metal construction
- Fits wheel chocks up to 10" wide
- Prevents loss of chock

Model No. KH963



Model No.	Description
KH027	18' Security Chain w/Hook
SAT137	English Caution Sign
SEE554	French Caution Sign
KH963	Wheel Chock Wall Bracket

IRON WHEEL CHOCKS

Suited for your toughest jobs.

Colour:

- KH799 - Blue
- KH951 - Safety Yellow
- KH017 - Natural

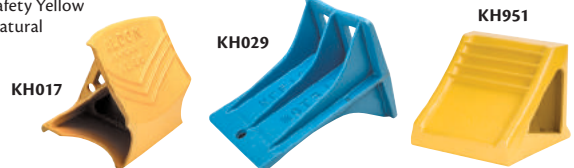

Model No.	Chock Material	Dimensions			Wt. lbs.		
		W"	x	H"			
KH951	Ductile Iron	8 1/2	x	7 1/4	x	8 1/2	15
KH799	Ductile Iron	8	x	12	x	9	19
KH017	Ductile Iron	10	x	10 1/2	x	10 3/4	23

ALUMINUM WHEEL CHOCKS

High in strength but lightweight. Resists the effects of oil, salt, corrosion and weather. Non-sparking.



Model No.	Dimensions			Wt. lbs.
	W"	x	H"	
KH023	7	x	6	4
KH801	9 1/2	x	6 1/2	4
KH022	7	x	11 1/2	6

WHEEL CHOCKS

WHEEL CHOCK REFERENCE GUIDE

Select a wheel chock based on the gross operating weight and tire diameter of the vehicle.



TIRE DIAMETER RANGE

	Up to 32" Dia.	Up to 35" Dia.	Up to 38" Dia.	Up to 46" Dia.	Up to 65" Dia.	Up to 95" Dia.	Up to 105" Dia.	Up to 142" Dia.	Up to 165" Dia.	
GROSS VEHICLE OPERATING WEIGHT	Up to 30 000 lbs.	KH971 KH966	KH971	KH968	KH968	KH977 M0005	KH978	KH978	—	—
	Up to 40 000 lbs.	KH970 KH967	KH970	KH969	KH969	KH977 M0005	KH978	KH978	—	—
	Up to 50 000 lbs.	KH967	KH968	KH969	KH969	KH977, M0005	KH978	KH978	—	—
	Up to 60 000 lbs.	KH968 KH967	KH968	KH969 KH972 KH973	KH969 KH974 KH975	KH977 M0005	KH978	KH978	—	—
	Up to 70 000 lbs.	KH969	KH969	KH792 KH973	KH974 KH975	KH977 M0005	KH978	KH978	—	—
	Up to 80 000 lbs.	KH792 KH973	KH792 KH973	KH792 KH973	KH974 KH975	KH977 M0005	KH978	KH978	—	—
	Up to 150 000 lbs.	—	—	—	KH974 KH975	KH977 M0005	KH978	KH978	KH980	KH979
	Up to 245 000 lbs.	—	—	—	KH977	KH977 M0005	KH978	KH978	KH980	KH979
	Up to 366 000 lbs.	—	—	—	—	KH025	KH978	KH978	KH980	KH979
	Up to 550 000 lbs.	—	—	—	—	KH978	KH978	KH978	KH980	KH979
	Up to 855 000 lbs.	—	—	—	—	KH980	KH980	KH980	KH980	KH979
	Up to 1 600 000 lbs.	—	—	—	—	KH979	KH979	KH979	KH979	KH979

Note: A minimum of four wheel chocks must be used for gross vehicle operating weights from 855 000 - 1 600 000 lbs

GENERAL PURPOSE POLYURETHANE WHEEL CHOCKS

- Durable polyurethane construction
- Ideal for use with over-the-road trucks, trailers, pickups and utility vehicles
- Resistant to oils, fuels and solvents
- Easy-grip carrying handle
- Eyebolt for ropes or chains
- Colour: High visibility orange



KH966



KH968

Model No.	Mfg. No.	Overall Dimensions L" x W" x H"	Wt. lbs.
KH966	UC1400-4.5	10 x 8 1/2 x 5	4.5
KH967	UC1400-6	10 x 8 1/2 x 5	6
KH968	UC1500-4.5	11 1/2 x 9 x 8 1/2	4.5
KH969	UC1500-6	11 1/2 x 9 x 8 1/2	6
KH970	UC1700	11 1/4 x 8 x 8 1/4	3.5
KH971	UC1700	8 1/2 x 7 1/2 x 6 1/4	2

ALL-TERRAIN HEAVY-DUTY POLYURETHANE WHEEL CHOCKS

- Durable polyurethane construction
- Ideal for use with underground mining equipment, fire fighting and large utility vehicles
- Resistant to oils, fuels and solvents
- Easy-grip carrying handle
- Includes replaceable aluminum traction cleats or rubber pads
- Colour: Safety yellow



KH792

Model No.	Mfg. No.	Overall Dimensions L" x W" x H"	Base Configuration	Wt. lbs.
KH792	AT3512-AC	15 1/2 x 8 1/2 x 8 1/4	Aluminum Ice Cleat	6.9
KH973	AT3512-RP	15 1/2 x 8 1/2 x 8 1/4	Rubber Pad	6.7
KH974	AT3514-AC	21 x 11 1/4 x 12 1/4	Aluminum Ice Cleat	15.7
KH975	AT3514-RP	21 x 11 1/4 x 12 1/4	Rubber Pad	16.7

HEAVY-DUTY POLYURETHANE WHEEL CHOCK

- Max Gross Vehicle Operating Weight: 245 000 lbs.
- For Tire Diameter: 46" to 65"
- Durable polyurethane construction
- Safety orange for greater visibility
- Resistant to oils, fuels and solvents
- Ideal for use with ground vehicles and heavy equipment
- Payloads up to 70 tons when using 2 x wheel chocks



Model No.	Colour	Dimensions W" x D" x H"	Wt. lbs.
M0005	Orange	14 x 17 x 14	25

HEAVY-DUTY POLYURETHANE WHEEL CHOCKS

- Durable polyurethane construction
- Ideal for use with ground vehicles and heavy equipment
- Resistant to oils, fuels and solvents
- Easy-grip carrying handle
- Mounting hole for ropes, chains or brackets
- Includes replaceable rubber pads
- Optional studs available for increased traction on snow and ice
- Colour: Safety yellow



KH977

Model No.	Mfg. No.	Overall Dimensions L" x W" x H"	Wt. lbs.
KH977	MC3009	15 x 15 1/10 x 11	14.5
KH978	MC3010	17 7/10 x 15 1/2 x 10	19
KH979	MC3011	24 3/5 x 14 1/2 x 16	32
KH980	MC3012	21 9/10 x 14 9/10 x 10 3/5	23.75

LINEBACKER® CABLE PROTECTORS

- Most robust cable protection option
- High load bearing capacity for heavy equipment applications
- Ideal for: Manufacturing, Oil and gas, mining, military, construction and heavy-duty applications
- Protects cables and hoses
- All-weather polyurethane construction
- Easy to transport, setup, disassemble, and store
- Thick lid and base allow for high volume of traffic
- Modular interlocking design



Model No.	Mfg. No.	No. of Channels	Dimensions W" x L" x H"	Channel W" x H"	Max. Load Capacity lbs./tons	
					Tire	Axle
KH702	CP1X125-GP-0	1	11.5 x 36 x 1.625	1.25 x 1.25	23 400/11.7	11 700/5.85
KH699	CP2X325-Y/O	2	22 x 36 x 4.13	3.25 x 3.25	10 880/5.44	21 760/10.88
KH695	CP3X225-Y/O	3	20 x 36 x 3.05	2.25 x 2.25	14 210/7.105	28 400/14.21
KH691	CP4X125-Y/O	4	20 x 36 x 2.31	1.85 x 1.35	20 150/10.075	40 300/20.15
KI046	CP4X300-Y/O	4	23.9 x 36 x 3.9	3 x 3	10 100/5.05	20 200/10.1
KH700	CP5X125-GP-0/Y	5	17.25 x 36 x 1.9375	1.3 x 1.3	10 500/5.25	21 000/10.5
KH687	CP5X125-Y/O	5	20 x 36 x 2.31	1.35 x 1.35	20 150/10.075	40 300/20.15

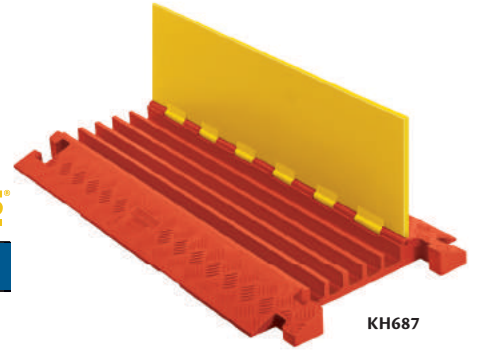

KH687

GUARD DOG® LOW PROFILE CABLE PROTECTORS

- Protects cables and hoses
- Modular interlocking design
- Thick lid and base allow for high volume of traffic
- Easy to transport, setup, disassemble, and store
- Most versatile cable protection option
- Solid construction for pedestrian traffic, and over the road vehicles
- Ideal for: Utility, industrial, entertainment



Model No.	Mfg. No.	No. of Channels	ADA/DDA Access	Dimensions W" x L" x H"	Channel W" x H"	Max. Load Capacity lbs./tons	
						Tire	Axle
KI120	GD1X75-ST-0/B	1	No	10.81 x 36 x 1.25	2.25 x 0.75	13 000/6.5	26 000/13
KI117	GD1X75-0/B	1	Yes	27.25 x 36 x 1.25	2.25 x 0.75	23 000/11.5	46 000/23
KI125	GD2X75-ST-0/B	2	No	11.94 x 36 x 1.25	1.5 x 0.75	13 000/6.5	26 000/13
KI122	GD2X75-0/B	2	Yes	28.38 x 36 x 1.25	1.5 x 0.75	23 000/11.5	46 000/23
KI136	GD3X75-ST-0/B	3	No	13.8 x 36 x 1.25	1.25 x 0.75	17 000/8.5	34 000/17
KI133	GD3X75-0/B	3	Yes	30.3 x 36 x 1.25	1.25 x 0.75	27 000/13.5	54 000/27
KI131	GD3X225-0/B	3	No	20 x 36 x 3	2.25 x 2.25	14 210/7.1	28 420/14.21
KI151	GD5X75-ST-0/B	5	No	16.9 x 36 x 1.25	1.28 x 0.75	24 000/12	48 000/24
KI148	GD5X75-0/B	5	Yes	33.3 x 36 x 1.25	1.28 x 0.75	34 000/17	68 000/34
KI146	GD5X125-0/B	5	No	19.75 x 36 x 1.875	1.339 x 1.325	10 500/5.25	21 000/10.5

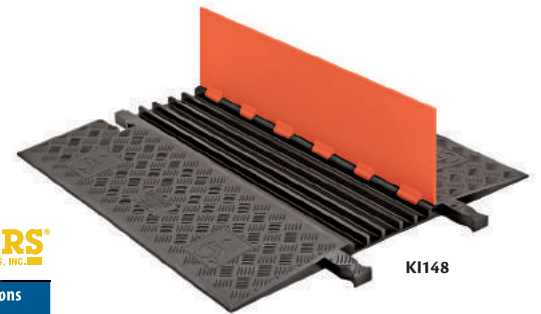

KI148

GRIP GUARD® LIGHT-DUTY CABLE PROTECTOR

- Made from tough, high impact absorbing, non-conductive polyurethane
- Resistant to oil, fuels and lubricants
- Recessed carrying handle molded in to the underside of the protector
- Super lightweight: Up to 75% lighter than standard cable protectors
- Ideal for: Entertainment, light commercial and utility applications



Model No.	Mfg. No.	No. of Channels	Dimensions W" x L" x H"	Channel W" x H"	Max. Load Capacity lbs./tons	
					Tire	Axle
KH981	GG5X125-Y/GRY	5	16 4/9 x 36 x 1.6	1.25 x 1.25	5000/2.5	10 000/5
KH986	GG3X225-Y/GRY	3	18.2 x 36 x 2.67	2.25 x 2.25	5000/2.5	10 000/5

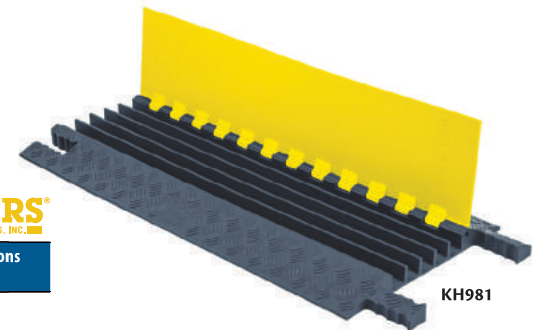

KH981

INDUSTRIAL CORD COVERS

- Protect your cables from foot and vehicular traffic
- Constructed from non-conductive vulcanized rubber
- Suitable for indoor and outdoor use
- Withstands car and light truck traffic up to 5000 lbs. per axle
- Stronger and longer lasting than PVC covers
- Excellent in temperatures from -40°C to 150°C
- Black with yellow safety stripe



5' Model No.	10' Model No.	Description	Dimensions W" x H"	Channel W" x H"
KH907	KH908	1 Channel	3 1/4 x 3/4	3/4 x 1/2
KH909	KH910	1 Channel	3 x 1	1 x 3/4
KH911	KH912	2 Channels	5 1/2 x 1 1/8	7/8 x 3/4
KH913	-	1 Channel	6 x 17/8	1 1/2 x 1 1/2

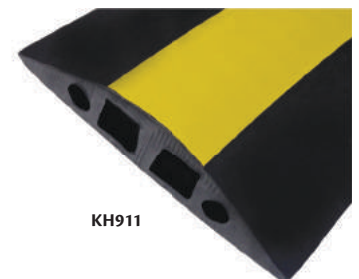

KH911

SAFETY GUARDS

INDUSTRIAL SAFETY GUARDRAILS

- Modular design of barrier guards allows you to design a system that meets specific equipment and property safeguarding needs
- 12-gauge steel rails offer enough strength to withstand a 10 000-lb load from breaking through at 6 km/h when properly installed
- Posts are available in single and double height and are 5" x 5" with 10" x 10" base plates
- Single posts are 17" high and double are 44" high, rails are 12" high
- Powder coat safety yellow finish for durability and visibility
- All necessary installation hardware included except for anchors

F.O.B. TERREBONNE, QC



RAILS

Model No.	Guardrail Height"	Nominal Length"	Wt. lbs.
KH833	12	24	18
KH832	12	36	24
KH831	12	48	30
KH830	12	60	37
KH829	12	72	43
KH828	12	84	50
KH827	12	96	58
KH826	12	108	64
KH825	12	120	70

POSTS

Model No.	Description	Wt. lbs.
KH834	Modular Guardrail Post Single 17" Height	35
KH835	Modular Guardrail Post Double 44" Height	60

RACKING AISLE PROTECTORS

- Prevent collision damage to shelving/racking from fork lifts, pallet trucks or other in-plant vehicle accidents
- Corner wraps are 12" high with an angle of 5" H x 3" W x 1/4" D with holes for anchoring to the floor
- Protectors can be customized to any other lengths and/or depths required
- Floor anchors not included • Overall Width: 3"
- Overall Height: 12" • Colour: Safety Yellow
- Material: Steel • All welded construction

Model No.	Description	Overall Length"	Fits Racking Uprights
RN059	Single Wrap - Left	46-1/2	42" W
RN060	Single Wrap - Right	46-1/2	42" W
RN061	Single Wrap - Left	52-1/2	48" W
RN062	Single Wrap - Right	52-1/2	48" W
RN063	Double Wrap	50-1/4	42" W
RN064	Double Wrap	56-1/4	48" W

CORNER PROTECTORS

- Corner Protectors help prevent damage to walls in areas with forklifts, hand trucks and other warehousing traffic
- These guard high-visibility yellow
- Made with high density polyethylene (HDPE)
- Crack and chipp resist
- Feature unique energy absorbing construction
- Anchors not included
- Can be mounted end to end
- Sold in sets of 2 protectors



Model No.	Dimensions					Wt. lbs.
	L"	x	W"	x	H"	
KH994	10	x	6	x	21	10
KH995	10	x	6	x	42	20



WALL PROTECTORS

- Wall Protectors help prevent damage to walls in areas with forklifts, hand trucks and other warehousing traffic
- These guard high-visibility yellow
- Made with high density polyethylene (HDPE)
- Crack and chipp resist
- Feature unique energy absorbing construction
- Anchors not included
- Can be mounted end to end
- Sold in sets of 2 protectors



Model No.	Dimensions					Wt. lbs.
	L"	x	W"	x	H"	
KH996	42	x	2	x	6	8
KH997	42	x	2	x	10	14



PALLET RACK BACK GUARDS

Back guards help prevent accidents by keeping pallets and their contents from falling off the back of the rack. These guards increase safety where pedestrian pathways are behind the rack.

- Constructed using a 10-gauge frame, and 2" x 2", 10-gauge wire mesh with stiffeners
- Available in a variety of sizes to fit most pallet rack configurations
- Guard brackets are designed to fit almost any style of rack
- Durable safety yellow finish
- Hardware not included

KD131



ML231



KLETON

Create a pallet rack back guard designed for your application

1. Choose one or a combination of back guard panels to create the required width and length

Model No.	Dimensions'	Weight lbs.
KH926	1 x 4	10
KH914	2 x 4	12
KH930	3 x 4	20
KD130	4 x 4	23
KD131	8 x 4	45

2. Choose a mounting bracket that provides the required depth
 - Minimum of four brackets required

Model No.	Dimensions"	Weight lbs.
ML231	4 x 6	2
ML232	4 x 9	2
ML233	4 x 12	3

3. Hardware required

For each additional panel, add: 2 x **MMB721** and 2 x **MMH254**
 For each mounting bracket, add: 3 x **MMP624** and 3 x **MMB721**



RN063



PERIMETER GUARDS

- Create your own barrier guards with two styles to choose from: 2" x 2" welded wire mesh or 2" square tube
- Both feature a unique 49 1/2" overall height, and are easily installed
- Posts are constructed of 2" square tube with 5/16" base plate with holes for anchoring to floor
- Hardware to attach add-on sections is included
- Safety yellow or Kleton blue finish



KLETON

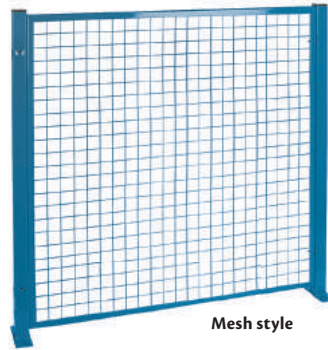

Mesh style

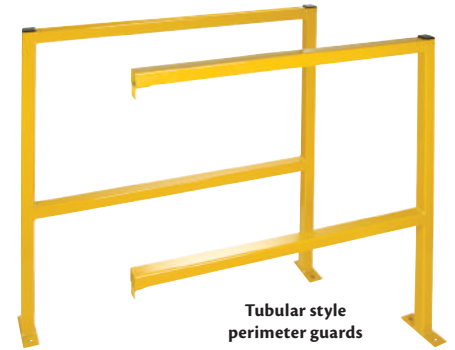

Tubular style perimeter guards

MESH STYLE KITS

Description	Dimensions W" x H"	Wt. lbs.	Blue Model No.	Yellow Model No.
Starter Section	48 x 48	46	KH945	RL848
Add-On Section	48 x 48	34	KH946	RL849
Starter Section	96 x 48	65	KH947	RL850
Add-On Section	96 x 48	53	KH948	RL851

Note: Includes assembly fasteners, floor anchors and post caps

MESH STYLE INDIVIDUAL COMPONENTS

Description	Dimensions W x H	Wt. lbs.	Blue Model No.	Yellow Model No.
Mesh Panel	4' x 4'	20	KD036	KD130
Mesh Panel	8' x 4'	39	KD037	KD131
Post Universal	49 1/2" H	13	KH861	KD129
Post Universal	99" H	22	KD053	KH860

HARDWARE REQUIRED

Model No.	Description
KD001	Floor Anchors (Two per Post)
MMH262	5/16" x 3" Carriage Bolt (Four per Frame)
MMB721	5/16" Hex Nut (One Nut for Each MLK389)
KD116	Post Caps (One per Post)

BOLLARDS

- Protect your warehouse equipment, as well as high traffic areas with these heavy-duty steel bollards
- 4" x 4" square tube welded to an 8" x 8" x 1/2" steel base, complete with four 3/4" diameter holes for anchoring to floor
- Safety yellow powder coated finish



KLETON

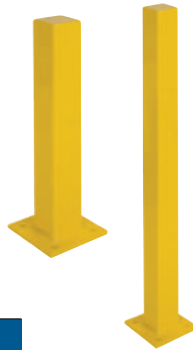

Model No.	Height"	Wt. lbs.
KD125	24	30
KH857	36	40
KD126	48	50

UPRIGHT PROTECTOR

- Protects industrial racking from damaging impacts that cause unsafe conditions
- Made from 1/4" thick steel
- 4 pre-drilled holes made for 1/2" anchors (not included)
- Safety yellow powder coated finish



KLETON



Model No.	W"	O.A. Dimensions x D" x H"	Wt. lbs.
KH858	7	x 7 x 12	12
RB925	7	x 7 x 18 1/4	15

TUBULAR STYLE

Model No.	Description	Dimensions W' x H"	Wt. lbs.
KD132	Starter Section	4 x 49 1/2	45
KD133	Add-On Section *	4 x 49 1/2	32
KD134	Starter Section	8 x 49 1/2	66
KD135	Add-On Section *	8 x 49 1/2	53

*Hardware to attach add-on section is included

HARDWARE REQUIRED

Model No.	Description
KD001	Floor Anchors (2 per post)
KD116	Post Caps (1 per post)

SAFETY GUARDS

- Protect your equipment and personnel from accidental damage and injury with these low profile safety guards
- 4" x 4" square tube welded to an 8" x 8" x 1/2" base, complete with four 3/4" diameter holes for anchoring to floor
- Colour: Safety yellow powder coat finish



KLETON

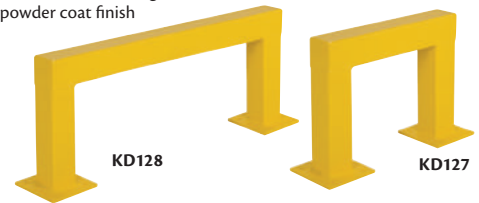

Model No.	Dimensions W" x H"	Wt. lbs.
KD127	24 x 18	65
KH855	36 x 18	75
KD128	48 x 18	85
KD136	24 x 42	95
KD856	36 x 42	110
KD139	48 x 42	115

FLOOR ANGLE GUARD RAILS

- Floor angle guide rail helps keep traffic away from racking and shelving, walls, storage areas, offices, and other work areas
- The sturdy 5" H x 3" W x 1/4" D angle iron comes with holes to anchor to the floor
- Protectors can be customized to any other lengths and/or depths required
- Floor anchors not included
- Overall Width: 3"
- Overall Height: 5"
- Colour: Safety Yellow
- Material: Steel
- All welded construction



KLETON

Model No.	Overall Length"	Wt. lbs.
RN065	48	26
RN066	60	33
RN067	120	66

SECURITY GATES & PROTECTORS

SOFT EDGE FLEXIBLE WARNING & PROTECTION SYSTEMS

- Tough, flexible polyurethane foam extrusions reduce the risk of personnel injury at high risk corners
- When applied to machinery, furnishings and walls, Soft Edge prevents impact damages by absorbing even the hardest of impacts
- Highly visible black and yellow markings offer permanent warning in dangerous areas
- Simple "peel-away" adhesive installation on grease-free surfaces
- Excellent temperature range from -40°C to 100°C



Style	Model No. 1 Metre	Model No. 5 Metres
A	KH866	KH865
B	KH868*	KH867*
C	KH870	KH869
D	KH872	KH871
E	KH952	KH953
F	KH954	KH955
G	KH956*	KH957*
H	KH958	KH959

*Held by pressure fit, not peel-away adhesive

COLUMN PROTECTORS

- Protect your building's columns from damaging bumps by moving vehicles
- 100% rust proof material, linear low density polyethylene (LLDPE)
- Octagon configuration for more rebounding ability
- Flexible deflection design
- Easy to assemble, nylon fasteners (included) for breakaway ability make these extremely versatile
- Protect columns under virtually any condition and temperature down to 0°F
- Dimensions: 22" L x 22" W x 40" H
- Weight: 42 lbs.



Model No.	Inside Opening"	Opening Shape
RN049	9	Round
RN051	8 x 10	Rectangular
RN048	8	Square
RN052	12	Square
RN050	10	Square
RN047	6	Square

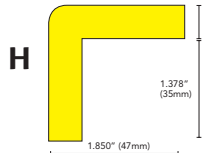
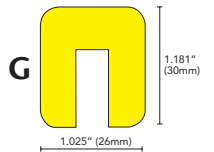
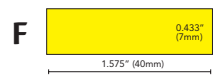
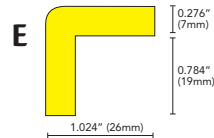
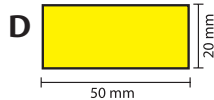
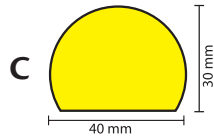
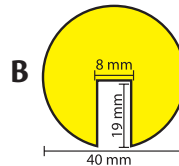
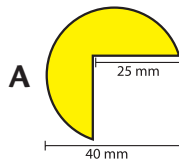

POLYETHYLENE BOLLARD COVERS

- Enhance and protect the appearance of your steel bollards
- Reduce maintenance; avoid scraping and painting each spring
- Constructed of 1/8" UV stable polyethylene for durability
- Easy installation with patented GripperTabs™ included
- Colour: Safety yellow with reflective red tape or high visibility red with white reflective tape, for great visibility day or night
- 5-year warranty against fading and cracking



Yellow Model No.	Red Model No.	Fits Bollard Diameter"	Fits Bollard Length"	Wt. lbs.
KH806	KH836	4.5	52	7
KH808	KH838	4.5	64	9
KH809	KH839	6.6	52	8
KH810	KH840	6.6	60	9
KH811	KH841	6.6	72	10

GALVANIZED FOLDING SECURITY GATES

- Secure outside access during the day and add security at night with heavy-duty, 14-gauge steel folding gates
- Constructed of galvanized steel U-channels riveted using aircraft quality rivets for durability
- Double folding gates centre drop pin rests in your pre-drilled holes to secure gate when extended
- Locks can be located on right or left side of single gates
- Durable 3" rubber casters that fully retract when not in use
- Installation hardware included

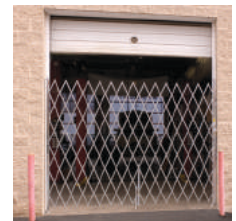

SINGLE FOLDING GATES

Lock Location		Usable Width'	Collapsed Height'	Expanded Height'	Wt. lbs.
Left Model No.	Right Model No.				
KA035	KA036	3 to 4	6.5	6	69
KA037	KA038	3 to 4	7	6.5	73
KA039	KA040	3 to 4	7.5	7	77
KA041	KA042	3 to 4	8	7.5	80
KA043	KA044	3 to 4	8.5	8	84
KA065	KA066	6 to 7	6.5	6	82
KA067	KA068	6 to 7	7	6.5	85
KA069	KA070	6 to 7	7.5	7	87
KA071	KA072	6 to 7	8	7.5	90
KA073	KA074	6 to 7	8.5	8	92
KA085	KA086	8 to 9	7	6.5	102
KA087	KA088	8 to 9	7.5	7	104
KA089	KA090	8 to 9	8	7.5	106

DOUBLE FOLDING GATES

Model No.	Usable Width'	Collapsed Height'	Expanded Height'	Wt. lbs.
KA001	8 to 10	6.5	6	144
KA002	8 to 10	7	6.5	148
KA003	8 to 10	7.5	7	153
KA004	8 to 10	8	7.5	158
KA005	8 to 10	8.5	8	162
KA006	10 to 12	6.5	6	168
KA007	10 to 12	7	6.5	172
KA008	10 to 12	7.5	7	177
KA009	10 to 12	8	7.5	182
KA010	10 to 12	8.5	8	187
KA011	12 to 14	6.5	6	180
KA012	12 to 14	7	6.5	184
KA013	12 to 14	7.5	7	189
KA014	12 to 14	8	7.5	196
KA015	12 to 14	8.5	8	199
KA016	14 to 16	6.5	6	192
KA017	14 to 16	7	6.5	196
KA018	14 to 16	7.5	7	199
KA019	14 to 16	8	7.5	201
KA020	14 to 16	8.5	8	206
KA021	16 to 18	7	6.5	204
KA022	16 to 18	7.5	7	208
KA023	16 to 18	8	7.5	211

TRAILER STABILIZING JACKS

- Keeps tractorless trailers leveled while being loaded or unloaded
- Prevents accidents if wheel support collapses
- Stabilizes vehicle against load shifts
- Lowered height: 39 1/2"
- Raised height: 51"
- Removeable 37 1/2" positioning and ratcheting handle
- 8" diameter support pad
- 8" wheels
- 100 000-lb. supporting capacity each and 40 000-lb. lifting capacity
- **Recommended use in pairs**
- **1-year warranty**

Model No. KH777



AUTO STAND TRAILER STABILIZING JACKS

- Heavy gauge steel construction
- Large base pad (17" x 18 1/2")
- Gas activated, self levelling system
- 10" diameter semi-pneumatic rubber tires for easy handling
- 41"- 50 1/2" height range
- Large trailer contact pad
- Capacity: 100 000 lbs.
- Only one required per trailer
- **1-year warranty**

Model No. KH791



SAF-T-LOK BARS

- Designed for economy and ease of operation
- Constructed with high strength industrial round tubing
- Easy to close and lock with its heavy-duty steel rack, handle and cast aluminum housing
- Replaceable molded pivoting rubber feet, 2" x 4" that grip firmly to trailer walls
- Easy to open trigger release
- Adjusts from 90" to 105"
- Optional cargo hoop set, two hoops, which bolts quickly and easily to provide greater area of holding surfaces (installation hardware included)
- Available in either steel or aluminum versions
- Extra long steel version is available upon request



One piece cargo bar adjusts from 89" to 105" long



Hoops come complete with installation hardware

KINEDYNE
The Cargo Control People!™

Model No.	Description	Wt. lbs.
KH574	Aluminum Saf-T-Lock Bar	17
KH575	Cargo Hoop Set	15

LOAD BINDERS

- Forged and heat treated
- With two strong, full rotation swivels
- Profiled mid-section to give extra stability
- Working load limit rating embossed on handle



KINEDYNE

Model No.	Chain Size"	WLL lbs.	Wt. lbs.	Type
LT465	1/4 - 5/16	2600	3.5	Lever Chain
LT466	5/16 - 3/8	5400	8.1	Lever Chain
LT467	3/8 - 1/2	9200	12.4	Lever Chain
LT462	1/4 - 5/16	2600	3.7	Ratchet Chain
LT463	5/16 - 3/8	5400	10	Ratchet Chain
LT464	3/8 - 1/2	9200	12.9	Ratchet Chain
LT468	5/16 - 3/8	5400	8.9	Recoilless Chain

AUTO STAND PLUS

- Heavy gauge steel construction
- Gas activated, self-levelling system
- Ergonomic lever action to safely pin, removing the need to bend over
- 16" diameter semi-pneumatic wheels allow for easy outdoor manoeuvring
- Large base pad: 17" x 18 1/2"
- Large trailer contact pad
- Capacity: 100 000 lbs.
- Only one required per trailer
- **1-year warranty**

Model No. ML786



PALLET PULLERS

- Efficient way to unload pallets from trucks
- Hardened teeth give positive grip in any pallet
- One-person operation
- Pulls pallets straight or sideways to get out of tight spots
- Capacity: 5000 lbs.

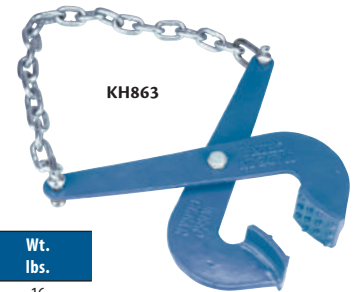

KH863

Model No.	Description	Wt. lbs.
KH863	Pallet Puller	16
LU982	20' Hook and Chain	-

GRADE 70 TRANSPORT CHAIN TIE-DOWNS

- Manufactured in accordance with the Department of Transportation regulations
- Each assembly has a rating tag attached to meet NSC Standard 10 requirements
- Includes grade 70, alloy steel clevis grab hooks on each end
- Designed for use in cargo securement, towing and logging
- Grade 70 chains must not be used for overhead lifting
- High quality stamped grade 70 chain links
- Yellow chromate finish
- Design factor 4:1



VANGUARD STEEL LTD.

Model No.	Chain Length"	Trade Size	Working Load Limit
LU982	20' (6.1 m)	5/16"	4700 lbs. (2.35 tons)
LU983	25' (7.6 m)	5/16"	4700 lbs. (2.35 tons)
LU984	20' (6.1 m)	3/8"	6600 lbs. (3.3 tons)
LU985	25' (7.6 m)	3/8"	6600 lbs. (3.3 tons)

DOCK EQUIPMENT

ALUMINUM DOCKPLATES

Skid resistant safety tread deck. Beveled edges allow smooth access from either end. Bend at upper end permits both ends of plate to lie flat. Steel legs fit between dock and truck; prevent movement when in use. High tensile aluminum alloy construction; no welds to break.



HOW TO ORDER:

1. **Select dockplate width:** add 12" to width of equipment to be used on dockplate.
2. **Determine height differential:** (the vertical distance from dock floor to truck floor) The height differential decides the necessary plate length.
3. **Select the necessary capacity.**

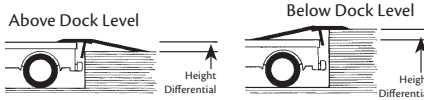

COMBINATION BOARDS

For a height differential exceeding 11", use a ramp in combination with dockplate. Each plate can be converted to an equivalent-size ramp. Call us with your requirements.



Size W" x L"	Height Diff."	Light Duty - 1/4" ga.			Regular Duty - 3/8" ga.			Heavy Duty - 1/2" ga.			Extra Heavy Duty - 5/8" ga.		
		Model No.	Cap. lbs.	Wt. lbs.	Model No.	Cap. lbs.	Wt. lbs.	Model No.	Cap. lbs.	Wt. lbs.	Model No.	Cap. lbs.	Wt. lbs.
36 x 48	7	KH206	700	53	KH148	1700	71	KH193	3000	97	-	-	-
42 x 48	7	KH207	800	60	KH153	2000	82	KH194	3500	110	-	-	-
48 x 24	3	KH208	1800	36	KH154	4500	48	-	-	-	-	-	-
48 x 30	4	KH209	1450	44	KH155	3600	60	-	-	-	-	-	-
48 x 36	5	KH210	1250	52	KH156	3000	70	KH195	5400	94	-	-	-
48 x 42	6	KH211	1050	60	KH157	2600	82	KH196	4600	110	-	-	-
48 x 48	7	KH212	900	67	KH158	2200	92	KH197	4000	124	-	-	-
48 x 54	8	KH213	760	76	-	-	-	-	-	-	-	-	-
48 x 60	9	KH214	600	83	KH159	1500	114	KH198	2700	155	-	-	-
48 x 72	11	KH215	400	100	KH160	1100	136	KH199	2000	184	-	-	-
60 x 24	3	KH216	2200	43	KH170	5600	59	KH200	10000	79	KH328	15600	98
60 x 30	4	KH217	1800	54	-	-	-	-	-	-	-	-	-
60 x 36	5	KH218	1500	63	KH171	3700	86	KH201	6700	114	KH329	10500	141
60 x 42	6	KH219	1300	73	-	-	-	-	-	-	-	-	-
60 x 48	7	KH220	1100	83	KH172	2800	113	KH202	5000	151	KH330	7800	186
60 x 60	9	KH221	880	102	KH173	2200	140	-	-	-	-	-	-
72 x 24	3	KH222	2600	51	KH174	6700	76	KH203	12000	94	KH331	18700	115
72 x 30	4	KH223	1950	63	-	-	-	-	-	-	-	-	-
72 x 36	5	KH224	1650	74	KH175	4500	105	KH204	8000	135	KH332	12600	166
72 x 48	7	KH225	1300	97	KH176	3300	135	KH205	6000	178	KH333	9400	220
72 x 60	9	KH226	900	121	-	-	-	-	-	-	-	-	-

ALUMINUM DOCKBOARDS

Ideal for truck or rail applications. Curb design adds strength and prevents equipment run-off. Skid resistant safety tread deck. Beveled edges allow smooth access from either end. Bend at upper end permits both ends of plate to lie flat. Steel legs fit between dock and truck or railcar, prevent movement when in use. High tensile aluminum alloy construction.

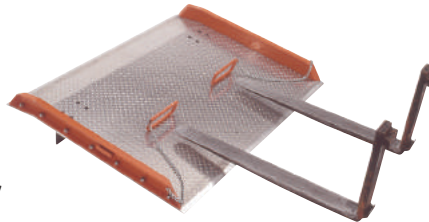

OPTIONS: RAIL DOCKBOARDS

Fixed Spanlocks provide quick and safe access between dock and railcar, or between railcars. Sold in pairs.

Model No. KH192

Adjustable Spanlocks permit use of the same board on truck or rail docks. Easily adjusted for various spans.

Sold in pairs.

Model No. KH190

OPTIONS: FORKLIFT HANDLES

Makes movement of heavy boards and plates easy and safe. Recommended for boards and plates over 140 lbs. **Sold in pairs.**

Model No. KH191

HOW TO ORDER:

1. Determine required capacity: 90% of gross weight for forklift trucks; 67% of gross weight for powered pallet trucks. Example: Wt. of Forklift + Wt. of Heaviest Load = Gross Weight x .90 = Required Capacity (5,500 lbs. + 10,000 lbs. = 15,500 x .90 = 13,500 lbs.)
2. Select dockboard width: add 12" to width of equipment to be used on dockboard.
3. Determine height differential (the vertical distance from dock floor to truck floor).

ALUMINUM WHEEL RISERS

Ideal for use when the loading dock is higher than the trailer bed. Levels out trailer with dock; facilitates loading and unloading. 24" wide. 25 000 lbs. capacity per pair.



Priced per Pair

Model No.	Height"	Deck Length"	Approach Length"	Overall Length"	Wt. lbs. /pair
KH061	6	24	21	45	124
KH062	8	24	28	52	150
KH064	10	24	35	59	178
KH066	12	24	42	66	210
KH063	6	36	21	57	164
KH068	10	36	35	71	226
KH070	12	36	42	78	263
KH067	6	48	21	69	204
KH069	8	48	28	76	238
KH071	10	48	35	83	274
KH072	12	48	42	90	316

Model No.	Width Cap. lbs.	Inside Curbs"	Overall Width"	Overall Length"	Height Diff."	Wt. lbs.
KH149	4000	51	54	60	9	164
KH150	4000	51	54	72	11	210
KH151	4000	57	60	60	9	177
KH152	4000	57	60	72	11	225
KH161	6000	51	54	48	7	143
KH162	6000	50	54	60	9	177
KH163	6000	50	54	72	11	225
KH164	6000	57	60	48	7	153
KH165	6000	56	60	72	11	240
KH166	6000	63	66	36	5	123
KH167	6000	63	66	48	7	163
KH168	6000	62	66	60	9	203
KH169	6000	69	72	48	7	174
KH177	8000	51	54	36	5	106
KH178	8000	50	54	48	7	149
KH179	8000	50	54	60	9	188
KH180	8000	50	54	72	11	236
KH181	8000	57	60	36	5	115
KH182	8000	56	60	48	7	160
KH183	8000	56	60	60	9	201
KH184	8000	56	60	72	11	251
KH185	8000	69	72	30	4	110
KH186	8000	68	72	48	7	181
KH187	8000	68	72	60	9	227
KH188	8000	68	72	72	11	282
KH189	8000	68	72	84	13	340
KH105	10000	51	54	36	5	127
KH106	10000	50	54	48	7	176
KH107	10000	50	54	60	9	222
KH108	10000	50	54	72	11	276
KH109	10000	56	60	60	9	239
KH110	10000	56	60	72	11	297
KH111	10000	63	66	36	5	148
KH112	10000	62	66	48	7	197

Model No.	Width Cap. lbs.	Inside curbs"	Overall Width"	Overall Length"	Height Diff."	Wt. lbs.
KH113	10000	62	66	60	9	256
KH115	10000	69	72	48	7	210
KH116	10000	68	72	60	9	273
KH117	10000	68	72	72	11	337
KH118	10000	68	72	84	13	403
KH119	12000	57	60	36	5	137
KH120	12000	56	60	48	7	190
KH121	12000	56	60	60	9	249
KH122	12000	69	72	36	5	158
KH123	12000	68	72	48	7	217
KH125	12000	68	72	84	13	192
KH126	14000	56	60	36	5	143
KH127	14000	56	60	48	7	190
KH128	14000	56	60	60	9	249
KH129	14000	56	60	72	11	313
KH130	14000	62	66	36	5	148
KH131	14000	62	66	48	7	204
KH132	14000	62	66	60	9	266
KH133	14000	62	66	72	11	333
KH134	14000	68	72	36	5	160
KH135	14000	68	72	48	7	220
KH136	14000	68	72	60	9	283
KH137	14000	68	72	72	11	353
KH138	14000	68	72	84	13	456
KH139	16000	68	72	60	9	330
KH140	16000	68	72	72	11	412
KH141	16000	68	72	84	13	540
KH142	18000	69	72	36	5	187
KH143	20000	68	72	36	5	187
KH144	20000	68	72	48	7	267
KH145	20000	68	72	60	9	344
KH146	20000	68	72	72	11	412
KH147	20000	67	72	84	13	564

STEEL-FACED LAMINATED RUBBER DOCK BUMPERS

- One of the strongest forms of loading dock protection
- Used in docking areas where excessive friction from up and down movement occurs, air-ride trailers, yard jockeys, etc.
- 3/8" thick, heavy duty, high carbon, "floating" steel face plate withstands abrasive friction of air-ride trailers
- Enclosed design prolongs rubber life
- 3-year warranty



Model No.	A"	B"	C"	D"	Wt. lbs.
4" PROJECTION					
HORIZONTAL STYLE					
KH705	4	12	14	7	58
KH706	4	12	18	7	72
KH707	4	12	24	7	90
KH708	4	12	36	7	145
VERTICAL STYLE					
KH709	4	20	11	7 1/2	75
KH710	4	24	11	9 1/2	90
6" PROJECTION					
HORIZONTAL STYLE					
KH712	6	12	14	7	62
KH713	6	12	18	7	78
KH714	6	12	24	7	105
KH715	6	12	36	7	166
VERTICAL STYLE					
KH716	6	20	11	7 1/2	83
KH717	6	24	11	9 1/2	100

MOLDED DOCK BUMPERS

- Protects building and dock areas
- Shockproof, tear and freeze resistant



KH005



Model No.	Type	Face size W" x H"	Overall Projection"	Wt. lbs.
KH005	Rectangular	13 x 10	4	16
KH009	Rectangular	18 x 10	4	32

LAMINATED RUBBER DOCK BUMPERS

- Unlimited applications in factories, warehouses and docks
- Ideal for projecting above low docks, rub rails against walls, marine dock protection
- Greater longevity of bumpers is achieved because rubber laminates are manufactured from reclaimed truck tires
- Manufactured under pressure exceeding 1500 lbs. to absorb over 80% of the impact
- 1-year warranty

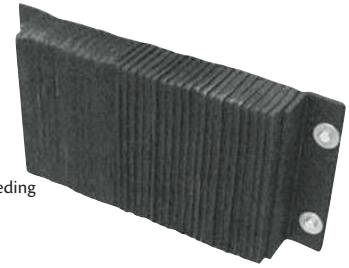

Model No.	A"	B"	C"	D"	Wt. lbs.
4" PROJECTION					
HORIZONTAL STYLE					
KH719	4	10	12	5	25
KH720	4	12	12	7	31
KH721	4	12	14	7	35
KH722	4	12	18	7	44
KH723	4	12	24	7	58
KH724	4	12	36	7	84
VERTICAL STYLE					
KH725	4	20	11	7 1/2	46
KH726	4	24	11	9 1/2	56
6" PROJECTION					
HORIZONTAL STYLE					
KH729	6	10	12	5	29
KH730	6	12	12	7	34
KH731	6	12	14	7	39
KH732	6	12	18	7	50
KH733	6	12	24	7	72
KH734	6	12	36	7	105
VERTICAL STYLE					
KH735	6	20	11	7 1/2	53
KH736	6	24	11	9 1/2	64

SELECTING THE PROPER SIZE OF DOCK BUMPER

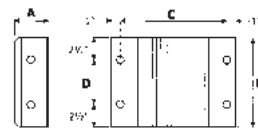

Horizontal Style — Laminated or Steel-Faced

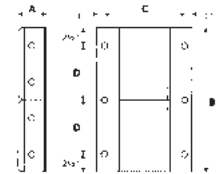

Vertical Style — Laminated or Steel-Faced

EXTRUDED RUBBER DOCK FENDERS

D-4 DOCK FENDERS

- Guard against damaging impact
- Made of age, weather and abrasion-resistant synthetic rubber
- Easy to install and the trim appearance makes them well suited for use on trucks and truck docks
- Half oval shape allows radius to widen upon impact creating better deflection
- Easily installed manually or by power tools
- Hardware is concealed when installation is complete

Note: All given dimensions are nominal and may vary an average of 5% in manufacturing process.

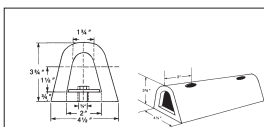

Diagonal



Horizontal



Vertical

MOUNTING D-4 DOCK FENDERS

On Wood: Use 1/2" Lag Screws

On Concrete: Use 1/2" Self-Drilling Fasteners

On Steel: Weld 1/2" Studs on Centers as Required

In all cases, a drilled metal bar 3/16" x 1 1/2" should be inserted in the bore of the fender to act as a continuous washer.



Mounting Bar

Dimensions W" x H" x L"	Anchor Holes	Approx. Wt. lbs.	Fender Drilled Model No.	Mounting Bar Drilled Model No.
4 1/2 x 3 3/4 x 12	2 req., 6"*	4	KH658	KH662
4 1/2 x 3 3/4 x 18	2 req., 12"*	6	KH659	KH663
4 1/2 x 3 3/4 x 24	2 req., 18"*	9	KH660	KH664
4 1/2 x 3 3/4 x 36	3 req., 15"*	11	KH661	KH665

* Between holes

DOCK LIGHTS

DOCK LIGHTS

- The adjustable models allow flexible horizontal and vertical positioning
- 1 1/2" 14-gauge square steel tubing
- Two-piece wall bracket assures secure mounting
- Available with either metal head or with a "cool to the touch" polycarbonate head that will not dent or break
- Comes with wire lamp guard
- PAR-38 lamp not included
- Certified for sale in Canada by an accredited certification body

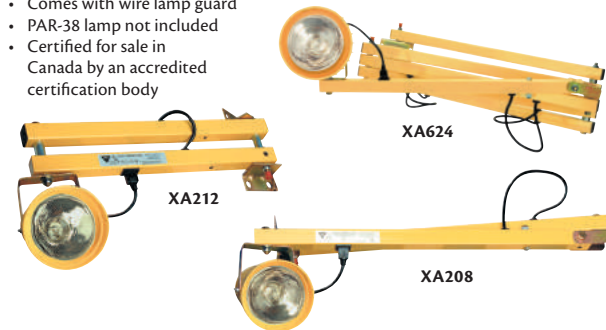

XC224
Replacement
Metal Head



XC445
Replacement
Polycarbonate Head

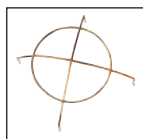

XA209
Wire Lamp Guard

LED FLEXIBLE ARM DOCK LIGHTS

- Designed to light up the longest of trailers with no wasted light
- LEDs last over 50,000 hours with low heat emission
- Flexible arm allows for unlimited positioning
- Housing is made from durable polycarbonate polymer resistant to cold temperatures
- Low energy usage of 16 W
- Light output equivalent to a 150 W PAR28 bulb
- Dimensions: 42 1/2" L x 6" H
- Weight: 12 lbs.
- Certified for sale in Canada by an accredited certification body

Model No. XC756



HALOGEN DOCK LIGHTS

- 40" full extension
- Tempered glass lens with protective wire guard
- Light fixture can pivot up and down
- Arm has spare bulb holder built in
- Suitable for wet areas
- On/Off toggle switch
- 6' cord with ground
- Includes two 500 W quartz halogen bulbs
- Certified for sale in Canada by an accredited certification body



Model No.	Description	Wt. lbs.
XA673	Dock Light	15
XC464	Replacement Bulb	-

Model No.	Arm Length"	Head Type	Wt. lbs.
ADJUSTABLE SINGLE STRUT			
XA213	40	Metal	13
XA208	60	Metal	16
XC446	40	Polycarbonate	12
XC447	60	Polycarbonate	15
DOUBLE STRUT - HORIZONTAL POSITIONING ONLY			
XA212	24	Metal	13
XA211	40	Metal	16
XA214	60	Metal	20
XA349	90	Metal	29
XC448	24	Polycarbonate	12
XC449	40	Polycarbonate	15
XC450	60	Polycarbonate	19
XC451	90	Polycarbonate	28
ADJUSTABLE DOUBLE STRUT			
XA619	40	Metal	18
XA620	60	Metal	21
XA621	90	Metal	31
XA623	40	Polycarbonate	17
XA624	60	Polycarbonate	20
XA625	90	Polycarbonate	30

ACCESSORIES

Model No.	Description
XA209	Replacement Wire Guard for Metal Head
XC731	Replacement Wire Guard for Polycarbonate Head
XC571	Replacement PAR-38 Lamp
XD043	Replacement PAR-38 LED Lamp
XC224	Replacement Metal Head
XC445	Replacement Polycarbonate Head

LED STOP & GO LIGHTS



- Simple, reliable and cost-effective warning system that reduces the risk of accidents
- Establishes a clear line of communication between drivers and dock personnel
- Safety yellow polypropylene housing will not rust, pit, dent or corrode
- Shallow depth of unit (less than most dock bumpers) prevents damage to the Stop & Go light
- Integral eyebrow-type sun visors create extended visibility
- Mounting holes conform to standard building specifications
- Units can be used indoors or outdoors
- Dimensions: 6 3/8" W x 3 3/4" D x 11 3/8" H
- Lens diameter: 4 1/4"
- Certified for sale in Canada by an accredited certification body

Uses 80% less energy



12 VDC	Model No. 24 VDC	115 VAC	Description	Wt. lbs.
XC100	XC101	XC102	Without Flasher or Switch	2
XC103	XC104	XC105	With Flasher and Switch	2
XC106	XC107	XC108	Set, Including One of Each of the Above	4

HEAVY-DUTY LED DOCK LIGHT

- 40" full extension arm with five pivot points
- Cool to the touch, even if left running for extended lengths of time
- Instant start-up, at full output, even in cold temperatures
- Rugged cast aluminum housing, tempered glass lens
- Low energy usage at 38 W
- LED array lasts for 50,000 hours
- Rated for outdoor use
- 10' power cord with 5-15P plug
- Certified for sale in Canada by an accredited certification body

Model No. XD022



POLYETHYLENE TARPULINS

- Reinforced polypropylene rope sewn-in welded hems
- Heavy-duty rust resistant grommets every 3'
- Increased UV resistance for long life
- Water resistant coating
- Finished sizes may vary due to hem allowance

NI771



STANDARD-DUTY BLUE

- 8 x 8 weave density
- 100-micrometres thick (4 mil)



Reinforced Corner

NI783
Heavy-Duty White

HEAVY-DUTY WHITE

- 10 x 10 weave density
- 150-micrometres thick (6 mil)
- Four corner patches

3-Layer Corner

JB567

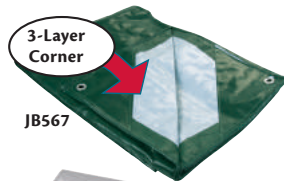

INDUSTRIAL GREEN/SILVER

- 14 x 14 high density weave
- 225-micrometres thick (9 mil)
- 9" x 9" triple layered on four corners

SUPER HEAVY-DUTY SILVER

- 16 x 16 high density weave
- 300-micrometres thick (12 mil)
- 9" x 9" triple layered on four corners
- Silver side provides heat and UV light diversion

JC626



Dimensions ¹	Model No.			
	Standard-Duty Blue	Heavy-Duty White	Industrial Green/Silver	Super Heavy-Duty Silver
5 x 7	NI768	-	-	-
6 x 8	NI769	NI780	JB567	-
8 x 10	NI770	NI781	JB568	-
10 x 12	NI771	NI782	JB569	JC626
10 x 20	NI772	-	-	JC627
12 x 16	NI773	NI783	JB570	-
16 x 20	NI774	NI784	JB571	JC628
18 x 24	NI775	JC512	-	JC629
20 x 30	NI776	JC513	JB572	JC630
24 x 30	NI777	NI785	-	JC631
30 x 40	NI778	JC514	JC516	JC632
30 x 50	JC510	JC515	JC517	JC633
30 x 60	-	-	-	JC634
40 x 50	JC511	JC625	JC518	-
40 x 60	NI779	JB508	JB573	JC635

INSULATED TARPULINS

- Lightweight and flexible, moisture resistant insulated tarpaulin
- Manufactured with 3/16" closed cell polyethylene foam insulation
- R-value is maintained in damp cold conditions
- Durable, water resistant polyethylene shell
- Heavy-duty rust resistant grommets every 2'
- R value: 1.0
- Dimensions: 12' x 20'

Model No. JD420



CLEAR TARPULINS

- Polyethylene tarpaulin with reinforced nylon gridding
- Water and mildew resistant coating
- Heavy-duty rust resistant grommets
- 3 x 3 weave density
- 200 micrometers (8-mil) thick
- Finished sizes may vary due to hem allowance



Model No.	Dimensions ¹
JD414	8 x 10
JD415	10 x 12
JD416	16 x 20
JD417	20 x 30
JD418	30 x 40
JD419	40 x 60

FURNITURE PADS

- Protect furniture from scratches when moving
- Zigzag stitching provides durability and consistent cushioning
- Cotton and polyester material
- 72" W x 80" L



PREMIUM FURNITURE PADS

- 40-oz. filling
- Dark blue/light blue
- Weight: 5.5 lbs.

Model No. PF460



PF460

STANDARD FURNITURE PADS

- 29-oz. filling
- Dark blue/green
- Weight: 5 lbs.

Model No. PF461



PF461

STRAP-ALL™ ONE INCH STRAPS

- Ratchet strap with ratchet
- Light-duty tie-down can be used on pick-up trucks utility trailers, car top racks and boat trailers



Model No.	Strap Length ¹	Breaking Strength lbs.	Working Load Limit lbs./kg
ND361	16	1200	835/380

2" LOGISTIC STRAPS

- Designed to take care of most interior van loading requirements
- Standard 48" fixed end
- Adjustable captive end to avoid loss or theft
- Comes with ratchet buckle and webbing
- Spring-loaded "E"



ND352



Model No.	Strap Length ¹	Strap Width ²	Breaking Strength lbs.	Colour	Working Load Limit lbs./kg
ND352	12	2	3000	Gold	1000/455
ND353	16	2	3000	Grey	1000/455
ND354	20	2	3000	Blue	1000/455

RUBBER TIE DOWNS

- Retains its rebound qualities
- Rot resistant
- Zinc-plated steel hooks

Model No.	Length ¹	Model No.	Length ¹
PE366	5	PE369	21
PE367	9	PE370	31
PE368	15	PE371	41



10-PC. BASIC TIE DOWN SET

Model No. PF090 Set contains: 4 PE369, 2 PE370 and 4 PE371

16-PC. ALL-PURPOSE TIE DOWN SET

Model No. PF091 Set contains: 2 PE367, 2 PE368, 4 PE369, 4 PE370 and 4 PE371

20-PC. PROFESSIONAL TIE DOWN SET

Model No. PF092 Set contains: 10 PE369 and 10 PE371



DRUMS

STEEL DRUMS

- Open head 45 imp. gal/55 US gallon design complies with stringent UN regulations for packing non-dangerous and dangerous goods in packing groups II and III; salvage drum is good for packaging groups I, II and III in solids only
- Closed head 45 imp. gal/55 US gallon design meets UN regulations for packing of dangerous and non-dangerous goods in the packaging groups II and III and also complies with ISO 15750 standard and other major international standards for steel drums (ANSI, EN) and feature 2" x 3/4" Rieke® fittings
- Drum gauge: 20/18 ga.
- Dimensions: 23" W x 35" H
- Accepted for use in Canadian food processing facilities



UN Regulations:

A) 1A2/Y1.4/140 B) 1A2/Y275/S C) 1A1/X1.8/300

Unlined Model No.	UN Compliance	Lined Model No.	UN Compliance	Head Type	Capacity U.S. Gallons	Wt. lbs.
DC145	A	DC146	B	Open	55	37
DC147*	C	DC461**	C	Closed	55	35

*Not accepted for use in Canadian food processing facilities ** Unit is white

ACCESSORIES

Model No.	Description
DC648	2" Steel Plug with Buna Gasket - Rieke
DC570	Steel Drum Lid for 55 US Gal. Drum, No Fittings
DC568	Steel Drum Locking Ring for US 55 Gal. Drum
DC569	Steel Drum Bolt Only for Locking Ring

LIQUIPAK® FIBRE DRUMS

- Interior is lined with heavy duty polyethylene
- The full-open top assures quick filling and dispensing, while the plastic covers and steel chimes reinforce top and bottom
- Will not corrode and contaminate product
- Made of FDA compliant materials
- Complete with bung and vent poly cover and locking ring
- Lined

Model No.	Capacity Gallons	Lid Material
DC548	30	Plastic
DC549	55	Plastic



LOK-RIM® FIBRE DRUMS

- Provides thermal insulation and protects sensitive products
- The unique Lok-Rim® closure allows easy opening and closing
- Will not corrode and contaminate product
- Compatible with semi-liquids when a polyethylene insert/bag is applied
- Made of FDA compliant materials
- Includes locking ring and cover
- Unlined

Model No.	Capacity Gallons	Lid Material	UN Compliance
DC543	30	Plastic	Y115
DC544	30	Steel	None
DC546	55	Fibre	None
DC547	55	Steel	Y200



STEEL SALVAGE DRUMS

- Salvage drums are recommended for containing leaking drums of petroleum solvents
- Includes 12-gauge ring and hoop closure
- Drums are lined with an open head steel top



DC445

Model No.	Capacity US Gallons	Description	UN Compliance	Steel Gauge	Wt lbs.
DC445	85	Lined	UN1A2/X440/S	18	77
DC448	85	Lined	UN1A2/X440/S	16	82
DC447	110	Lined	UN1A2/Y409	16	105

POLYETHYLENE DRUMS

- UN-approved plastic drums are manufactured using state-of-the-art technologies to meet the stringent demands of chemical compatibility with hazardous and non-hazardous products as well as reliability and safety requirements
- Drums are made from a high molecular weight, high-density polyethylene resin which makes them extremely strong and rigid
- Open head drums come standard with cover and steel lever-locking ring
- Capacity is based on US gal. readings
- Accepted for use in Canadian food processing facilities



Model No.	Capacity Gallons	Colour	Top	UN Compliance
DC525	55	Blue	Open	1H2/Y250/S
DC527	55	Black	Open	1H2/Y250/S
DC529	55	Blue	Closed	1H1/Y1.9/150
DC530	55	Black	Closed	1H1/Y1.9/150
DC531	55	Natural	Closed	1H1/Y1.9/100
DC535	30	Blue	Open	1H2/Y150/S
DC532	30	Blue	Closed	1H1/Y1.9/150
DC534	30	Natural	Closed	1H1/Y1.9/150
DC538	15.5	Blue	Open	1H2/Y65/S
DC539	10	Blue	Open	1H2/Y47.5/S

ACCESSORIES

Model No.	Description
DA019	2" Buttress Coarse Thread
DA020	2" NPS Fine Thread
DC571	Polyethylene Drum Lever Latch for 55 US Gal. Drum
DC572	Polyethylene Drum Lever Latch for 30 US Gal. Drum

POLYETHYLENE DRUMS - TIGHT HEAD

- High density polyethylene construction, can be stacked with pallets up to four high
- Maximum filling temperature of 65°C; drums should be allowed to cool to ambient temperatures before stacking
- Features 2" and 3/4" NPS fittings and manipulating handle
- Capacity is based on US Gal. readings
- Accepted for use in Canadian food processing facilities



Model No.	Capacity Gallons	Colour	Top	UN Compliance
DC540	15	Blue	Closed	1H1/Y1.9/160
DC542	15	Natural	Closed	1H1/Y1.9/160

RECTANGULAR POLY TIGHT HEAD CONTAINERS

- Suitable for storing and shipping liquid, granular and semi-solid chemicals, detergents, petroleum products, food products, pharmaceuticals and acids
- Recessed handle and anchoring
- Protruding stabilizers prevent tipping
- Vents are included but leakproof screw caps are extra
- Container capacity: 20 litres
- Dimensions: 11 1/2" L x 9 1/2" D x 9 3/4" H



Model No.	Mfg. No.	Description	Opening mm
DC163	158	Yellow Container Only*	63
DA684	240	Natural Container Only*	60
DA685	284	Security Cap	60

*Security cap not included.

ACCORDION INSERTS FOR 55-GALLON DRUMS

- Made of FDA-compliant materials
- Accordion pleat design adjusts to varying heights of reconditioned drums
- Formed lip grips chime of drum and stays in place during follower plate pumping

Model No.	Wall Thickness	Qty /Case
DC338	15 mils	20
DC340	18 mils	15
DC339*	15 mils	20

* Anti-static



STRAIGHT-SIDED INSERTS FOR 16, 30 & 55-GALLON OPEN HEAD STEEL DRUMS

- Made of FDA compliant materials
- Smooth wall inserts withstand mixing and pumping applications
- Available in anti-static
- Model DC337 used for hot-fill applications to 180°F
- Model DC344 used for hot-fill applications to 280°F

Model No.	Wall Thickness	Drum Gal.	Qty /Case
DC336	15 mil	30	25
DC337	15 mil	55	20
DC344	15 mil	55	10
DC342*	18 mil	55	15
DC343	24 mil	55	15

* Anti-static



INSERTS FOR 5-GALLON STEEL PAILS

- Made of FDA compliant materials
- Straight-sided inserts for steel pails are ideal for small batch mixing
- Choose from pliable LDPE or solvent-resistant HDPE
- Available in anti-static
- Available in polypropylene for hot-fill applications to 300°F

Model No.	Wall Thickness	Material	Qty /Case
DC347	15 mil	LDPE	100
DC348	15 mil	HDPE	100
DC349	15 mil	Polypropylene	100
DC492*	15 mil	LDPE	100

*Anti-static



PAIL INSERTS & STRAINERS

INSERT

- Seamless 14" tall tapered insert provides custom fit for plastic pail
- Average 15-mil thick
- FDA compliant materials

STRAINER

- Heavy-duty strainer ideal for filtering liquids or holding parts for washing
- Featuring 600-micron mesh, finer mesh strainers are available

Model No.	Material	Size (Gal)	Qty/Case
INSERTS			
DC350	HDPE	5	100
DC351	LDPE	5	100
STRAINER			
DC049		5	48
DB021		55	8



DRUM CLOSURES

STEEL DRUM CLOSURES

- Made from premium deep-drawing quality steel
- Visegrip® plugs have a hexagonal shoulder for easy opening (no tools required)
- Titegrip™ plugs compatible with other opening types also available

STEEL DRUM FUSIBLE CLOSURES

- Used for drums containing combustible materials
- Made of reinforced nylon material
- Centre melts away when exposed to extreme heat allowing venting, thus reducing risk of explosion
- Titegrip™ plugs compatible with other opening types also available

POLY-DRUM CLOSURES

- Poly-Visegrip® closure specially designed for use in lined containers
- Requires no gaskets

STEEL DRUM CLOSURES

Model No.	Size"
DB891	3/4
DC648	2

DC648

STEEL DRUM FUSIBLE CLOSURES

Model No.	Size"	Torque req. (ft.-lbs.)
DB893	3/4	9
DB894	2	20

DB894

POLY-DRUM CLOSURES

Model No.	Size"	Threads
DB895	2	NPS
DB896	2	BSP

DB896



FORMFIT LINERS FOR 55-GALLON DRUMS

- Cylindrical film liners are heat-sealed and made of FDA compliant materials
- Available in 40" height to fold over drum or 53" height to tie off
- Available in mil thickness of 4, 8 or 10
- Available in anti-static for solvent-based applications



Model No.	Height"	Wall Thickness	Qty /Case
DC353	40	4 mil	100
DC354	40	8 mil	50
DC355	40	10 mil	50
DC494	40	6 mil	100
DC356	53	4 mil	100
DC495	53	6 mil	100
DC357	53	8 mil	50
DC358	53	10 mil	50
DC359*	53	8 mil	50

* Anti-static

ELASTICIZED DUST CAPS FOR 5, 30 & 55-GALLON CONTAINERS

- Clear 4-mil LDPE caps with elasticized band for easy installation
- Available in anti-static

Model No.	Drum Gallons
DC371	5
DC375*	5
DC372	30
DC376*	30
DC373	45
DC377*	45
DC496	64" Elastic Cover for Gaylord Box

* Anti-static



DRUM HEATERS

NEMA CONFIGURATION



NOTE: DO NOT USE THESE HEATERS IN HAZARDOUS AREAS OR TO HEAT FLAMMABLE MATERIALS. FOR INDOOR USE ONLY.

FLEXIBLE DRUM & PAIL HEATERS

APPLICATIONS

- Preheating • Viscosity control
- Mixing, dipping or pouring
- Temperature control • Freeze protection

FEATURES

- Durable and tough reinforced fiberglass silicone rubber
- Resists moisture, mildew and most chemicals
- Easy to clean and store
- Heavy-duty spring latch assembly, installs or removes in seconds
- 6' power cable w/ NEMA 5-15P plug for the 120 V models
- 6' bare end power cable for the 220 V models



Description	Drum Material	Thermostat range					
		70°-160°F		75°-205°F		75°-425°F	
		120 V	220 V	120 V	220 V	120 V	220 V
5 US GALLONS							
6" wide 300 W	Polyethylene	DC295	DC296	*	*	*	*
3" wide 300 W	Metal	DC297	DC298	DC299	DC300	DC301	DC302
15 US GALLONS							
6" wide 375 W	Polyethylene	DC303	DC304	*	*	*	*
3" wide 500 W	Metal	DC305	DC306	DC307	DC308	DC309	DC310
30 US GALLONS							
6" wide 500 W	Polyethylene	DC311	DC312	*	*	*	*
3" wide 750 W	Metal	DC313	DC314	DC315	DC316	DC317	DC318
55 US GALLONS							
6" wide 750 W	Polyethylene	DC319	DC320	*	*	*	*
3.25" wide 1000 W	Metal	DC321	DC322	DC323	DC324	DC325	DC326
4.75" wide 1500 W	Metal	DC327	DC328	DC329	DC330	DC331	DC332

* Polyethylene pails should not be heated beyond 160°F

THERMOSTAT CONTROL HEATERS

- Heats materials with good heat receptivity
- Made of aluminised steel; conjunction box made of galvanised steel
- Increases flow rate of viscous material
- Reaches and maintains a given temperature
- Thermostat bulb senses temperature and controls pre-set heat
- Three-heat switch allows three wattage ratings per thermostat setting
- HIGH setting uses Max. Watts; MEDIUM, 1/2 Max. Watts; LOW, 1/4 Max. Watts
- Neon pilot light
- 6' power cord



Model No.	Drum Cap. Gal.	Drum Dia. "	Temp Range	Plug Type NEMA no.	Volts	Watts	Wt. lbs.
DA072	55	22 1/2	60-250°F	5-15	120	1750	15
DA073	55	22 1/2	200-400°F	5-15	120	1750	15
DA092	55	22 1/2	60-250°F	5-20	120	1920	15
DA093	55	22 1/2	200-400°F	5-20	120	1920	15
DA094	55	22 1/2	60-250°F	6-15	240	3000	15
DA095	55	22 1/2	200-400°F	6-15	240	3000	15
DA090	5	11 1/4	60-250°F	5-15	120	1500	5
DA091	5	11 1/4	200-400°F	5-15	120	1500	5
DA087	16	14 1/2	60-250°F	5-15	120	1500	8
DA088	16	14 1/2	200-400°F	5-15	120	1500	8

WATER BOIL-OFF HEATERS

- For use with 55-gallon steel drums only
- Features a 70-300°F thermostat range and a high limit cut off-switch that can be reset
- When water is reduced below the level of the heater the unit shuts off
- Plug type is NEMA no. 6-15
- 240 V, 3000 W, 6' power cord
- Weight: 14 lbs.



Model No. DA096

5-GALLON PAIL HEATERS

- Economy 5-gallon heater is suitable for use with plastic and metal pails
- For light duty applications like increasing flow of viscous fluids or heating water
- Aluminised construction
- Adjustable strap clamp allows heater to fit pails with straight or tapered sides from 9 1/2" to 12" in diameter
- 120 V, 100 W
- 6' power cord with standard three pin grounded plug
- Weight: 0.5 lb



Model No. DA074

PLASTIC DRUM HEATERS

- Specifically designed to heat materials contained in polyethylene drums or pails
- Pre-set bimetal thermostat is mounted directly on heating band; activated with on-off switch
- Heat delivered to drum does not exceed 165°F
- 9" wide heating band on 55-gallon model is double the width of standard heaters; increases heater surface area for a shorter heat-up time
- On-off indicator light
- 6' power cord



Model No.	Drum Cap. Gal.	Drum Dia. "	Plug Type NEMA No.	Volts	Watts	Wt. lbs.
DA080	5	11 1/4	5-15	120	100	7
DA081	55	22 1/2	5-15	120	800	15

VARIABLE CYCLE CONTROL HEATERS

- Designed to heat materials that have a tendency to burn or cook such as light oils, chemicals, food, and undercoating material
- Variable control cycles heat current on and off
- Ratio of 'time on' to 'time off' increases as setting switch is moved higher
- Cycling allows for a gentle heating of drum contents
- Three heat switch allows three wattage ratings per thermostat setting
- HIGH setting uses Max. Watts; MEDIUM, 1/2 Max. Watts; LOW, 1/4 Max. Watts
- Neon pilot light
- 6' power cord



Model No.	Drum Cap. Gal.	Drum Dia. "	Plug Type NEMA no.	Volts	Watts	Wt. lbs.
DA084	5	11 1/4	5-15	120	1500	5
DA082	16	14 1/2	5-15	120	1500	8
DA085	55	22 1/2	5-20	120	1750	15
DA086	55	22 1/2	6-15	240	3000	15

VALUE HEATERS

- Sturdy aluminised steel construction outlasts and outperforms all silicone rubber heaters
- 0-550°F adjustable thermostat offers wide flexibility when heating contents of 55 gallon, 22 1/2" diameter steel drums
- Heavy-duty, 6' grounded cordset plugs into standard 120 V outlets, 1250 W
- Weight: 8 lbs.



Model No. DA070

BONDING & GROUNDING WIRES

Bonding and grounding wire assemblies dissipate the static electricity generated during the transfer of flammable liquids. Various clamp styles available to work with different containers. Required by OSHA for fluids with a flashpoint below 140°F.



HEAVY-DUTY BONDING & GROUNDING WIRE ASSEMBLIES

TWO HAND CLAMP CONNECTORS



Model No.	Wire Length"	Wire Description
DA735	36	Stainless Steel Cable
DA736	72	Stainless Steel Cable
DA737	120	Stainless Steel Cable

HAND CLAMP & 5/16" TERMINAL CONNECTORS



Model No.	Wire Length"	Wire Description
DA738	36	Stainless Steel Cable
DA739	72	Stainless Steel Cable
DA740	120	Stainless Steel Cable

LIGHT-DUTY BONDING & GROUNDING WIRE ASSEMBLIES

ALLIGATOR CLIP & 3/4" BEAM CLAMPS



Model No.	Wire Length"	Wire Description
DA621	36	Stainless Steel
DA750	72	Stainless Steel
DA751	120	Stainless Steel

TWO ALLIGATOR CLIPS



Model No.	Wire Length"	Wire Description
DA622	36	Stainless Steel
DA754	72	Stainless Steel
DA755	120	Stainless Steel
DA756	36	PVC Coated
DA757	72	PVC Coated
DA758	120	PVC Coated

ALLIGATOR CLIP & 5/16" TERMINAL CONNECTORS



Model No.	Wire Length"	Wire Description
DA759	36	Stainless Steel
DA760	72	Stainless Steel
DA761	120	Stainless Steel

COILED GROUNDING CLAMPS

- Vinyl coated 1/8" cable resists corrosive environments to give years of service
- Unit is self-coiling to retract when not in use
- Includes one heavy duty REB clamp and one 1/4" terminal end



Model No.	Description
DA632	5' coil
DA628	10' coil
DA777	15' coil
DB029	20' coil
DA778	30' coil

HEAVY-DUTY HAND CLAMPS

- Grounding clamp for flammable drum loading
- Die cast aluminum body, stainless steel points and 55-lbs. spring enable clamp to consistently make positive metal to metal ground connection
- Accommodates all cable up to 5/32"; connection is made in clamp's handle held by dual Allen screw contacts

Model No. DA633



HEAVY-DUTY STATIC GROUNDING HAND WIND REELS

- Ruggedly constructed reels are an economical alternative to automatic retracting reels
- Fewer parts to maintain, allowing for years of trouble free service
- Highly compact storage of a wide range of cable lengths
- 100A solid copper alligator clip can be substituted with our heavier duty REB clamp when using this reel in outdoor areas or with painted, dirty or rusty surfaces
- Cable Type: Yellow Hytrel coated plated steel



Model No.	Cord Length (feet)	Cable Size	Dimensions W" x D" x H"	Wt. lbs.
DC489	50	3/32" I.D. coated to 5/32" O.D.	9 1/5 x 5 3/10 x 9 7/10	9.8
DC490	75	3/32" I.D. coated to 5/32" O.D.	9 1/5 x 5 3/10 x 9 7/10	10.3
DC491	100	3/32" I.D. coated to 5/32" O.D.	9 1/5 x 5 3/10 x 9 7/10	10.8

RETRACTABLE GROUNDING WIRES

- Replace loose/tangled grounding cables with compact retractable reels
- For use where a discharge of static electricity could cause a spark and subsequent explosion
- Holds 20' to 100' of cable
- Positive latching mechanism holds cable at any length
- A slight pull on the cable releases the mechanism causing retraction
- Bearing surfaces are permanently lubricated
- Alligator clip included
- Heavy-duty reels have robust, weatherproof construction and coated cables
- Functions under extreme environmental conditions
- Available with REB clamp for when attaching clamp to painted, dirty or rusty surfaces



Model No.	Cable Description	Length'	Wt. lbs.
DA609	Light Duty	20	3.5
DA610	Light Duty	50	5.5
DB025	Heavy-Duty Open Style	50	12
DB026	Heavy-Duty Open Style	75	17
DB027	Heavy-Duty Open Style	100	22

STATIC GROUNDING CLAMPS

- Cast aluminum construction, available with stainless steel points or brass "cup" points
- Large, heavy-duty clamp designed for grounding railcars, tanker trucks, barges and large vats
- Equipped with a quick release harness, which is designed to open the clamp automatically in case the operator forgets to remove the clamp prior to the vehicle's departure
- Isolated points available for connection to static monitoring system
- Clamp opens to 1 1/2"

Model No.	Description	Configuration	Wt. lbs.
DC484	Stainless Steel Points	3 Points	0.7
DC485	Stainless Steel Points	1 Isolated Point	0.7
DC486	Brass Cup Points	1 Isolated Cup Point	0.7
DC487	Brass Cup Points	2 Isolated Cup Points	0.7



DRUM PUMPS

BEFORE ORDERING ANY PUMP, ESTABLISHING COMPATIBILITY WITH THE MSDS OF THE FLUID USED IN APPLICATION IS A MUST! BOND/GROUND CABLES ON PAGE B55 ARE REQUIRED WHEN PUMPING FLAMMABLE OR COMBUSTIBLE LIQUIDS.

ROTARY DRUM PUMPS

POLYPROPYLENE

- For most water-soluble inorganic acids, waxes, detergents
- Fits 15 to 55-gallon drums with a 2" bung adaptor
- Transfer rate: 8 oz. per revolution
- **Wetted components:** 304 stainless steel, polypropylene, PVDF, PTFE and Viton®

Model No. DB998



POLYPHENYLENE SULFIDE & STAINLESS STEEL

- Use with most aggressive chemicals such as hydrocarbons and ketones
- Fits 15 to 55-gallon drums with a 2" bung adaptor
- Transfer rate: 12 oz. per revolution
- **Wetted components:** 304 stainless steel, PVDF, polyphenylene sulfide and PTFE

Model No. DC335



#304 STAINLESS STEEL

- For most organic acids, alcohols and solvents
- Fits 15 to 55-gallon drums with a 2" bung adaptor
- Transfer rate: 12 oz. per revolution
- **Wetted components:** 304 stainless steel, PVDF and PTFE

Model No. DB759



PTFE

- For most aggressive chemicals such as acids and alkalines
- Fits 30 to 55-gallon drums with a 2" bung adaptor
- Transfer rate: 12 oz. per revolution
- **Wetted components:** Stainless steel, PVDF and PTFE

Model No. DB997



STEEL & CAST IRON

- For use with most medium viscosity petroleum fluid, light non-flammable and non-combustible fluids
- Dual directional operation allows pump to both empty and refill containers
- Fits 30 to 55-gallon drums with a 2" bung adaptor
- Transfer rate: 8 oz. per revolution
- **Wetted components:** Buna-N, cast iron, polyethylene, polypropylene and steel
- Steel discharge spout and polyethylene discharge hose of 1" diameter and 55" long included

Model No. DA528



DC098

Polyethylene discharge hose

ALUMINUM

- Use with most medium viscosity petroleum fluid, and non-corrosive fluids
- Fits 15 to 55-gallon drums with a 2" bung adaptor
- Transfer rate: 8 oz. per revolution
- **Wetted components:** Aluminum, Buna-N, polypropylene and steel

Model No. DC112



ALUMINUM

- Use with most low viscosity, non-corrosive petroleum based fluids and lubricating oils up to SAE30
- Fits 15 to 55-gallon drums with a 2" bung adaptor
- Transfer rate: 6.75 oz. per revolution
- Includes a safety locking latch
- 3/4" dia. x 1.8 m long PVC nitrile discharge hose included
- **Wetted components:** Aluminum, Buna-N, PVC nitrile, steel and zinc

Model No. DC126



ALUMINUM & CAST IRON

- FM approved pump with 8' antistatic hose, nozzle, flame arrestor and vacuum breaker
- For use with class 1 and class 2 flammable and combustible liquids such as gasoline, alcohols, and other solvents
- Fits 15 to 55-gallon drums with a 2" bung adaptor
- Transfer rate: 10 gallons per minute
- **Wetted components:** Cast iron, steel, graphite, polypropylene, aluminum, EPDM rubber and Buna-N

Model No. DC505



PVC PULL TYPE PUMPS

- For use with most mild acids, detergents, water and solvents
- Good insulation from spark and fire
- Adapts to 3/4" or 2" bung adaptor for 5 to 55-gallon drums
- Transfer rate: 8 oz. per stroke
- **Wetted components:** Polypropylene, polyethylene, PVC and silicone

Model No. DC116



NYLON PULL TYPE PUMPS

- For use with most lacquer thinners, mild acids, detergents, water and light viscosity petroleum liquids
- Fits 15 to 55-gallon drums with 2" bung adaptor
- Transfer rate: 14 oz. per stroke
- **Wetted components:** Polypropylene, nylon, 304 stainless steel and PTFE

Model No. DC128



DIAPHRAGM HAND PUMPS

- For petroleum fuels, light lubrication oils, and water-based solutions
- Fits 15 to 55-gallon drums with 2" bung adaptor
- Transfer Rate: 25.5 oz. per stroke
- Includes a safety locking latch
- **Wetted components:** Aluminum, Buna-N, Delrin®, 304 stainless steel and steel

Model No. DC068



TRANSFER PUMPS

- Non-corrosive, double action piston pump is designed to handle most petroleum products, solvents and industrial chemicals with viscosities up to 2000 SSU
- Discharges approx. 1 quart per stroke with a suction lift to 15'
- Thermoplastic constructed pump has a polyester glass reinforced body, Viton® "O" ring and cork-nitrile gasket
- All internal metal parts in contact with liquid are 316 stainless steel
- **Includes:** 8' PVC black vinyl discharge hose, 2-piece 1" x 34" L polyester suction tube, polyester discharge spout and 2" bung adaptor

Model No. DA526



STAINLESS STEEL PULL TYPE PUMPS

Model No. DA530

- Use with certain acids and alkalis
- Fits 5 to 55-gallon drums with a 2" bung adaptor
- Transfer rate: 8 oz. per stroke
- **Wetted components:** 304 stainless steel, brass, polyethylene and steel

Model No. DA531

- For most acids and corrosives
- Fits 5 to 55-gallon drums with a 2" bung adaptor
- Transfer rate: 8 oz. per stroke
- **Wetted components:** 304 stainless steel, 316 stainless steel, brass and PTFE

Model No. DA529

- For fast transfer of most acids and corrosives
- Fits 55-gallon drums with a 2" bung adaptor
- Transfer rate: 22 oz. per stroke
- **Wetted components:** 304 stainless steel, polyethylene and PTFE

Model No. DB845

- For fast transfer of most acids and corrosives
- Fits 55-gallon drum with a 2" bung adaptor
- Transfer rate: 22 oz. per stroke
- **Wetted components:** 304 stainless steel, 316 stainless steel and PTFE

KLETON



STEEL PULL TYPE PUMPS

Model No. DA527

- For most non-corrosive and non-flammable liquids
- Fits 5 to 55-gallon drums with a 2" bung adaptor
- Transfer rate: 8 oz. per stroke
- **Wetted components:** Brass, steel and polyethylene

Model No. DC113

- For most water-soluble inorganic acids, waxes, detergents
- Fits 5-gallon pails with a 2" bung adaptor
- Transfer rate: 8 oz. per stroke
- **Wetted components:** Buna-N, polyethylene, leather and steel

Model No. DC114

- Use with most non-corrosive, light to medium viscosity liquids
- Fits 55-gallon drums with a 2" bung adaptor
- 3/4" diameter spout can be rotated to 180° and removed to expose garden hose thread
- Transfer rate: 22 oz. per stroke
- **Wetted components:** Polyethylene, steel and zinc

KLETON



POLYPROPYLENE PULL TYPE PUMPS

Model No. DC127

- For use with most antifreeze, detergents, windshield fluids, glycerin, and mild acids
- Fits 15 to 55-gallon drums with 2" bung adaptor
- Transfer rate: 14 oz. per stroke
- **Wetted components:** Polypropylene, steel and Viton®

Model No. DC117

- For use with most corrosive chemicals, water, and non-flammable solvents
- Good insulation from spark and fire
- Fits 55-gallon drums with a 2" bung adaptor
- Transfer rate: 22 oz. per stroke
- **Wetted components:** Polyethylene, polypropylene and silicone

Model No. DC115

- For use with most corrosive chemicals and non-flammable solvents
- Fits 5 to 55-gallon drums with 3/4" or 2" bung adaptor
- 360° discharge spout orientation
- Transfer rate: 16 oz. per stroke
- **Wetted components:** Polyethylene, polypropylene, silicone and steel

Model No. DA532

- Use with most corrosive chemicals and non-flammable solvents
- Fits 5 to 55-gallon drums with 3/4" or 2" bung adaptor
- 360° discharge spout orientation
- Transfer rate: 8 oz. per stroke
- **Wetted components:** Polypropylene, polyethylene, silicone and steel

ENVIRO-WEDGE™

The Enviro-Wedge™ increases the amount of product pumped out of 25-45 gallon drums. When the drum is nearly empty tilt it on an angle and position the wedge under the drum. Continue pumping until flow stops. 100% recycled, rugged polyethylene construction. Wt. 1.5 lbs.

Model No. DA660



KLETON



DRUM PUMPS

BEFORE ORDERING ANY PUMP, ESTABLISHING COMPATIBILITY WITH THE MSDS OF THE FLUID USED IN APPLICATION IS A MUST! BOND/GROUND CABLES ON PAGE B55 ARE REQUIRED WHEN PUMPING FLAMMABLE OR COMBUSTIBLE LIQUIDS.

POLYPROPYLENE LEVER TYPE PUMP

- Use with certain water-based solvents, mild acids and light viscosity petroleum liquids
- Adapts to 1-1/2" or 2" bung adaptor for 5 to 55-gallon drums
- Transfer rate: 14 oz. per stroke

Model No. DC121

KLETON



POLYPHENYL SULFIDE LEVER TYPE PUMPS

- Use with most water-based solvents, strong acids or alkalis and light viscosity petroleum liquids
- Fits 5 to 55-gallon drums with a 1 1/2" or 2" bung adaptor
- Transfer rate: 14 oz. per stroke

Model No. DC122

KLETON



PTFE LEVER TYPE PUMPS

- Use with certain water-based solvents, strongest acids or alkaline solutions
- Fits 5 to 55-gallon drums with a 1 1/2" or 2" bung adaptor
- Transfer rate: 14 oz. per stroke

Model No. DC123

KLETON



STEEL LEVER TYPE PUMP

- Use with most dispensing and transferring non-corrosive and petroleum based fluids
- Cushioned vinyl grip handle
- Discharge spout can be rotated 180° and removed to expose gardenhose threaded outlet
- Adapts to 1-1/2" or 2" bung adaptor for 30 to 55-gallon drums
- Transfer rate: 11 oz. per stroke

Model No. DC124

KLETON



POLYPROPYLENE LEVER PUMPS

- Delivers approximately 10 ounces per stroke with a capability of 6 gallons per minute
- Manufactured of the highest quality polypropylene
- Will handle viscous materials equivalent to SAE #90 oil; also compatible with most acids, caustics and other mild liquids
- 2" bung adaptor and telescoping extension tube for use with 5 to 45-gallon drums
- 360° discharge spout orientation
- EPDM O-Rings

Model No. DA534



SAFETY PUMPS

- Constructed of highly polished carbon steel with Teflon® piston, packing and gasket for exceptional chemical and solvent resistance
- Steel pickup tube with internal screen keeps debris out of pump
- Pumps 8 oz. per stroke, designed to fit 55-gallon drums
- Comes complete with internal flame arrestor, steel bung adaptor to aid static grounding, and heavy duty bonding wires to remove hazardous static charge
- FM approved for handling flammables
- Also available in stainless steel for corrosive flammable liquids

Model No. DA513 Carbon Steel

Model No. DB831 Stainless Steel



PAIL TYPE PUMPS

- Use with most engine oils, gear oils, and antifreeze
- Fits 5 gallon drums with a 2 1/4" bung adaptor
- Includes a 48" discharge hose fitted with curved metal spout at discharge end
- Transfer rate: 2 oz. per stroke

Model No. DC129

KLETON



POLYETHYLENE SIPHON PUMPS

- Use with most water based liquids, light oils and detergents
- Air vent in handle controls flow
- Fits 15 to 55-gallon drums with 2" bung adaptor
- Transfer rate: 7 gallons/minute

Model No. DC119

KLETON

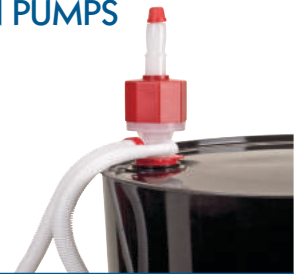

ACID TRANSFER PUMPS

- Designed to transfer most acids
- Body and shaft are constructed of a special polyvinyl chloride with the valves and patented seal of DuPont's Viton®
- Intake tube is 38" long and 1 1/2" dia.
- Flow rate is 28 oz. per stroke
- Complete with 3' polyethylene discharge tubing

Warning: Not compatible with most alkalis, acetic acid (30%), hydrofluoric acid and methyl alcohol

BECKSON

Model No. Adaptor Style
DA810 Std. 2" IPS Bung



ALKALI TRANSFER PUMPS

- Designed to transfer detergents, waxes, alkalis and certain acids
- Body and shaft are constructed of a special polyvinyl chloride with the valves and seals of DuPont's Hypalon®
- Intake tube is 38" long and 1 1/2" dia.
- Flow rate is 28 oz. per stroke
- Compatible with most alkalis, hydrofluoric acid, acetic acid (30%) and methyl alcohol
- Complete with 3' polyethylene discharge tubing

BECKSON

Model No. Adaptor Style
DA811 Std. 2" IPS Bung



PETROLEUM DRUM PUMPS

- Designed to transfer petroleum products
- Body and shaft are constructed of a special polyvinyl chloride with valves of polyurethane, seals of Buna-N and a reinforced vinyl hose
- Intake tube is 38" long and 1 1/2" dia.
- Flow rate is 28 oz. per stroke
- Compatible with petroleum products
- Complete with 3' vinyl discharge tubing

BECKSON

Model No. Adaptor Style
DA812 Std. 2" IPS Bung



BEFORE ORDERING ANY PUMP, ESTABLISHING COMPATIBILITY WITH THE MSDS OF THE FLUID USED IN APPLICATION IS A MUST! BOND/GROUND CABLES ON PAGE B55 ARE REQUIRED WHEN PUMPING FLAMMABLE OR COMBUSTIBLE LIQUIDS.

DRUM ACCESSORIES

MANUAL-CLOSING MOLASSES GATE VALVES

- Excellent for dispensing heavy oils, light grease, varnish, molasses, honey, cream and other non-flammable heavy viscous fluids from drums and containers
- All gates have 45-60° discharge for optimum flow control
- Durable cast iron body, painted black enamel finish
- Machined and lapped brass faceplate for smooth operation and perfect seal
- Can be padlocked in sizes up to and including 2"

Model No.	NPT Inlet Size"	Wt. lbs.
STANDARD GATE WITH 2" HANDLE		
DA059	3/4	1.5
DA060	1	2.0
DA061	1 1/4	2.4
DA062	1 1/2	2.9
DA063	2	3.2
DA057	3	6.8
DA058	4	15.5

Model No.	NPT Inlet Size"	Wt. lbs.
STANDARD GATE WITH 4" HANDLE		
DA055	1 1/2	4.3
DA056	2	4.6
DA054	3	7.7
GATE VALVE WITH LOCK NUT, 2" HANDLE		
DA051	3/4	1.6
DA052	1 1/2	3.2
DA053	2	3.6



Note: These faucets are intended for use with non-flammable viscous liquids stored in or dispensed from non-pressurized containers at ambient room temperature.

SELF-CLOSING FAUCETS

- For non-flammable liquids only
- No flame arrestor
- 3/4" pipe thread
- Can be padlocked closed
- Natural zinc die cast finish

Model No. PE365



SELF-CLOSING FAUCETS W/SCREEN

- For use with flammable and non-flammable liquids
- Flame arrestor safety faucet
- Standard 3/4" tapered pipe thread
- Can be padlocked closed
- Natural zinc die cast finish

Model No. PE364



MANUAL-CLOSING POLY FAUCETS

- Ideal for use with non-flammable, often corrosive liquids
- Half turn on/off; stays open until shut-off
- Use 2" size for thick, viscous liquids or larger volume flow of thin liquid



Model No.	Bung"	Wt. lbs.
DA048	2	0.50
DA049	3/4	0.08

FAUCETS

- Approved for use with oils and non-flammables compatible with stainless steel
- Internal flame arrestor
- Teflon® gasket, 3/4" NPT connection
- FM approved



Model No.	Description	Wt. lbs.
DC404	Rigid Brass	0.5
DA043	Stainless Steel	2.00

VERTICAL DRUM GAUGES

- Graduated in gallons, litres, quarters and eighths full
- Heavy steel and plastic construction with leak proof duronitrile gaskets
- Resistant to oil and many chemicals
- Available for 3/4" or 2" NPT bung opening
- Weight: 1 lbs.



Model No.	Bung"
DA069	3/4
DA068	2

GRADUATED DRUM GAUGES

- Constructed of heavy gauge glass in plated steel body with Buna-N seals
- Excellent for most oils, solvents and chemicals
- Combination gauge and faucet permits uninterrupted draining of drum contents with gauge in place
- Mounts through 3/4" bung hole
- Weight: 3 lbs.



Model No.	Description
DA064	Gauge Only
DA065*	Gauge with Faucet

* Zinc die cast faucet FM approved for viscous liquids only; no flame arrestor.

HORIZONTAL BRASS VENTS

- Horizontal vents are for use with drums in the horizontal pouring position
- Automatically relieves pressure at 5 PSI
- Flame arrestor prevents sparks and flame from igniting contents
- Manual vacuum relief by lifting and rotating the valve stem
- Maximum flow of 220 CFM at 20 PSI
- Fits 2" NPS bung in steel or plastic drums

Model No. PE362



SELF CLOSING GATE VALVES

- For use with viscous non-corrosive fluids heavier than SAE30 motor oil
- Heavy-duty brass construction
- Self-closing PTFE blade has fast, positive shut off when handle is released
- 4 1/2" wide handle
- Wide opening permits maximum flow
- Fits 2" bung in steel or plastic drums
- Weight: 7 lbs.

Model No. PE363



VERTICAL VENTS

FM approved vents are for use with drums in the upright position. Valve automatically opens to relieve internal pressure at 5 PSI. Automatic vacuum relief permits 4 GPM flow through 3/4" faucet. Fits 2" NPT bung opening.



Model No.	Description	Application	Wt. lbs.
DA607	Brass Vent	Petroleum-Based	0.5
DA605	Non-metallic Vent, Cad-plated flame arrestor	Petroleum-Based	0.5
DA606	Non-metallic Vent, Stainless steel flame arrestor	Chlorinated Solvents	1.0

DRUM FILL GAUGES

- When drum is almost full, indicator "pops up" to warn you
- Fits in standard 3/4" bung opening
- Length: 5"
- Bright red and yellow molded polyethylene
- Weight: 0.2 oz.
- FM approved

Model No. DA066
Mfg. No. 8530



DRUM ACCESSORIES

DRUMS-UP™ TRAYS

THE INCIDENTAL SPILL SOLUTION!

- Catch liquid before it reaches the floor, reducing the risk of slip and fall injuries
- Ideal for use as a drum pumping station
- Secondary containment unit features a unique geometric design covering more floor area
- Drain hole makes emptying easy

DRUMS-UP™

- Contains drips for containers up to 55 US gallons
- Control nuisance spills from drums with a 20 US gallon capacity
- Convenient pour spout

DRUMS-UP JR™

- Containment for 16 to 30 US gallon drums and 5-gallon pails
- 7 1/2 US gallon capacity



DA104

Drum or pail not included



SD361



Model No.	Mfg. No.	Description	Dimensions			Wt. lbs.
			Dia."	x	H"	
DA104	8091-YE	Drums-Up™	34	x	7 1/4	12
SD361	8200-YE	Drums-Up Jr.™	22 3/4	x	7 1/2	4

SAFETY DRUM FUNNELS

- Suitable for handling flammables, minimise potentially dangerous spills
- Large 10 3/4" mouth provides quick dumping
- Steel construction with 6" flame arrestor for the DA102 and 32" flame arrestor for the DA101
- Hinged cover with fusible link reduces spread of vapours
- 2" NPS/NPT
- FM approved



Model No.	Mfg. No.	Flame Arrestor"	Wt. lbs.
DA102	8207	6	11
DA101	8205	32	29

PROTECTIVE 55-GALLON DRUM LIDS

- Tough average 40-mil thick LDPE lids protect steel drum tops from corrosion and contamination
- Available for open head and tight head drums
- Available in clear to view labelling on drum top



Model No.	Description
DA116	Open Head Drum, Black Lid
DA117	Open Head Drum, Clear Lid
DA118	Tight Head Drum, Black Lid
DA119	Tight Head Drum, Clear Lid

UNIVERSAL POLY-DRUM FUNNEL™

- Patented scalloped design, high sidewall and bung fitting holders
- For use with 30 and 55 US gallon drums
- Funnels nest for compact shipment
- Safety funnel includes a non-sparking safety bung closure with flame arrestor for use with flammable liquids
- Optional cover keeps the weather out
- Dimensions: **Exterior** - 26" dia. x 5 1/2" H; **Interior** - 22" dia. x 4" H

SAH566

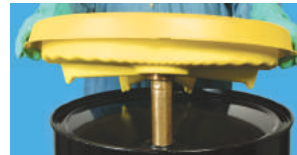

SAH567/SAH565

Model No.	Mfg. No.	Description	Wt. lbs.
SAH565	3004-4E	Funnel	3
SAH566	3004-YE-SF	Safety Funnel	5
SAH567	3040-YE	Funnel Cover	3



SAFETY FUNNELS WITH VENT

- Provides safe waste solvent disposal due to automatic pressure and vacuum relief
- 9" diameter polyethylene funnel comes with brass safety vent and 6" flame arrestor
- Cap comes with safety chain to prevent loss
- 2" NPS/NPT
- FM approved
- Wt.: 4 lbs.

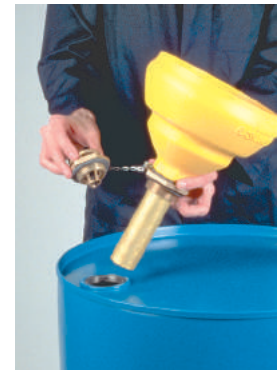

Model No. DA103 Mfg. No. 8211



CEASE-FIRE® ASHTRAYS - ALUMINUM HEADS

- Specially designed contoured head directs smoke and gas from any fire inside the container back into the combustion area
- Air supply is limited and flames are extinguished in seconds
- FM approved, corrosion-free aluminum heads provide easy clean-up and can be used with standard steel drums



Model No.	Description	Wt. lbs.
NI418	For 30-Gallon Receptacle	2.9
NI419	For 55-Gallon Receptacle	4.3

FUSIBLE LINK SELF-CLOSING DRUM COVERS

- Convert open top 55 US gallon steel drums into fire-safe receptacles for combustible trash
- A replaceable fusible link assembly inside the cover melts at 165°F, automatically slamming the cover shut if a fire occurs in the drum
- Steel construction; solvent resistant, red baked-on-enamel finish
- Fits drums from 22 1/2" to 22 3/4" in diameter
- FM approved

Model No. DA097



BUNG NUT WRENCHES

- Fits almost any metal or plastic, male or female bung nuts or plugs
- 13" overall length
- Offset handle
- Weight: 4 lbs.

Model No. DA638
Annealed Ductile Iron

Model No. DA637
Non-Sparking,
Manganese Bronze Alloy

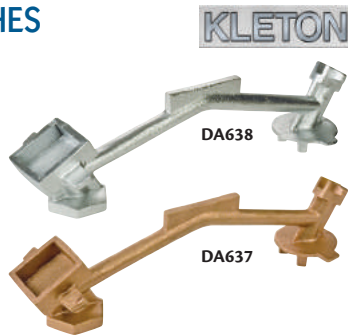

UNIVERSAL PLUG WRENCHES

- Fits virtually all steel, plastic and fibre drum plugs
- 15 1/2" long for extra leverage and hand clearance
- For use with 3/4" and 2" pipe thread (NPT) size bungs
- Weight: 4 lbs.

Model No. DA635
Solid Ductile Iron

Model No. DA636
Non-Sparking, Zinc Aluminum Alloy

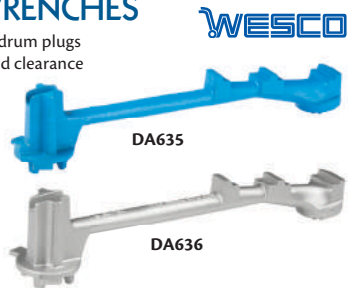

DRUM WRENCHES

- Socket head which fits over 3/4" plugs and prongs that fit the crossbar of 2" plugs
- Fits other types of closures too

Socket Head - 2.0 lbs.

Model No. DA643
Mfg. No. W0168

Non Sparking - 2.5 lbs.

Model No. DA647
Mfg. No. W0168S

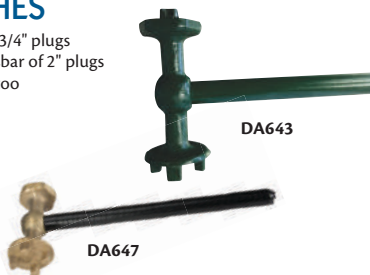

DELUXE PLUG WRENCHES

- Non-sparking brass alloy wrench fits virtually all industrial drums including those with square or hex plugs, male or female bung nuts or plugs and fittings with lugs and crossbars
- Built-in 1 1/4" wrench for tightening faucets into drums; eliminates the need for extra tools
- Weight: 2 lbs.

Model No. PE359



DRUM LOCKS

- Safely secure drum contents without the risk of contamination
- Reduces theft, pilfering, sabotage and prevents "cocktailing" of contents
- Made of corrosion resistant, non-sparking zinc die cast, the units easily install around the drum bung flange with no risk of cross threading
- Sold as a pair, these drum locks fit the most popular style of steel 55-gallon (200 L) drums
- Set includes 2 lip seals and 2 interchangeable lock bars

Both sets are available without or with a No.3 Master Lock® padlock



Model No.	Description	Size Lip Seal O.D.
DC282	Without Lock	1 x 3", 1 x 1 1/2"
DC289	With Keyed Different	1 x 3", 1 x 1 1/2"
DC291	With Keyed Alike	1 x 3", 1 x 1 1/2"



DRUM UPENDERS

- This 40" long upender provides the necessary leverage for moving horizontal drums to a standing position
- 2 1/2" wide toe plate prevents denting of drum
- 1 1/2" hook fits over most drum heads
- Weight: 12 lbs.



Model No. DA653



MANUAL DRUM DEHEADER

- Open any size and gauge steel drum quickly and easily, allowing drum recycling without the risk of fire from cutting with a torch
- Comfortable plastic hand grip
- Frame Material: Steel
- Blade Material: Steel
- Handle Length: 20"

Model No. DC603 Drum Deheader

Model No. DC607 Replacement Blade



PAIL PALS

- Designed to open and close virtually any type of steel or plastic pail
- Cast steel construction for durability
- Yellow zinc-plated finish with molded blue plastic hand grip
- Includes a special cutting tool to open sealed lids on plastic pails
- Weight: 2 lbs.

Model No. DC041



PLASTIC PAIL OPENERS

- Ideal for opening non-UN plastic buckets and pails
- Unique leverage point ends cover distortion and cutting
- Holds pail down while it lifts lid evenly; lid lifts off in seconds
- Aluminum construction
- 16" long
- Weight: 0.5 lbs.

Model No. DA639



DRUM BUNG SOCKET

- Fits 3/4" and 2" bung sizes



DC665



DC666



Model No.	Mfg No.	Description
DC665	BUNG-S-B1	3/8" Drive, Non-Sparking Bronze Alloy
DC666	BUNG-S-S1	3/8" Drive, Zinc-Plated Drum Socket
DC667	BUNG-S-S2	1/2" Drive, Zinc-Plated Drum Socket
DC668	BUNG-S	3/4" Drive, Zinc-Plated Drum Socket

DRUM TRUCKS

DRUM HAND TRUCKS

- All welded, 1 1/4" round tubular steel frame
- Handles steel drums from as small as 18" to 25" in diameter
- Ideal for loading drums onto pallets, or for going over curbs or uneven docks
- Free standing when loaded
- Capacity: 1000 lbs.
- Durable Kleton blue enamel finish



DA594



Model No.	Description	Overall Dim. W" x D" x H"	Wt. lbs.
DA593	w/10" Front Rubber Wheels Only	24 x 19 x 58	44
DA594	w/10" Front and 6" Rear Rubber Wheels	24 x 22 x 58	50

DRUM HAND TRUCKS FOR PLASTIC & FIBRE DRUMS

- All welded, 1 1/4" round tubular steel frame
- Handles plastic and fibre drums from 18" to 25" in diameter and 24" to 41" in height
- Rolls on 10" front and 6" rear rubber-tired wheels
- 2" ratchet strap secures drum in place
- Dimensions: 23" W x 24" D x 58" H
- Weight: 56 lbs. • Capacity: 1000 lbs.
- Durable Kleton blue enamel finish



Model No. DA595



ALL-IN-ONE DRUM TRUCKS

- All welded, 1 1/4" round tubular steel frame
- Drum trucks can be used to transport and dispense drums
- Easy-to-use belt-system and hook keeps drums securely on the truck
- Easy to load and unload on skids
- Handles plastic, steel or fibre drums
- Loop handle models provide added leverage while dual handle models provide side body comfort
- Four wheel design for added support and easy manoeuvrability
- Capacity: 1200 lbs.
- Durable Kleton blue enamel finish



Retaining hook



DC266



Model No.	Handle Type	Wheel Type	Wt. lbs.
DC266	Loop	10" Mold-On Rubber	64
DC267	Loop	10" Pneumatic	58
DC256	Dual	10" Mold-On Rubber	62
DC257	Dual	10" Pneumatic	56



DC256

ERGONOMIC DRUM TRUCK WITH SWIVEL CASTERS

- Rear swivel casters permit greater lateral manoeuvrability, allowing truck to pivot about its axis
- Especially useful in a restricted space, ie. When unloading drums from a truck or in a crowded warehouse
- Provides four-wheel support while transporting drum and steering truck
- 10" Mold-On rubber wheels and 6" Mold-On rubber swivel casters
- Drum Capacity: 55 - 85 US Gal. (45 - 70 Imperial Gal.)
- Capacity: 1000 lbs.

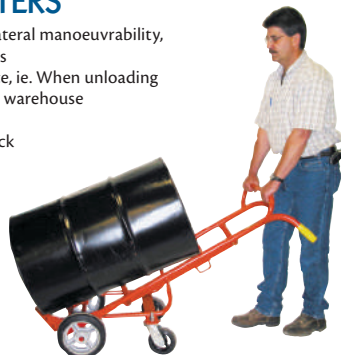

Model No. DA864
Mfg No. 240121



ERGONOMIC DRUM TRUCKS

- Floating axle reduces effort required to break over and balance load
- Chime hook can be stored at the top of the frame for easy use
- Replaceable hard faced double beveled nose prongs
- Handles steel drums only
- 10" mold-on rubber wheels
- Overall dimensions: 17 1/2" L x 23 3/4" W x 61" H
- Capacity: 1000 lbs.
- Weight: 74 lbs.

Model No. DC417



SINGLE BAR DRUM TRUCKS

- Handles 45 imp. gal./55 US gallon steel drums
- Heavy-duty 1" structural pipe frame with double welded joints
- Machined steel load wheels behind nose prongs help ease lifting of drum
- Classic single bar frame design
- Kickstand and vinyl handle grips included
- Available with cast iron centre Mold-On rubber wheels with 1" (ID) roller bearings or polyolefin wheels
- 24" wide at handle, 16 1/4" wide at nose
- Capacity: 1000 lbs.



Model No.	Wheel Type	Wt. lbs.
DA883	Polyolefin	50
DA882	Mold-On Rubber	64



OVERPACK DRUM TRUCK

- Heavy duty, double-welded joints, 1" structural pipe frame
- Self standing or with kick stand for upright storage
- Recommended primarily for handling of overpacks
- Wide "feet" eliminate the risk of drums being punctured by nose prongs
- Floating axle reduces effort required to break over and balance load
- Drum Capacity: 30 - 85 US Gal. (25 - 70 Imperial Gal.)
- Overall Dimensions: 24" W x 24" D x 59-3/4" H
- Load Capacity: 1000 lbs.
- Handles: Poly, Overpack Drums

Model No. DC624
Mfg No. 240077



DRUM SPOTTERS

- Moves drums to and from pallets easily across floors, effectively and efficiently
- Designed for 45 imp. gal./55 US gallon steel or plastic drums with various rims and most fibre drums with clamp-on lids in a size range of 22" to 23 1/2" diameter and 34 to 36" high, weighing up to 800 lbs.
- Features two forged lifting hooks which slide under the top rim of drum
- Handle provides adequate leverage to lift heavy drums
- Base has built-in counterweight for stability
- Features two 6" polyolefin load wheels and two 4" rear swivel caster for easy steering

Features:

- Simple to operate
- Compact
- Holds drums upright
- No power truck required
- Self-supporting
- No balancing required

Model No.	Lifting Capacity lbs.	Max. Pallet Height"	Wt. lbs.
DA933	800	6	145



ALL-WELDED DRUM ROCKERS

- Safe method of upending up to 45 imp. gal./55 US gal. drums for moving, draining or storing
- All welded, 1 1/4 round tubular steel frame
- No lifting, straining, or danger of drum tipping backwards
- Removable handle
- Two 3" polyolefin wheels and two swivel casters
- Capacity: 1000 lbs.
- Durable Kleton blue enamel finish



Model No.	Overall Dimensions W" x D" x H"	Wt. lbs.
DC442	33 x 22 x 20	38

KNOCKED-DOWN DRUM ROCKERS

- Safe method for moving, draining and storing 45 imp. gal./55 US gal. drums
- Two 3" non-sparking wheels and two 3" non-sparking swivel casters
- Removable handle
- Capacity: 700 lbs.
- Powder coat finish
- Shipped knocked down



Model No. DC443



MOBILE DRUM CARRIERS

- Transports, rotates, tilts and drains fully loaded drums up to 800 lbs.
- Drum can be raised to a floor clearance of 5 1/8" to 11 1/2", automatically sets lock
- Tilt lock on each side of unit
- All-welded steel construction; 8" polyolefin wheels and 4" swivel caster
- Weight: 106 lbs.



Model No.	Drum
DA189	45 imp. gal./55 US gallon Steel; 22 1/2" Dia.
DA190	45 imp. gal./55 US gallon Plastic and Steel; 22 1/2" - 24" Dia., 34" - 36" H
DA191	25 and 45 imp. gal./55 US gallon Steel; 18 1/2" - 19" and - 22 1/2" Dia.
DA192	21" - 23" Dia. Fibre and Steel
DA193	25 and 45 imp. gal./55 US gallon Fibre and Steel; 18 1/2" - 19" and - 22 1/2" Dia.

LIL'DOLLY™ PAIL DOLLIES

- Designed for use in hospitals, food processing plants, manufacturing locations, hotels, restaurants and anywhere 5, 6 and 15-gallon pails are used
- Five dual wheel swivel stem casters
- Inside diameter: 11"
- Capacity: 75 lbs.
- Weight: 2 lbs.

Model No. MD527



LOW PROFILE DRUM TRUCKS

- All-welded steel construction with 8" x 2" rubber wheels and a 4" non-marking rubber swivel caster for smooth movement and easy manoeuvrability
- Ideal for moving full, open top 45 imp. gal./55 US gal. drums without spilling contents
- With a low-level frame, only 1/2" from the ground, this truck allows for easy loading of drums
- Hinged handle moves forward and backward for easy pushing or pulling
- Capacity: 1000 lbs.
- Quality powder coat finish
- Shipped knocked down



Model No.	Overall Dimensions W" x D" x H"	Overall Handle Length"	Wt. lbs.
DC500	30 x 24 x 46	39	44

STEEL DRUM DOLLIES

- Welded 3/16" thick x 4", frames are built to withstand constant use
- 24" inside diameter handles 45 imp. gal./55 US gal. drums
- Comes with four swivel casters
- Quality powder-coat finish
- Caster assembly required

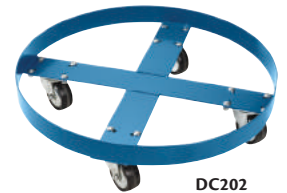

Model No.	Caster Type	Caster"	Height"	Capacity lbs.	Wt. lbs.
ROUND FRAME					
DC202	Polyolefin	3	4 1/2	750	21
DC199	Polyurethane	3	4 1/2	1000	24
DC200	Polyurethane	4	5 1/2	1500	27
DC070*	Frame Only	-	-	-	16
X-FRAME					
DC206	Polyolefin	3	4 1/2	750	13
DC203	Polyurethane	3	4 1/2	1000	16
DC204	Polyurethane	4	5 1/2	1500	19
DC071*	Frame Only	-	-	-	8

* Fits Caster Hole Spacings of 1 5/8" x 3" to 2 3/4" x 3 1/4"

CLAMP & GO DOLLY HANDLES

- Safely and easily maneuver drum within confined areas
- Perfect for high volume applications
- Low center of gravity provides superior stability
- Quickly clamps onto dollies with various sidewalls of 2", 2 1/2" or 3"
- Foot operated disengage
- Magnet holds handle up to drum for compact storage
- Weight: 11 lbs.



Model No. DC414



LEAK CONTAINMENT DRUM DOLLY

- Polyethylene dolly will not dent, corrode or rust
- Handles 30 imp. gal./37 US gal. & 45 imp. gal./55 US gal. drums
- Solid bottom construction with a 2" lip contains spills up to 5 L
- Overall diameter: 24 1/4"
- Capacity: 1000 lbs.
- Grey



Model No.	Caster Type	Caster"	Height"
DC465	Polyurethane	3	6 1/4
DC466	Polyolefin	3	6 1/2
DC467	Polyolefin	4	7 1/4

DRUM LIFTERS

DRUM & OVERPACK LIFTER

- Drum Lifter is designed to lift and transport a standard 55 US Gal. steel drum 22.5" in diameter
- Drum lifter can also lift an 85 US Gal. overpack or salvage drum 26" in diameter
- Drum lifter can be used on closed "tight" head drums type with head intact, or with open head drums with lid securely clamped in place
- The broad faced grippers spread holding force to minimize pressure on drum
- Unit is load tested at the factory at 125% of rated capacity as per ASME B30.20
- Lifting Capacity: 1000 lbs./454 kg

Model No. DC608
Mfg No. 91



DRUM LIFTER

- Universal drum lift can lift 30 US gal. to 85 US gal. drums
- Lifts steel or plastic drums 18"-26" in diameter
- Lifts fibre drums 18.5"-23" rim diameter
- Not intended for use with plastic overpack drums
- Lifting Capacity: 1000 lbs./454 kg.

Model No. DA876
Mfg No. 92

STAINLESS STEEL

Model No. DC094
Mfg No. 92-55



DRUM LIFTERS

- Designed for steel, plastic and fibre drums with diameters between 22" to 23-1/2" and heights between 23" to 38"
- Attaches to a monorail, crane or chain block and transports loaded drums in the upright position
- The drum is secured into the saddle by a pawl and ratchet mechanism
- The saddle, as well as the support bar at the bottom of the drum ensure that drums will be transported safely, restraining the drum from sliding out
- Accepts diameter adaptors for smaller drums
- Drum Capacity: 30 - 55 US Gal. (25 - 45 Imperial Gal.)
- Lifting Capacity: 1000 lbs./454 kg

Model No. DA935
Mfg No. 86

DA935



TYPE 304 STAINLESS STEEL

Model No. DC644
Mfg No. 86-55

POLYESTER DRUM SLING

- Securely and economically lifts steel, plastic and fibre drums from 12" to 24" in diameter
- Ideal for use with a forklift truck
- Compact size of slings allows it to be stored in truck until it's needed
- Reduces drum damage which occurs when using steel handlers
- 2" x 10' endless ratchet strap tightens the reinforced polyester lifting belt around the body of the drum
- 4" x 6' double ply tie down web slips easily over the truck forks
- Capacity: 1000 lbs.
- Wt.: 5 lbs.

Model No. DC470

Note: Open ratchet fully when installing sling



HORIZONTAL DRUM LIFTING HOOKS

- Horizontally lifts 45 imp. gal./55 US gal. steel drums, 34"-36" long
- Alloy steel lifting ring, steel rods, malleable iron hooks
- Capacity: 1000 lbs.
- Weight: 5 lbs.

Model No. DC449

- Spark resistant lifting hook is made of bronze and stainless steel for safe handling
- Capacity: 1000 lbs.
- Weight: 5 lbs.

Model No. DA163



DA163



DC449

MULTI-PURPOSE OVERHEAD DRUM LIFTERS WITH WRENCHES

- Simple three-arm design allows for safe lifting of closed head 30 to 45 imp. gal./55 US gallon steel, plastic, and fibre drums with top lips
- Each removable arm also functions as a wrench for use on different drum plugs, faucets, and rim ring bolts.
- Lifts drums up to 800-lb. capacity
- Powder coat finish for durability
- Weight: 19 lbs.

Model No. DC095

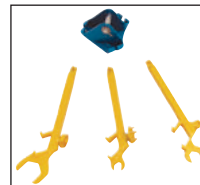

AUTO-GRIP DRUM LIFTERS

- Easy, no-tilt lifting of rimmed steel drums
- Self-energizing: the heavier the load, the tighter the grip
- Attaches to any hoist, crane or forklift using single fork hook attachment
- Heavy-duty, annealed, ductile iron construction
- Large curved foot at bottom of stabilising arm prevents drum damage
- Capacity: 3000 lbs.
- Wt.: 31 lbs.

Model No. DA226



DRUM LIFTERS

- Quick and easy attachment and removal
- Suitable for use with standard steel or poly drums with at least a 3/16" chime
- Lifting arms are adjustable to work with most 55 or 30-gallon drums
- Attaches to any hoist, crane or forklift using single fork hook attachment
- 3-point contact of the lifting arms minimizes deformation
- Also works on closed head drums
- Capacity: 1000 lbs.
- Weight: 15.5 lbs.

Model No. DC420



DRUM LIFTERS & HANDLERS

STEEL DRUM GRABBERS

- Lift and transport one 45 imp. gal./55 US gal. steel drum without the fork truck driver leaving his seat
- No risk of drum slipping since handler grips under rim of drum or rolling hoops
- Heavy gauge grabber slides onto truck forks and is locked with two turn down screws



Model No.	Description	Fork Pocket Inner Dia.,"	Capacity lbs/Drum	Wt. lbs.
DC424	Single Drum Grabber	5 1/2" x 2"	1000	121

STEEL DRUM GRABBERS

- Lift and transport one or two 45 imp. gal./55 US gal. steel drums without the fork truck driver leaving his seat
- No risk of drum slipping since handler grips under rim of drum or rolling hoops
- Heavy gauge grabber slides onto truck forks and is locked with two turn down screws



Model No.	Description	Fork Pocket Inner Dia.,"	Capacity lbs/Drum	Wt. lbs.
DC039	Double Drum Grabber	7" x 2 1/4"	1000	198

GRAVITY-ACTUATED MECHANICAL AUTO-GRIP™

- Most efficient on consistently-sized loads
- Adjusts to grasp any cylindrical object 18"-28" D (DA175)/22"-24" D (DC014)
- Spring-and-cam actuated jaws automatically grip while engaging drum
- Jaw size: 3" x 15"
- Fork tube size is 1 5/8" x 5 5/8" x 20"
- Distance between forks is 19 1/2"

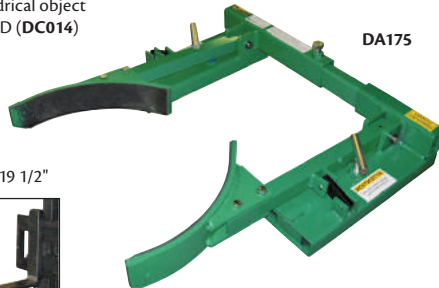

Model No.	Drum Type	Drum Size US Gal.	Capacity lbs.
DA175	Steel, Plastic, Overpack	30-85	1500
DC014	Plastic Only	55	1000

FORK MOUNT HOOK

- A fork mounted hook from which to suspend a drum lifter or other device
- Fork Pocket Dimensions: 5-1/2" x 1-9/16"
- Capacity: 2000 lbs.

Model No. LU639

MORSE



POLY DRUM LIFTERS

- Patented fork truck attachment for handling most 45 imp. gal./55 US gal. and 30 US gallon poly drums
- Fork truck driver does not have to leave cab to engage or disengage drum
- Suited for poly drums that have at least a 3/16" top lip (chime)
- Fork pocket size: inside 1 1/2" x 5 3/8"
- Capacity: 1000 lbs.
- Shipped knocked down

Model No. DA932
Mfg No. 240148



WESCO

GATOR GRIP™ FORKLIFT ATTACHMENTS FOR DRUM HANDLING

- Handles steel, plastic and fibre drums
- Patented auto grip lock automatically locks the jaws closed, even over rough terrain
- Adjustable for 30, 50 and 80 US gallon drums
- T-handles fasten safety to any forklift
- Can be used with open or closed head drums
- Capacity: 1000 lbs. per grip

Applications: Shipping, receiving, loading, racking and palletizing



WESCO

Model No.	Description	Overall Dimensions W" x D" x H"	Wt. lbs.
DC268	Single Drum Handler	28" x 34" x 34"	126
DC269	Dual Drum Handler	33 1/4" x 34" x 34"	208

DRUM LIFTERS & HANDLERS

GATOR GRIP™ ERGONOMIC DRUM HANDLERS

- Handles steel, plastic and fiber drums
- Patented Auto Grip™ lock automatically locks the jaws closed, even over rough terrain
- Ergonomic solution for lifting, transporting and placing drums on standard pallets or spill pallets
- The jaw clamp is spring loaded and can hold any 3/16" or higher drum rim
- Adjustable for most standard 30, 55 and 85 gallon drums
- Allows a 55 gallon drum to be raised 20" above the floor
- Rolls smoothly on swivel casters which provide easy steering and include a floor lock
- Overall dimensions: 34 1/2" L x 36" W (legs retracted), 37" L x 41" W (legs extended)
- Capacity: 1100 lbs.
- Weight: 356 lbs.

Model No. DC270
Mfg No. 240150



FORK MOUNTED DRUM LIFTERS

- Allows operator to raise, transport, tip and drain loaded drums without leaving their seat
- Geared design with pull chain or battery powered with pendant for controlled dispensing of open and closed head steel drums up to 2000 lbs.
- Manipulation of pull chain on geared type models for 360° rotation
- Attaches easily to truck by sliding onto forks and tightening screw locks
- No electrical or hydraulic connections to truck are needed
- 6 1/2" W x 26 5/8" D x 2 1/12" H fork pockets; inside width between truck forks must be at least 25"
- Options are available to handle plastic, fibre, and steel drums
- 22 1/2" diameter

Model No.	Mfg No.	Drum Size Gallons	Tilt Type	Full Drum Cap. lbs.	Half Drum Cap. lbs.	Wt. lbs.
DA133	285A	45 Imp. /55 US ¹	Geared	800	500	149
DA135	285A-HD	45 Imp. /55 US	Geared	1500	800	171
DA134	285A-GR	45 Imp. /55 US	Geared	2000	1000	273

Note: Battery powered option available



DA133
Controlled pouring up to 2000 lbs.



DRUM LIFTERS

Safely transport, position and drain open and closed head steel drums. Simply attach the lifter on hook of chain block, monorail or crane, cinch saddle around drum, and then raise to the required height and position. Ratchet mechanism securely tightens saddle to drum. Choice of manual or geared models.

MANUAL TILT

- Ideal for low level pouring and dumping operations
- 800 lbs. full drum capacity, 500 lbs. half drum capacity
- Tilt lock on each side of hanger frame is used to secure drum in a vertical or horizontal position

Model No.	Mfg No.	Drum Size
DA199	85A	45 imp. gal./55 US gal. steel; 22 1/2" dia.
DA200	85i & 55/30-19	25 and 45 imp. gal./55 US gal. steel; 18 1/2" - 19" and 22 1/2" dia. Includes DC280
DA201	85C	21" - 23" dia. fibre or steel

Note: Options and accessories are available

GEARED TILT

- Accurate pouring from any height
- Handles drums up to 2000 lbs full drum capacity
- Rotation of drum is controlled by 12' chain loop
- Optional MORStop™ tilt brake holds drum tilt position constant even when tension from the pull chain is removed



Model No.	Mfg No.	Drum Size	Full Drum Cap. lbs.	Half Full Cap. lbs.	Wt. lbs.
DA121*	185A	45 imp. gal./55 US gal. steel; 22" - 23 1/2" dia.	800	500	86
DA124*	185A-HD	45 imp. gal./55 US gal. steel; 22 1/2" dia.	1500	800	109
DA123**	185A-GR	45 imp. gal./55 US gal.; 22 1/2" dia.	2000	1000	177

OPTION

DC077	3900-P	MORStop™ Tilt Brake Option
-------	--------	----------------------------

* Chains can be guided into locking slots to hold the drum's position, allowing the operator to let go

** Worm gear speed reducer on DA123 tends to let drum stay where it is stopped, removing the need for the optional tilt brake



DA199



DA124



DRUM HANDLERS & RACKS

DRUM STACKING RACKS

- Rack holds two or three 45 imp. gal./55 US gal. drums
- Can be stacked up to three high
- Conveniently stacks drums horizontally increasing space efficiency
- Forklift access from all four sides
- Optional mobile units available
- Shipped knocked down



KLETON

Drums not included

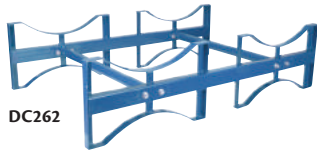

DC262



Model No.	Drum Cap.	O.A. Dimensions W" x D" x H"	Max Capacity lbs. *	Wt. lbs.
DC262	2	45 1/2 x 30 x 12 1/2	1600	48
DC263	3	71 1/2 x 30 x 12 1/2	2400	75

*The total weight capacity for all drums and racks being stacked.

DRUM STACKING RACK & DOLLY KITS

- All welded, ready to use
- Dolly allows stacking racks to be mobile
- Two rigid and two swivel casters
- Durable Kleton blue enamel finish
- Caster assembly required



DC386
Drip Pan and Faucet
Not Included

KLETON

Model No.	Wheel Type	Overall Dimensions W" x D" x H"	Capacity lbs.
DC386	6" Hi-Temp Nylon	46 x 30 x 21 1/2	1600
DC387	6" Polyurethane	46 x 30 x 21 1/2	1600

CAN TIPPERS

- Handles 5-gallon round pails
- Safety lever holds container in place
- Dispensing height of 11-1/2"
- Capacity: 75 lbs
- Weight: 10 lbs

Model No. DC472

KLETON



PORTABLE DRUM STANDS

- Designed for compact storage of 30 and 55-gallon steel and fibre drums
- Interlocking design secures stand to drum
- Enclosed fork tubes lock stand onto forks and allow for secure transportation of drums with fork or pallet truck
- Allows drums to be stacked three high
- Powder coated safety yellow for visibility
- 1500-lb. maximum capacity per stand
- Weight: 35 lbs.

Model No. DC073

Vestil
www.vestil.com



GRIP+GO POWER-GRIP FORK MOUNT DRUM HANDLER

- Control the drum tilt function all the way from upright to fully inverted
- The grip pressure is adjustable for handling a steel, plastic, or fiber drum
- The battery and charger are included
- The sufficiently low weight of the Grip+Go helps for a minimal lost load of your equipment
- Engage drum with heavy-duty jaws
- Use with the wireless control for a 300 foot operating range (DC679)
- Easy to handle various sized drums
- Drum Capacity: 15 - 55 US Gal. (12.5 - 45 Imperial Gal.)
- Working Load Limit: 1500 lbs./680 kg
- Battery Type: 12V
- Drum sizes: 14" to 24" diameter

Model No. DC678
Mfg No. 290F

GRIP+GO FACTORY INSTALLED
WIRELESS CONTROL ON MODEL 290F

Model No. DC679
Mfg No. 6149i-P

MORSE



DRUM TUMBLR™

- Mix ingredients right inside a sealed drum
- Remix settled ingredients without inserting anything into your drum
- Can be used to rotate plastic, fibre and steel drums
- Save the labour of transferring contents and clean-up
- Improve safety: Eliminate spills, contamination, and exposure to contents
- Drum Size Capacity: 55 US gal. (45 Imperial Gal.)
- Comply with OSHA requirements with a Morse guard enclosure sold separately
- Add a Morse Control Panel Package for variable speed from 2-20 RPM (not included)
- Rotate a drum "corner-over-corner" to thoroughly mix drum contents
- Capacity: 800 lbs. (363 kg) full drum, 400 lbs. (181 kg) half-full drum
- Motor Voltage: 230 V/460 V
- Motor HP: 1 HP
- No. of Drums: 1
- Hertz: 60 Hz
- Motor Style: Inverter-Duty

Model No. LU055
Mfg No. 309-3



DRUM TUMBLR™ CONTROL
PANEL PACKAGE 115V

- For use with Morse Drum Tumbler® 309-3
- Includes wire terminals for external connection of safety interlock switch
- Complies with OSHA requirements with a Morse guard enclosure sold separately
- Timer adjusts from a few seconds to 16 hours
- Equipped with a Start and Stop and a Red emergency stop button
- Drum Speed: 2 to 20 RPM
- Power Supply: 24 V DC

Model No. LU056
Mfg No. CP-309-1-115



DRUM TUMBLR™ SAFETY
ENCLOSURE

Model No. LU057
Mfg No. GEK-309-3



FIBREGLASS LADDERS

WHAT HEIGHT?

STEPLADDER

Max. Height You Want to Reach*	Buy This Size
7'	4'
8'	5'
9'	6'
10'	7'
11'	8'
12'	10'
14'	12'
16'	14'
18'	16'
20'	18'
22', 24'	20'

*Assumes a 5' 6" person with a vertical 12" reach

EXTENSION LADDER

Height of Top Support Point	Buy This Size*
9' max.	16'
9' to 13'	20'
13' to 17'	24'
17' to 21'	28'
21' to 25'	32'
25' to 28'	36'
28' to 31'	40'

*Reflects section overlap, ladder angle

WHAT LOAD CAPACITY?

Formula:

Your Weight + Material Weight = Load Capacity

Typically Add:
 75 lbs. For Heavy-Duty Projects
 50 lbs. For Light-Duty Projects

200 lbs.	CSA Grade 3 Household
225 lbs.	CSA Grade 2 Tradesman and Farm
250 lbs.	CSA Grade 1 Construction and Industrial
300 lbs.	CSA Grade 1A Construction and Industrial meets ANSI Type I, Industrial Heavy Duty
375 lbs.	CSA Grade 1AA Construction and Industrial meets ANSI Type IAA, Extra Heavy-Duty

INDUSTRIAL-DUTY FIBREGLASS STEPLADDERS (6300 SERIES)

CSA Grade 1, ANSI Type 1, 250-lb. Load Rating

- Durable non-conductive "C" channel front rails in high visibility safety orange
- Super tough copolymer utility top for strength and durability
- Wide 3" slip-resistant serrated aluminum steps for safe climbing
- Rugged outside zinc-coated steel spreader arms
- Rear horizontal struts every 12", top and bottom struts reinforced with zinc-coated steel diagonal braces
- Heavy-duty slip-resistant safety shoes

VC025



FEATHERLITE INDUSTRIAL LADDERS

Model No.	Nominal Height'	Open Height"	Highest Standing Height"	Base Width"	Base Depth"	Approx Weight lbs.
VC023	4	46	23	20	30	17
VC024	5	57	34	21	34	18
VC025	6	68	45	23	43	20
VC026	7	79	56	24	44	23
VC027	8	90	67	26	55	26

INDUSTRIAL HEAVY-DUTY FIBREGLASS STEPLADDERS (6900 SERIES)

CSA Grade 1A, ANSI Type 1A, 300-lb. Load Rating

- Durable non-conductive "C" channel side rails in high visibility safety yellow
- Super tough copolymer utility top
- Wide 3" slip-resistant serrated aluminum steps for safe climbing
- Inside spreader arms
- Full rear "L" horizontal struts every 12"
- Reinforced with zinc-coated steel diagonal braces at top and bottom steps
- Extra-large PVC rubber safety boots are heavy-duty and provide rail protection and slip-resistance

MF609



FEATHERLITE INDUSTRIAL LADDERS

Model No.	Nominal Height'	Open Height"	Highest Standing Height"	Base Width"	Base Depth"	Approx Weight lbs.
MF606	3	34	11	19	23	12
MF607	4	45	23	20	28	14
MF608	5	56	34	21	34	17
MF609	6	68	45	23	39	20
MF610	7	79	56	24	44	23
MF611	8	90	67	26	51	26
MF612	10	113	90	29	61	37
MF613	12	137	114	32	74	48

INDUSTRIAL HEAVY-DUTY FIBREGLASS STEPLADDERS (6400 SERIES)

CSA Grade 1A, ANSI Type 1A, 300-lb. Load Rating

- Durable non-conductive "C" channel side rails in high visibility safety yellow
- Super tough copolymer top for strength and durability
- Slip-resistant serrated aluminum steps
- Inside spreader arms complete with "wraparound" brackets to strengthen spreader to rail connection
- Full rear "L" horizontal struts every 12", top and bottom struts reinforced with zinc-coated steel diagonal braces
- Extra-large PVC rubber safety boots are heavy-duty and provide increased rail protection and slip-resistance

MD490



FEATHERLITE INDUSTRIAL LADDERS

Model No.	Nominal Height'	Open Height"	Highest Standing Height"	Base Width"	Base Depth"	Approx Weight lbs.
VC211	2	24	11	17	17	8
MD487	3	34	11	19	23	12
MD488	4	46	23	20	28	15
MD489	5	57	34	21	34	19
MD490	6	68	45	23	39	23
MF516	7	79	56	24	44	27
MD491	8	90	67	26	50	30
MD492	10	113	90	29	61	38
MD493	12	137	114	32	74	52

INDUSTRIAL EXTRA HEAVY-DUTY FIBREGLASS STEPLADDERS (6800 AA SERIES)

CSA Grade 1AA, ANSI Type 1AA, 375-lb. Load Rating

- Extra strong non-conductive "C" channel side rails in high visibility safety orange
- Super tough copolymer top for strength and durability
- Wide 3" slip-resistant serrated aluminum steps for safe climbing
- Inside spreader arms complete with "wraparound" sleeves that strengthen spreader-to-rail connection and protect spreader arms during storage/loading/transit
- Each step is double braced with zinc-coated steel diagonal braces providing incredible strength and stiffness
- Full rear "L" horizontal struts reinforced with zinc-coated steel diagonal braces offer maximum rigidity
- Heavy-duty aluminum "wraparound" sleeves at base of rails for maximum protection

VC256



FEATHERLITE INDUSTRIAL LADDERS

Model No.	Nominal Height'	Open Height"	Highest Standing Height"	Base Width"	Base Depth"	Approx Weight lbs.
VC254	4	46	23	20	28	15
VC255	5	57	34	21	34	19
VC256	6	68	45	23	39	27
VC257	7	79	56	24	45	31
VC258	8	90	67	25	50	35
VC259	10	113	90	29	61	44
VC260	12	136	113	31	72	59

FIBREGLASS LADDERS

INDUSTRIAL HEAVY-DUTY FIBREGLASS PLATFORM STEPLADDERS (6500 SERIES)

CSA Grade 1A, ANSI Type 1A, 300-lb. Load Rating

- Durable non-conductive "C" channel side rails in high visibility safety yellow
- Large safe and comfortable standing platform, 14" x 18"
- Wide 3" slip-resistant serrated aluminum steps for safe climbing
- Rugged outside zinc-coated steel spreader arms
- Each step reinforced with zinc-coated steel diagonal braces providing strength and stiffness
- Rear horizontal struts reinforced with zinc-coated steel braces offer maximum rigidity
- Heavy-duty slip-resistant safety shoes



MF411

FEATHERLITE
INDUSTRIAL LADDERS

Model No.	Nominal Height'	Open Height"	Highest Standing Height"	Base Width"	Base Depth"	Approx Weight lbs.
VC205	4	46	24	21	30	17
VC206	5	57	35	23	36	22
MF411	6	68	46	24	42	25
MF412	8	90	68	26	53	33
MF413	10	113	92	29	67	41
VC207	12	135	115	31	75	50

INDUSTRIAL EXTRA HEAVY-DUTY FIBREGLASS PLATFORM STEPLADDERS (6500 AA SERIES)

CSA Grade 1AA, ANSI Type 1AA, 375-lb Load Rating

- Extra strong non-conductive "C" channel side rails in high visibility safety yellow
- Large safe and comfortable standing platform, 14" x 18"
- Wide 3" slip-resistant serrated aluminum steps for safe climbing
- Heavy duty aluminum "wraparound" sleeves at base of rails
- Rugged outside zinc-coated steel spreader arms
- Each step reinforced with zinc-coated steel diagonal braces providing strength and stiffness



VC225

FEATHERLITE
INDUSTRIAL LADDERS

Model No.	Nominal Height'	Open Height"	Highest Standing Height"	Base Width"	Base Depth"	Approx Weight lbs.
VC223	4	46	24	20	38	24
VC224	5	57	35	22	47	28
VC225	6	68	46	23	56	32
VC226	8	90	68	26	72	48
VC227	10	113	92	29	91	57
VC228	12	135	115	32	109	66

INDUSTRIAL HEAVY-DUTY FIBREGLASS 2-WAY STEPLADDERS (6600 SERIES)

CSA Grade 1A, ANSI Type 1A, 300-lb. Load Rating

- Double front construction allows two climbers to access the ladder from opposite sides
- Durable non-conductive "C" channel side rails in high visibility safety yellow
- Wide aluminum top with extra-thick brackets for strength and durability
- Wide 3" slip-resistant serrated aluminum steps for safe climbing
- Inside spreader arms complete with "wraparound" sleeves that strengthen spreader-to-rail connection and protect spreader arms during storage/loading/transit
- Reinforced with zinc-coated steel diagonal braces on the front of every other step providing extra rigidity
- Extra-large PVC rubber safety boots are heavy-duty and provide rail protection and slip-resistance



MF414

FEATHERLITE
INDUSTRIAL LADDERS

Model No.	Nominal Height'	Open Height"	Highest Standing Height"	Base Width"	Base Depth"	Approx Weight lbs.
VC214	4	45	23	20	38	19
VC461	5	57	34	22	49	25
MF414	6	67	45	23	56	26
VC462	7	79	56	25	65	36
MF415	8	90	67	26	72	36
MF416	10	112	89	29	91	46
VC215	12	135	112	32	109	58

INDUSTRIAL EXTRA HEAVY-DUTY FIBREGLASS 2-WAY STEPLADDERS (6600 AA SERIES)

CSA Grade 1A, ANSI Type 1AA, 375-lb. Load Rating

- Extra strong non-conductive "C" channel side rails in high visibility safety orange
- Double front construction allows access from either side
- Extra strength fiberglass side rails in high visibility safety yellow
- Redesigned super-tough top bracket system for even greater stability
- Slip-resistant 3" aluminum steps
- Heavy-duty aluminum "wraparound" sleeves at base of rails



VC219

FEATHERLITE
INDUSTRIAL LADDERS

Model No.	Nominal Height'	Open Height"	Highest Standing Height"	Base Width"	Base Depth"	Approx Weight lbs.
VC218	4	45	23	20	38	19
VC219	6	67	45	23	56	26
VC220	8	90	67	26	72	36
VC221	10	112	89	29	91	46
VC222	12	135	112	32	109	58

SAFETY DO'S

Care & Maintenance

- Inspect the rails of fiberglass ladders for weathering due to UV (ultraviolet) exposure
- Keep the ladder protected from heat, weather, and corrosive materials



Safety Before You Climb

- Use fiberglass ladders if there is even a remote possibility of working near electricity or overhead power lines. Fiberglass is electrically non-conductive
- NEVER use metal, water logged or dirty wood ladders near electricity!



FIBREGLASS LADDERS

INDUSTRIAL HEAVY-DUTY FIBREGLASS PRO PLATFORM STEPLADDERS (FXP1700 SERIES)

CSA Grade 1A, ANSI Type 1A, 300-lb. Load Rating

- Super tough copolymer utility top includes multiple tool slots
- Durable non-conductive "C" channel side rails in high visibility safety orange
- Platform dimensions: 14 3/4" W x 21" D
- Utility top is 30" above the platform
- Wide 3" slip-resistant serrated aluminum steps for safe climbing
- Heavy-duty slip-resistant safety shoes
- Rugged outside zinc-coated steel spreader arms



VD407



Model No.	Nominal Height'	Open Height"	Highest Standing Point"	Base Width"	Base Depth"	Approx. Weight lbs.
VD405	4 1/2	53 1/4	24	21 1/4	32 5/8	18
VD406	5 1/2	64 5/8	36	23 1/3	38 5/8	22
VD407	6 1/2	76	48	24 4/5	44 4/7	24
VD408	7 1/2	87 1/2	60	26 1/5	50 1/2	27
VD409	8 1/2	97 7/8	72	27 3/4	56 4/9	30
VD410	10 1/2	121 3/4	96	30 7/8	68 1/4	46
VD411	12 1/2	144 1/2	120	33 4/5	80 1/8	60
VD412	14 1/2	167 1/2	144	36 4/5	92	72

INDUSTRIAL EXTRA HEAVY-DUTY FIBREGLASS PRO PLATFORM STEPLADDERS (FXP1800 SERIES)

CSA Grade 1AA, ANSI Type 1AA, 375-lb. Load Rating

- Super tough copolymer utility top includes multiple tool slots
- Durable non-conductive "C" channel side rails in high visibility safety orange
- Platform dimensions: 14 3/4" W x 21" D
- Utility top is 3' above the platform
- Wide 3" slip-resistant serrated aluminum steps for safe climbing
- Heavy-duty slip-resistant safety shoes
- Rugged outside zinc-coated steel spreader arms



VD413



Model No.	Nominal Height'	Open Height"	Highest Standing Point"	Base Width"	Base Depth"	Wt. lbs.
VD413	5	57 5/8	24	21 1/4	32 5/8	19
VD414	6	69 1/8	36	23 1/3	38 5/8	23
VD415	7	80 1/2	48	24 4/5	44 4/7	25
VD416	8	91 7/8	60	26 1/5	50 1/2	28
VD417	9	103 3/8	72	27 3/4	56 4/9	31
VD418	11	127	96	30 7/8	68 1/4	47
VD419	13	149	120	33 4/5	80 1/8	61
VD420	15	172 3/8	144	36 4/5	92	73

INDUSTRIAL HEAVY-DUTY FIBREGLASS 2-WAY PLATFORM STEPLADDERS (FMP1500 SERIES)

CSA Grade 1A, ANSI Type 1A, 300-lb. Load Rating

- Durable non-conductive "C" channel side rails in high visibility safety orange
- Platform dimensions: 14 2/5" W x 17 1/10" D
- Top rail guard height is 21" above platform
- Wide 3" slip-resistant serrated aluminum steps for safe climbing
- Heavy-duty slip-resistant safety shoes
- Double-rivet step construction
- Rugged outside zinc-coated steel spreader arms



VD428



Model No.	Nominal Height'	Open Height"	Highest Standing Point"	Base Width"	Base Depth"	Wt. lbs.
VD428	6	67 7/8	48	25 3/8	53 3/8	35
VD421	8	96	72	28 3/8	69 1/2	56
VD373	10	114 1/8	96	31 3/8	85	77
VD372	12	113 7/8	120	34 3/8	100 1/4	98

EXTRA WIDE HEAVY-DUTY INDUSTRIAL FIBREGLASS PLATFORM STEPLADDERS (6500-XW SERIES)

CSA Grade 1A, ANSI Type 1A, 300-lb. Load Rating

- Durable non-conductive "C" channel side rails in high visibility safety yellow
- Large, safe and comfortable slip-resistant platform, 24" W x 18" D
- 3" wide slip-resistant serrated aluminum steps for safe climbing
- Rugged outside zinc-coated steel spreader arms
- Heavy-duty aluminum "wrap around" sleeves at base of rails
- Each step reinforced with zinc-coated steel diagonal braces providing strength and stiffness
- Rear horizontal struts reinforced with zinc coated steel brace offer maximum rigidity
- Heavy-duty slip resistant safety boots



VC721



Model No.	Nominal Height'	Open Height"	Platform Height"	Base Width"	Base Depth"	Wt. lbs.
VC719	4	46	23	25	36	18
VC720	5	57	34	27	42	22
VC721	6	68	46	28	48	27
VC722	8	90	68	30	59	31

INDUSTRIAL HEAVY-DUTY FIBREGLASS EXTENSION LADDERS (6900 SERIES)

CSA Grade 1A, ANSI Type 1A, 300-lb. Load Rating

- Durable non-conductive fiberglass side rails in high visibility safety yellow
- Rung through rail design
- Slip-resistant serrated "D" rungs for safe climbing and comfort
- Black ABS, high impact non-marring end caps
- Large heavy-duty pivot feet with slip-resistant rubber pads and ice picks



VC329



Model No.	Nominal Height'	Max. Open Height'	Base Section		Fly Section		Wt. lbs.
			Outside Width"	Inside Width"	Outside Width"	Inside Width"	
VC329	16	13	17 1/8	14 3/4	16 1/8	13 3/4	34
VC330	20	17	17 1/8	14 3/4	16 1/8	13 3/4	43
VC331	24	21	17 1/8	14 3/4	16 1/8	13 3/4	51
VC332	28	25	17 1/8	14 3/4	16 1/8	13 3/4	58
VC333	32	28	17 1/8	14 3/4	16 1/8	13 3/4	65

INDUSTRIAL EXTRA HEAVY-DUTY STRAIGHT LADDERS (5600 SERIES)

CSA Grade 1AA, ANSI Type 1AA, 375-lb. Load Rating

- Durable non-conductive fiberglass side rails in high visibility safety yellow
- Riveted rung to rail design maintains continuous strength of fibres and allows for easy repair
- Slip-resistant serrated rungs for safe climbing
- Black ABS, high impact non-marring end caps
- Feature large heavy-duty pivot feet with slip-resistant rubber pads and ice picks



VC263



Round Rung Model No.	"D" Rung Model No.	Nominal Height'	Outside Width"	Inside Width"	Approx. Weight lbs.
VC263	VC268	8	17 3/8	15	18
VC264	VC269	10	17 3/8	15	21
VC265	VC270	12	17 3/8	15	24
VC266	VC271	14	17 3/8	15	28
VC267	VC272	16	17 3/8	15	31

ALUMINUM LADDERS

INDUSTRIAL HEAVY-DUTY ALUMINUM STEPLADDERS (3400 SERIES)

- CSA Grade 1A, ANSI Type 1A, 300-lb. Load Rating.**
- High strength to weight ratio provides an economical alternative for general contract work
 - Super tough copolymer top for strength and durability
 - Wide slip-resistant serrated aluminum steps for safe climbing
 - Rugged outside zinc-coated steel spreader arms
 - 10" x 10" heavy-duty hinged utility tray for holding tools and paint accessories
 - Heavy-duty slip-resistant safety shoes



FEATHERLITE
INDUSTRIAL LADDERS

Model No.	Nominal Height'	Open Height"	Highest Standing Point"	Base Width"	Base Depth"	Wt. lbs.
VC241	4	46	23	18	29	12
VC242	5	57	34	20	35	14
VC243	6	68	45	21	41	17
VC244	8	91	67	24	54	22
VC245	10	114	90	26	66	28
VC315	12	135	114	32	78	40
VC316	14	158	134	35	88	51
VC317	16	181	160	38	102	59

INDUSTRIAL HEAVY-DUTY ALUMINUM PLATFORM STEPLADDERS (3500 SERIES)

- CSA Grade 1A, ANSI Type 1, 300-lb. Load Rating.**
- Ideal for general fixed height work
 - Large comfortable slip-resistant platform, 14" x 18"
 - Wide slip-resistant serrated aluminum steps for safe climbing
 - Outside spreader arms
 - Heavy-duty slip-resistant safety shoes



FEATHERLITE
INDUSTRIAL LADDERS

Model No.	Nominal Height'	Open Height"	Platform Height"	Base Width"	Base Depth"	Wt. lbs.
MF069	4	46	23	21	28	13
VC460	5	56	34	22	33	17
VC246	6	68	46	24	42	19
VC247	8	90	68	26	54	24
VC248	10	114	92	29	66	30
VC312	12	135	115	34	78	43
VC313	14	157	136	36	87	52
VC314	16	180	158	39	102	60

COMMERCIAL-DUTY ALUMINUM STEPLADDERS (2400 SERIES)

- CSA Grade 2, ANSI Type 2, 225-lb. Load Rating**
- Super tough molded copolymer utility top
 - Durable yet light-weight extruded side rails
 - 3" slip-resistant serrated steps
 - J-shaped spreader arms
 - Heavy-duty rubber safety shoes



FEATHERLITE
INDUSTRIAL LADDERS

Model No.	Nominal Height'	Open Height"	Highest Standing Height"	Base Width"	Base Depth"	Wt. lbs.
MF063	4	45	24	18	31	9
MF064	6	67	45	21	44	13
VC458	7	79	57	24	50	18
MF065	8	90	67	25	56	19
VC459	10	114	92	28	69	26

INDUSTRIAL HEAVY-DUTY 2-WAY STEPLADDERS (3600 SERIES)

- CSA Grade 1A, ANSI Type 1A, 300-lb. Load Rating**
- Double-front construction allows access from either side
 - Serrated steps and side rails
 - Features extra thick top brackets for greater stability and heavy-duty rubber safety shoes



FEATHERLITE
INDUSTRIAL LADDERS

Model No.	Nominal Height'	Base Width"	Spread"	Wt. lbs.
VC318	4	19	39	14
VC319	6	21	57	20
VC320	8	24	72	28
VC321	10	26	89	36

INDUSTRIAL HEAVY-DUTY ALUMINUM EXTENSION & STRAIGHT LADDERS

- CSA Grade 1A, ANSI Type 1A, 300-lb. Load Rating**
- Heavy-duty "C" channel construction
 - Side rails: 2 1/2" x 1" for straights up to 14'
 - Side rails: 3" x 1" for straights up to 16' and up
 - Heavy-duty serrated "D" rungs prevent slipping for safe and sure climbing
 - Black ABS, high impact, non-marking end caps
 - Heavy-duty safety shoes

Model No.	Nominal Length'	Working Length'	Outside Width"	Wt. lbs.
SINGLE LADDERS (3100D SERIES)				
VC273	8	-	17 3/4	12
VC274	10	-	17 3/4	14
VC275	12	-	17 3/4	18
VC276	14	-	17 3/4	21
VC277	16	-	17 3/4	24
VC278	18	-	17 3/4	27
VC279	20	-	17 3/4	30

Model No.	Nominal Length'	Working Length'	Outside Width"	Wt. lbs.
EXTENSION LADDERS (3200D SERIES)				
VC322	16	13	17 3/4	31
VC323	20	17	17 3/4	36
VC324	24	21	17 3/4	43
VC325	28	25	17 3/4	51
VC326	32	29	17 3/4	58
VC327	36	32	17 3/4	69



FEATHERLITE
INDUSTRIAL LADDERS

SAFETY DON'T'S

- DON'T stand above the highest **safe standing level**
- DON'T stand above the second step from the top of a stepladder and the 4th rung from the top of an extension ladder. A person standing higher may lose their balance and fall



ALUMINUM LADDERS

4 TO 1 RATIO

Place an extension ladder at a 75 1/2° angle. The set-back ("S") needs to be 1 ft. for each 4 ft. of length ("L") to the upper support point.

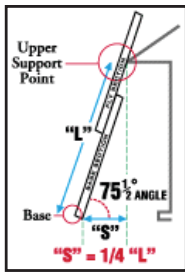

SAFETY DO'S

- Climb facing the ladder. Center your body between the rails. Maintain a firm grip
- Always move one step at a time, firmly setting one foot before moving the other
- Haul materials up on a line rather than carry them up an extension ladder
- Use extra caution when carrying anything on a ladder

SAFETY DON'T'S

- DON'T place the base of an extension ladder too close to the building as it may tip over backward
- DON'T place the base of an extension ladder too far away from the building, as it may slip out at the bottom. **Set the ladder at a 75 1/2° angle**
- DON'T over-reach, lean to one side, or try to move a ladder while on it. You could lose your balance or tip the ladder. **Climb down and then reposition the ladder closer to your work!**



INDUSTRIAL HEAVY-DUTY ALUMINUM EXTENSION /STRAIGHT LADDERS

CSA Grade 1A, ANSI Type 1A, 300-lb. Load Rating

- Rigid box section side rails, unequalled for strength and durability
- Side-mounted rope pulley and slide guide system keeps rope clear of climbers feet and allows easy raising (only on extension)
- Yellow ABS, high impact non-marring end caps
- Premium heavy-duty rung locks (only on extension)
- Slip-resistant serrated "D" rungs for safe climbing and comfort (round rung on single)
- Heavy-duty ribbed swivel feet with ice picks



FEATHERLITE
INDUSTRIAL LADDERS

Model No.	Nominal Length'	Working Length'	Width"	Wt. lbs.
SINGLE LADDERS (4100 SERIES)				
MD506	8	-	14 5/8	13
MD507	10	-	14 5/8	16
MD508	12	-	14 5/8	19
MD509	14	-	14 5/8	22
MD510	16	-	14 5/8	25
MD511	18	-	14 5/8	28
MD512	20	-	14 5/8	31
EXTENSION LADDERS (4200D SERIES)				
VC033	16	13	17	29
VC034	20	17	17	37
VC035	24	21	17	44
VC036	28	25	17	50
VC037	32	29	18 1/2	69
VC038	36	32	18 1/2	78

MULTI-PURPOSE JAWS™ TELESCOPIC LADDERS

CSA Grade 1A, ANSI Type 1A, 300-lb. Load Rating

- Compact and multifunctional, replaces all conventional ladders
- Easily folds for storage or transport
- Flared ends with slip-resistant feet provide superior stability in any position
- Polymer rung locks are virtually indestructible
- Welded outer rungs
- Extra deep side rails make the Jaws™ stiffer and stronger
- Mechanical interlocking tooth hinges for superior strength and five locking positions
- Extruded 6061-T6 marine alloy for strength and corrosion resistance
- JLT Series has extra-strong "Box-beam" rails for maximum strength and durability

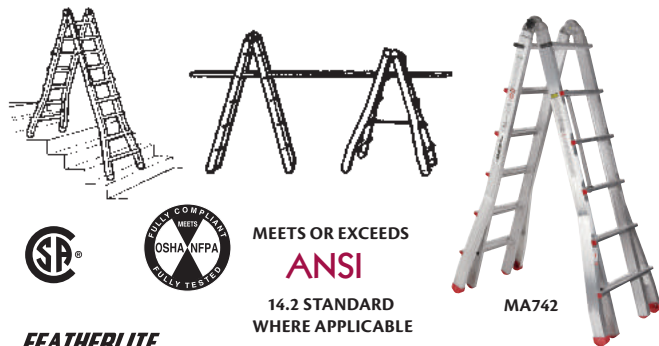

MEETS OR EXCEEDS
ANSI
14.2 STANDARD
WHERE APPLICABLE

FEATHERLITE
INDUSTRIAL LADDERS

Model No.	Folded Height	Extension Range'	Stepladder Range'	Scaffold Height'	Wt. lbs.
MA740	4' 9"	9 to 15	4 1/2 to 7 1/2	1 to 4	36
MA741	5' 9"	11 to 19	5 1/2 to 9 1/2	1 to 5	41
MA742	6' 9"	13 to 23	6 1/2 to 11 1/2	1 to 6	50

EXTRA WIDE HEAVY-DUTY INDUSTRIAL ALUMINUM PLATFORM STEPLADDERS (3500-XW SERIES)

CSA Grade 1A, ANSI Type 1A, 300-lb. Load Rating

- Large, safe and comfortable slip-resistant platform, 24" W x 18" D
- 3" wide slip-resistant serrated aluminum steps for safe climbing
- Rugged outside zinc-coated steel spreader arms
- Heavy-duty slip-resistant safety boots



FEATHERLITE
INDUSTRIAL LADDERS

Model No.	Nominal Height'	Open Height"	Platform Height"	Base Width"	Base Depth"	Wt. lbs.
VC709	4	46	23	25	35	16
VC710	5	56	34	27	39	20
VC711	6	68	46	28	48	24
VC712	8	90	68	30	53	29

INDUSTRIAL HEAVY-DUTY ALUMINUM 2-WAY PLATFORM STEPLADDERS (AMP1500 SERIES)

CSA Grade 1A, ANSI Type 1A, 300-lb. Load Rating

- Durable "C" channel side rails
- Large, safe and comfortable slip-resistant platform, 14 2/5" x 17 1/10"
- Top rail guard height is 21" above platform
- Wide 3" slip-resistant serrated aluminum steps for safe climbing
- Double-rivet step construction
- Heavy-duty slip-resistant safety shoes
- Rugged outside zinc-coated steel spreader arms



Louisville
LADDER

Model No.	Nominal Height'	Open Height"	Platform Height"	Base Width"	Base Depth"	Wt. lbs.
VD422	6	69 5/8	48	25 3/8	53 3/8	35
VD423	8	92 1/2	72	28 3/8	69 1/2	56
VD424	10	114 7/8	96	31 3/8	85	77
VD425	12	136 1/4	120	34 3/8	100 1/4	98

LADDERS & STANDS

HEAVY-DUTY WORKHORSES

- All-welded, ready to use
- Overbuilt to be the last sawhorse you'll ever need
- Capacity: 2000 lbs. each, evenly distributed
- Powder coated finish safety yellow



KLETON



VC158

Model No.	Height"	Width"	Depth"	Wt. lbs.
VC157	24	36	20	43
VC158	36	48	20	60

INDUSTRIAL EXTRA HEAVY-DUTY FIBREGLASS 2-WAY STEP STOOLS

CSA Grade 1AA, ANSI Type 1AA, 375-lb. Load Rating

- Height: 2'
- Wide 3" slip-resistant serrated aluminum steps for safe climbing
- Base width: 21"
- Base depth: 23"
- Slip-resistant feet
- Double-rivet step construction
- Weight: 11 lbs.

Model No. VD426



INDUSTRIAL HEAVY-DUTY FIBREGLASS WORKING PLATFORMS

CSA Grade 1A, ANSI Type 1A, 300-lb. Load Rating

- 12" wide slip-resistant standing platform
- Platform height: 21"
- Platform dimensions: 12" W x 37 1/4" D
- Base width: 16 1/4"
- Base depth: 46 7/8"
- Weight: 13 lbs.

Model No. VD404



ALUMINUM STEP STOOL/LADDERS (3400 SERIES)

CSA Grade 1A, ANSI Type 1A, 300-lb. Load Rating

- Super tough copolymer top for strength and durability
- Both front and rear legs are braced
- Solid aluminum rivets in front prevent steps from loosening
- Slip-resistant vinyl feet

FEATHERLITE
INDUSTRIAL LADDERS

Model No.	Height'	Base Width"	Spread"	Wt. lbs.
VC239	2	15 1/2	17 1/2	5
VC240	3	17	24	6

VC239



INDUSTRIAL-DUTY ALUMINUM SAWHORSES/STEPS

- Engineered to allow for convenient mixing of sizes in plank applications
- Durable extruded aluminum steps and side rails, serrated for strength and safety
- Trestle design allows safe access from either side
- J-shaped spreaders for easy set-up and storage
- Heavy-duty rubber safety shoes
- Capacity: 250 lbs.

FEATHERLITE
INDUSTRIAL LADDERS

Model No.	Height'	Open Height"	Base Width"	Base Depth"	Wt. lbs.
VC010	2	23	32	24 1/2	10
VC011	3	35	33	32	14
VC012	4	47 1/2	34 1/2	34 1/2	19



VC010

FIBREGLASS STEP STOOL/LADDERS (6400 SERIES)

CSA Grade 1A, ANSI Type 1A, 300-lb. Load Rating

- Super tough copolymer top for strength and durability
- Slip-resistant serrated aluminum steps
- Extra-large PVC rubber safety boots are heavy-duty and provide increased rail protection and slip-resistance

FEATHERLITE
INDUSTRIAL LADDERS

Model No.	Height'	Base Width"	Spread"	Approx Weight lbs.
VC211	2	17	17	8
MD487	3	19	23	12



VC211

LADDER CARTS

- Provides greater mobility, enhanced access, safe ladder handling, and minimal storage requirements
- Compact footprint increases maneuverability
- Safely carries a 6' ladder without hitting doorways, walls or elevators
- Tall profile improves access and offers a more comfortable work height
- Commercial-grade hybrid construction of powder-coated steel and structural foam
- Fully adaptable to work site requirements, with long-item storage, tool holders
- Perforated panels hold 1/4" and locking cabinets on model MI824
- Overall dimensions: 27" W x 31.5" D x 42" H
- Capacity: 500 lbs.



MI823



MI824

Model No. MI823

WITH LOCKABLE CABINET

Model No. MI824

ALUMINUM TELESCOPIC LADDERS

- Compact and easy to move, use and store
- Extends and locks in 12" increments
- Indicators let you know when the rungs are locked into place
- Anti-slip rungs
- Capacity: 250 lbs.
- CSA Grade 1

METALTECH

Model No.	Height'	Reach'	Closed Dimensions W" x D" x H"	Colour	Weight lbs.
VC441	12	16	19 x 4.5 x 32	Yellow	25
VC252	15	19	19.5 x 4.5 x 36	Blue	37

VC441



* Other sizes available

WORK PLATFORMS

HIGH WORK MAINTENANCE PLATFORMS

- Convert forklift truck into safe, efficient work platform
- Take care of overhead maintenance problems without setting up ladders or scaffolds
- Non-skid platform
- 72" safety mesh backscreen keeps operator and equipment away from lift mechanism
- Forks slip easily into pockets and are secured with safety chains
- Load capacity: 1000 lbs.
- No assembly required



MD444

MD948

KLETON

KLETON

Note:

Kleton maintenance platforms meet or exceed ASME B56.1 safety standard when a safety harness and lanyard are worn.

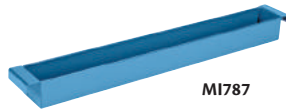

MI787

Model No.	Description	Wt. lbs.
MD444	High Work Platform - 36" x 36" platform	230
MH800	High Work Platform - 48" x 48" platform	300
MD338	Optional 6" caster kit	10
MD948*	Light Bulb Caddy 15" W x 15" D x 43" H	25
OPTIONAL TOOL TRAYS		
MI787	36" L x 4" W x 3" D, Fits on model MD444	-
MI788	48" L x 4" W x 3" D, Fits on model MH800	-

* Mounts on models MD444 and MH800.

MOBILE WORK SCAFFOLDING

Meets CSA & OSHA standards

MINI™ ALUMINUM SCAFFOLDING

- Multi-level working area
- Light aluminum frame
- Anti-slip 16-gauge steel platform adjust every 12", comes with 2 platforms
- Structure: Aluminum alloy 6061-T6 of 1.5"
- Dimensions: 3' 1/2" L x 1' 3/4" W x 4' 1/4" H
- Capacity: 600 lbs.
- Weight: 40 lbs.

Model No. VC031

Accessories:

- VC199 Anti-Slip Platform
- MB091 4" locking casters



VC031

DELTA™ HARNESSES

- Patented triangular No-Tangle™ design
- Repel™ webbing is water repellent
- Spring-loaded stand-up dorsal D-ring
- Impact indicators provide a visual alert that the harness has been involved in a fall
- Features tongue-buckle leg connections
- Universal size
- Certified to CSA standard Z259.10, Class A

Model No. SEB406 Mfg. No. 1102000C



3M

SALA

Fall Protection



EZ-STOP™ SHOCK ABSORBING LANYARDS

- Features the lightest, smallest, and strongest shock absorber in the world
- Thinnest-ever webbing using HI-10™ Vectran® energy management material, a multifilament high tenacity performance yarn spun from liquid crystal polymer that is five times stronger than steel
- Repel™ webbing repels water to reduce the attraction of mold and dirt
- High abrasion resistance
- Excellent chemical and cut resistance
- High impact resistance

Model No. SEJ420 Mfg. No. 1246011C



3M

SALA

Fall Protection



EMERGENCY STOP SWITCHES

- Safety kill switch for person on work platform
- Will cut power to forklift in case of an emergency
- Consists of control box for platform, plug-in box (to be installed on forklift), and wire that extends 6' to 20'
- Switch is easy to install
- Recommended for maintenance platform MD444 and MH800

Model No. MD328



MD328

MAXI SQUARE ALUMINUM SCAFFOLDING

- Lightness and sturdiness
- Can be used in stairways
- Anodized aluminum tube 1 1/2" sq. frame
- Anti-slip anodized aluminum platform adjusts every 2", comes with one platform
- Dimensions: 6' 2" L x 2' 5" W x 6' 3" H
- Capacity: 700 lbs.
- Weight: 90 lbs.

Model No. VC032



VC032

ACCESSORIES



Model No.	Description
VC203	Set of Four Outriggers w/Casters
VC202	5" Swivel Caster with Locking System
VC204	Guardrail System

STEEL SCAFFOLDING

- Multi-level working area
- 1" O.D. 16-gauge steel frame
- Two anti-slip 14-gauge steel platforms
- Height: 4'
- Reach: 9'
- 4" heavy-duty double locking casters
- Units fold/collapse for easy storage
- Capacity: 500 lbs.
- Yellow powder coat finish
- Meets and exceeds CSA, OSHA & ANSI standards



VC781



VC782

Model No.	Overall Dimensions L" x W" x H"	Weight lbs.
VC782	41 x 22 1/2 x 45 3/4	50
VC781	49 1/2 x 22 1/2 x 57 3/4	59

Note: More sizes & options available upon request

STEP STOOLS, STANDS & LADDERS

STEP STOOLS

HEAVY-DUTY STEP STOOLS

- Comes with a double platform with non-slip rubber tread
- Spring-loaded casters retract under slight pressure, forcing base to the floor
- 11" diameter upper platform and 13 1/2" diameter lower platform
- 17 1/4" diameter base has an all-around protective bumper
- 16 1/2" overall height
- Capacity: 500 lbs.
- Wt.: 10 lbs.



Model No. ON528



STEP STOOLS

- Tough 1-piece poly construction with anti-skid bottom
- Threaded top and expanded step
- 16" diameter base provides added stability
- Glides easily on retractable rubber casters
- 13" overall height
- Capacity: 350 lbs.
- Wt.: 7 lbs.



OA300



Model No.	Mfg. No.	Colour
OA299	2523BL	Black
OA300	2523BE	Beige

INDUSTRIAL STEP STOOLS

- Durable, nestable, corrosion-proof
- Moulded-in handles make them easy to carry
- Includes rubber feet and a non skid tape surface
- Capacity: 500 lbs.
- Colour: Safety Yellow

MN532



Model No.	Description	Overall Dimensions L" x W" x H"	Wt. lbs.
MN531	Single Step	28 x 20 x 13	10
MN532	Double Step	36 x 28 x 20	20

INDUSTRIAL STEP STOOLS

- Durable, corrosion-proof, 500-lb. capacity polyethylene construction
- Two, three and four step stools have rear opening to access storage compartments
- Four-step stool comes standard with handrails and casters
- Hand holes and light weight combine for easy manoeuvrability
- All stools include rubber feet and non skid tape surface
- Safety yellow for visibility
- Also available in other colours



MN601

NESTABLE INDUSTRIAL STEP STOOLS

- Durable, nestable, corrosion-proof
- Hand holes and light weight combine for easy manoeuvrability
- Includes rubber feet and a non skid tape surface
- Pronounced ribbing provides additional structural support
- Capacity: 500 lbs.
- Colour: Safety Yellow



MN658

Model No.	Description	Overall Dimensions L" x W" x H"	Wt. lbs.
MN599	Single Step	18 x 12 x 12	7.5
MN600	Double Step	22 x 21 x 20	16.2
MN601	Triple Step	32 x 22 x 30	33
MN644	Quad Step w/Casters	43 x 22 1/2 x 66	53

Model No.	Description	Overall Dimensions L" x W" x H"	Wt. lbs.
MN656	Single Step	25 x 25 x 10 1/2	8.5
MN657	Single Step	25 x 25 x 14 3/4	11
MN658	Double Step	32 3/4 x 25 3/4 x 20	18.5
MN659	Double Step	33 x 25 3/4 x 24	19

STEP STANDS

- Rugged all-welded construction
- Rolling stands come with spring-loaded casters
- Dimensions: 16" D x 12" H • Capacity: 300 lbs.
- Durable Kleton blue enamel finish
- Meets ANSI standard A14.7



MH225

STEP STANDS

Model No.	Base Width"	Platform Dimensions W" x D"	Wt. lbs.
MH228	20	18 x 16	11
MH229	24	22 x 16	13
MH230	32	30 x 16	16

ROLLING STANDS

Model No.	Base Width"	Platform Dimensions W" x D"	Wt. lbs.
MH225	20	18 x 16	17
MH226	24	22 x 16	19
MH227	32	30 x 16	22

4' ALUMINUM LIGHT-DUTY PLATFORM STANDS (1300 SERIES)

CSA Grade 3, ANSI Type 3, 200-lb. Load Rating

- 1" tubular construction makes this ladder lightweight and compact for storage
- Handrail with comfort foam grip
- Fold-down utility tray for paint, tools, etc.
- Non-marring, slip-resistant feet
- Overall height: closed: 55"; open: 51"
- Overall platform height: 22 1/2"
- Approximate weight: 8 lbs.

Model No. TJZ869



WORK STEP STANDS

- Solid all-welded construction
- Elevate workers to comfortable working heights
- Provides solid footing around machinery and other work areas
- Capacity: 800 lbs.
- Durable Kleton blue enamel finish

Model No.	Platform Dimensions W" x D"	Top Step Height"	Wt. lbs.
VC127	24 x 32	6	28
VC128	32 x 32	6	34
VC129	24 x 32	12	32
VC130	32 x 32	12	38



VC127



REPLACEMENT PARTS

Model No.	Description
VC055	Rubber Foot Tip



TILT-N-ROLL STEP STANDS

- Frame is welded 1" round steel tubing
- Non-clogging slip-resistant steel steps
- Handle allows step stand to move easily on two 4" casters
- Capacity: 300 lbs.
- Durable Kleton blue enamel finish
- Meets ANSI standard A14.7

VC336



Model No.	No. of Steps	Step Dimension W" x D"	Top Step W" x D"	Top Step Height"	Base Dim. W" x D"	Wt. lbs.
VC335	1	22 x 8	22 x 16	12	29 x 16	24
VC336	2	22 x 8	22 x 16	19	29 x 24	33

ROLLING LADDERS

ROLLING LADDER STANDS

- Ideal wherever there is a need to reach bulky materials
- Roll easily into position and lock firmly to the floor for maximum safety
- 2 to 6-step ladders operate on spring-loaded casters
- Casters retract under operator's weight, rubber feet drop down
- First step on all 8 to 16-step ladders activates the floor locking mechanism (step off and kick release to make the ladder mobile)
- Non-clogging slip-resistant steel steps
- Frame is rugged welded 1" round steel tubing
- 8 to 16-step ladders shipped knocked down, easily assembled
- Capacity: 300 lbs.
- Durable Kleton blue enamel finish
- **CSA certified to the ANSI A14.7 standard**

Note:
Ladders are not to be used as work platforms.



Model No.	No. of Steps	Top Step Height"	Overall Height"	Top Step W" x D"	Base W" x D"	Wt. lbs.
WITHOUT HANDRAILS						
MA612	2	19	19	22 x 16	24 x 26	32
MA613	3	28	28	22 x 16	24 x 30	42
MH279	4	37	37	22 x 16	24 x 37	52
MA615	5	46	46	22 x 16	24 x 41	61
WITH HANDRAILS						
MA614*	4	37	78	22 x 16	30 x 36	78
MA616*	5	46	87	22 x 16	30 x 46	89
MA617*	6	55	95	22 x 16	30 x 51	100
MA622**	8	72	113	30 x 16	38 x 60	180
MA623**	10	89	130	30 x 16	38 x 72	230
MA624**	12	109	149	30 x 16	38 x 80	250
MA625**	14	128	167	30 x 16	38 x 93	275
MA626**	16	144	185	30 x 16	38 x 104	305

* Only front casters are spring loaded. ** Locking step.

MECHANICS/MAINTENANCE ROLLING LADDER STANDS

- Double-straddle base puts worker in close proximity for hard-to-reach jobs
- Tilt and roll wheelbarrow mobility allows easy movement over rough surfaces
- Oversize 22" W x 24" D top step for easier worker movement
- Removable 24" W x 10" D tool tray fits on front or side railing (included)
- Capacity: 300 lbs.
- Durable Kleton blue enamel finish



Tool Tray Included
MH242



Model No.	No. of Steps	Top Step Height"	Overall Height"	Base W" x D"	Wt. lbs.
MH212	3	28	58	24 x 44	85
MH213	4	38	68	24 x 50	98
MH214	5	47	77	24 x 56	112
MH215	6	57	87	24 x 68	125

TILT-N-ROLL LADDER STANDS

- Balanced design allows ladder to tilt into the rolling position
- Ladder moves easily two 4" casters
- 1-piece all-welded steel construction
- Legs have reinforced rubber tips that hold ladder secure during use
- Oversize 22" W x 24" D top step allows worker more freedom/movement and comfort
- 30" high rails with 24" wide expanded metal steps
- Capacity: 300 lbs.
- Durable Kleton blue enamel finish



Optional Tool Tray MH242



Model No.	No. of Steps	Top Step Height"	Overall Height"	Base W" x D"	Wt. lbs.
MD603	3	27	57	25 x 44	70
MD604	4	38	68	25 x 50	81
MD605	5	47	77	25 x 56	93
MD606	6	56	86	25 x 62	105
MH242	Optional tool tray				9

ROLLING STEP STANDS

- Ideal wherever there is a need to reach materials
- Rolls easily into position and locks firmly to the floor for maximum safety
- All the ladders operate on spring-loaded casters
- Casters retract under operator's weight and rubber feet drop down
- Non-clogging slip-resistant steel steps
- Frame is welded 1" round steel tubing
- Capacity: 300 lbs.
- Durable Kleton blue enamel finish

Model No.	No. of Steps	Step W" x D"	Top Step W" x D" x H"	Base W" x D"	Wt. lbs.
VC131	2	18 x 8	18 x 16 x 19	20 x 26	28
VC132	3	18 x 8	18 x 16 x 28	20 x 30	38
VC133	4	18 x 8	18 x 16 x 37	20 x 37	48
VC134	5	18 x 8	18 x 16 x 46	20 x 41	57



ROLLING LADDERS

PORTABLE FOLDING LADDERS

- Foldable locking design saves onstorage space when not in use
- Welded construction
- 58° slope, 7" deep steps for easy climbing
- Perforated step
- Locks in the folded or climbing positions
- Approximately 10" deep when folded for easy storage
- Maximum capacity: 350 lbs.



KLETON

Model No.	No. of Steps	Top Step Height"	Open W" x L"	Folded Dimensions W" x D" x H"	Wt. lbs.
VC436	2	20	24 x 17	24 x 10 x 41	30
VC437	3	30	24 x 23	24 x 10 x 52	35
VC438	4	40	24 x 30	24 x 10 x 65	42

ALUMINUM ROLLING LADDERS

- Widely used in hospitals, banks, offices, pharmaceutical and food processing applications
- Corrosion resistant, easy to clean and non-magnetic
- 3/4" schedule 40, 1-1/16" O.D. pipe
- 7" deep steps
- 14" deep top step
- Slip-resistant ribbed tread style steps, a more aggressive serrated is available upon request for all sizes
- Spring-loaded casters included on 2-7 step models only
- Step lock included on 8-12 step models only
- Capacity: 350 lbs.
- All-welded with unpainted aluminum mill finish
- Complies with OSHA and ANSI standards



TRIARC

Number of Steps	Top Step Height"	Overall Height"	16" W Step Model No.	Base W" x D"	24" W Step Model No.	Base W" x D"
WITHOUT HANDRAILS						
1	10	10	VC470	16 x 14	VC471	24 x 14
2	20	20	VC472	19 x 24	VC473	28 x 24
3	30	30	VC474	21 x 30	VC475	28 x 30
4	40	40	VC476	21 x 36	VC477	29 x 36
WITH HANDRAILS						
2	20	52	VC478	19 x 24	VC479	28 x 24
3	30	62	VC480	21 x 31	VC481	29 x 31
4	40	72	VC482	21 x 37	VC483	30 x 37
5	50	82	VC484	21 x 44	VC485	30 x 44
6	60	92	VC486	26 x 51	VC487	32 x 51
7	70	102	VC488	26 x 57	VC489	32 x 57

Also available in other sizes and tread styles

ROLL & FOLD STEEL ROLLING LADDERS

- Mobile ladder can be folded for space-saving storage or transporting
- Ideal for use on asphalt or similar rough surfaces
- 1-1/16" tubular steel construction
- 16" W x 10" D top step with 16" W x 7" D intermediate steps
- Two 10" diameter semi-pneumatic wheels on rear of ladder, reinforced rubber tips on front legs to secure ladder during use
- Capacity: 450 lbs.
- Grey powder coat finish
- Complies with OSHA and ANSI standards
- Shipped knocked down



TRIARC

Number of Steps	Top Step Height"	Base W" x D"	Overall Height"	Perforated Step Tread Model No.	Grip Strut Step Tread Model No.
6	66	27 x 50	90	VC523	VC533
7	76	27 x 57	100	VC524	VC534
8	86	36 x 63	112	VC525	VC535
9	96	36 x 70	122	VC526	VC536
10	106	36 x 77	132	VC527	VC537
11	116	36 x 83	142	VC528	VC538
12	126	36 x 90	152	VC529	VC539

Also available in other sizes

ALUMINUM STOP-STEP LADDERS

- Stops still when you step on it
- Gives 18" to 54" of firm footing
- 1" square high tensile aluminum struts, frames and braces
- Heavy gauge extruded aluminum 16" x 8" cross steps with 9" raise
- Long lasting 1 5/8" retractable casters allow rubber base cups to grip floor
- Download rating: 300 lbs.
- Colour: Beige
- OSHA compliant
- 10 year limited warranty
- Shipped knocked down



cramer

Model No.	No. of Steps	Top Step Height"	Overall Dimensions W" x D" x H"	Wt. lbs.
STOP-STEP				
MD623	2	18	21 x 19 3/4 x 22 3/4	16
MD624	3	27	21 x 26 3/4 x 31 3/4	22
MD625	4	36	22 3/4 x 33 1/2 x 40 3/4	34
STOP-STEP W/DOUBLE HANDRAIL				
MD626	3	27	21 x 26 3/4 x 56 1/2	32
MD627	4	36	23 3/4 x 33 1/2 x 65 1/2	39

ALL DIRECTIONAL STEEL ROLLING LADDERS

- Ladder turns within its own radius; rolls in all directions
- 1 1/16" tubular steel construction
- 24" W x 10" D top step with 24" W x 7" D intermediate steps
- Step lock standard on all models
- Capacity: 450 lbs.
- Grey powder coat finish
- Complies with OSHA and ANSI standards
- Shipped knocked down



TRIARC

Number of Steps	Top Step Height"	Base W" x D"	Overall Height"	Perforated Step Tread Model No.	Grip Strut Step Tread Model No.
7	70	35 x 56	106	VC540	VC550
8	80	35 x 63	116	VC541	VC551
9	90	35 x 68	126	VC542	VC552
10	100	35 x 75	136	VC543	VC553
11	110	35 x 82	146	VC544	VC554
12	120	35 x 89	156	VC545	VC555

Also available with a 50° forward descent safety angle

50° SAFETY SLOPE STEEL ROLLING LADDERS

- 1 1/16" tubular steel construction
- 24" W x 17" D top step with 24" W x 8 1/2" D intermediate steps
- Step lock included on all models
- Capacity: 450 lbs.
- Grey powder coat finish
- Complies with OSHA and ANSI standards
- Shipped knocked down



TRIARC

Number of Steps	Top Step Height"	Base W" x D"	Overall Height"	Perforated Step Tread Model No.	Grip Strut Step Tread Model No.
6	60	35 x 66	96	VC607	VC621
7	70	35 x 74	106	VC608	VC622
8	80	35 x 82	116	VC609	VC623
9	90	35 x 91	126	VC610	VC624
10	100	35 x 99	136	VC611	VC625
11	110	35 x 107	146	VC612	VC626
12	120	35 x 116	156	VC613	VC627

Also available in other sizes

TOOL STORAGE

EZ-LOADER® SKID BOLSTERS

- Fork lift from any side
- Easily load or unload heavy, fully loaded boxes from any sides
- One piece 7-gauge steel skid bolster reinforces the bottom of the box
- With holes for optional casters

TEXTURED POWDER PAINT FINISH

- Improved durability over liquid paint
- 10 times more corrosion resistance
- 5 times more abrasion resistance
- 2 times more chip resistance
- 2 times more scratch resistance

SITE-VAULT™ SECURITY SYSTEM

- 3-locking point system
- Cover plates protect the 3-lock hooks from being bent, broken, cut or pulled out
- Full length, high strength 12-gauge lock console protects the system and reinforces the front of the lid or door
- Exclusive: fluorescent reflective orange tape indicates when the JOBOX is unlocked

JOBBOX CHESTS

- Site-Vault™ security system
- Ez-Loader® skid bolsters
- Grip-Rite™ recessed lifting channel
- Staked and welded hinge: 14-gauge steel, 3/8 continuous hinges with 1/4" steel pin and extra-large 1" knuckles
- Heavily reinforced lid and body



JOBBOX

Model No.	Dimensions				Usable Cu. Ft.	Wt. lbs.
	W"	x	D"	x H"		
TEP092	36	x	20	x 23 3/4	8.3	98
TEP136	42	x	20	x 23 3/4	9.3	118
TEP137	48	x	24	x 27 3/4	15.4	148
TEP156	60	x	24	x 27 3/4	19.3	182
TEP157	48	x	30	x 33 3/8	24.3	190
TEP158	72	x	24	x 27 3/4	23.2	220

SMALL CHESTS & WELDER'S BOXES

- Compact and portable for flexible, secure storage
- A heavily-reinforced 16-gauge steel construction
- **TEP175** offers a heavily-reinforced lid able to resist pry bar entry, a recessed grip channel for opening lid, a bolt cutter proof locking system with a padlock (not included, **SR890**) protecting the lock from bolt cutters and pry bars and tall, strong bottom bolsters
- Staked and welded steel hinges
- **TEP348** is a welder's box that offers a notched upper side for storing tools connected to supply hoses

JOBBOX



TEP175



TEP348

Model No.	Description	Dimensions				Usable Cu. Ft.	Wt. lbs.
		W"	x	D"	x H"		
TEP175	Small Chest w/Embedded Lock	31	x	18	x 15 1/2	4	5.7
TEP349	Small Chest w/Hasp Lock	30	x	16	x 12	3.3	4.6
TEP348	Welder's Box	30	x	16	x 12	3.3	4.6

FIELD OFFICE

- Site-Vault™ security system
- Ez-Loader® skid bolsters
- One handle lock operation
- 30 cu. ft. storage locker
- Full length heavy-duty stainless steel hinges
- Built-in bottom door storage shelves
- Features overhead tube storage, steel pegboard, storage area for plans and binders, lockable large desktop area and door safety pin latch



Model No.	Dimensions				Usable Cu. Ft.	Wt. lbs.
	W"	x	D"	x H"		
TEP167	63	x	42	x 80	100	660

JOBBOX

SLOPE LID CHESTS

- All the characteristics of a regular Jobsite Chest plus:
 - Propped lid allows for a flat working surface
 - Full length reinforced channel
 - Lift-N-Stow hinged shelf to store bulky items in the bottom
- 60" W x 30" D x 39 1/2" H
- Usable cu. ft.: 32.7
- Weight: 243 lbs.

Model No. TEP159

JOBBOX



CASTERS

- Heavy-duty casters for added mobility
- **Set includes:** Two fixed and two swivels
- Hardware included

4"

Model No. TEP230

6"

Model No. TEP231



PIANO BOXES

- Site-Vault™ security system
- Ez-Loader® skid bolsters
- Grip-Rite™ recessed lifting channel
- Lift-N-Stow bottom shelf
- 3/8 continuous hinges with 1/4" steel pin and extra-large 1" knuckles
- Gas spring door lifts with quick release mount
- Recessed handles, door opens full 90°
- Two storage bins on both sides of walls
- Formed lid sides welded to lid bolsters resists pry bar entry
- **TEP164:** Punch holes for hanging safety harnesses, three shelves with 500-lb. capacity and three storage bins
- **TEP165** and **TEP166:** Tapered drop down ramp that closes with a padlock (not included)



JOBBOX

Model No.	Dimensions				Usable Cu. Ft.	Wt. lbs.
	W"	x	D"	x H"		
TEP161	48	x	31	x 50	38	286
TEP162	60	x	31	x 50	47.5	326
TEP163	74	x	31	x 50	56.5	423

HIGH CAPACITY MODEL

TEP164	74	x	34 5/8	x	63	85.7	500
--------	----	---	--------	---	----	------	-----

DROP-FRONT MODELS

TEP165	60	x	30	x	50	47.5	405
TEP166	74	x	30	x	50	56.5	468

DRAWER CABINETS

- Site-Vault™ security system
- Ez-Loader® anti-tip skid bolsters
- Hand or foot operated latch released system
- 4 1/2" deep top shelf and 3" x 3" deep shelves on each door
- 3/8 continuous hinges with hardened 1/4" steel pin and extra-large 1" knuckles
- Three 5/8" steel locking pins per door
- High load capacity drawer: Three 2 1/2" deep drawers have 75-lb. capacity, five 5 1/2" deep drawers have 125-lb. load rating
- 60 1/8" W x 30 1/4" D x 53 1/4" H
- Usable cu. ft.: 58.7
- Weight: 610 lbs.

Model No. TEP173

JOBBOX



CABINETS

- Site-Vault™ security system
- Heavy-duty doors with Grip-Rite™ channel
- Hand or foot operated latch released system
- 3/8 continuous hinges with hardened 1/4" steel pin and extra-large 1" knuckles
- Heavy-duty high strength shelves
- Three 5/8" steel locking pins per door
- Five models to choose from:

TEP168: Two doors, 24" deep
TEP169: Four doors, features front and back access
TEP170: Two doors, tall closed on right side
TEP171: Two doors, 30" deep
TEP172: Two doors, bin and clam shell, has heavy-duty galvanised movable dividers



Model No.	Dimensions			Usable Cu. Ft.	Wt. lbs.
	W"	D"	H"		
TEP168	60 1/8	x 24 1/4	x 60 3/4	47.5	379
TEP169	60 1/8	x 32 1/4	x 60 3/4	63.7	523
TEP170	60 1/8	x 24 1/4	x 60 3/4	47.5	366
TEP171	60 1/8	x 30 1/4	x 60 3/4	58.7	436
TEP172	72	x 24	x 60 5/8	49	522

HEAVY-DUTY EQUIPMENT BOX

- Designed for extreme applications on any job site
- Innovative design combines Jobox toughness with total access by adding an industry leading drop down ramp
- Site-Vault™ security system provides complete security for your tools
- Reinforced ramp locks with two internal sliding gate bolts and padlock
- Tapered drop-down ramp facilitates rolling larger, heavier tools and equipment in and out safely
- Additional storage bins on back wall for small tools & parts
- Ability to install optional casters
- Overall Depth: 70"
- Overall Height: 38"
- Overall Width: 31"
- Colour: Red
- Material: Steel
- Capacity: 50.5 Cubic Feet

Model No. TEQ699
 Mfg No. 1-687990

JOBBOX



ROLLING WORK BENCHES

- High capacity, fully adjustable interior; drawers and shelves are easy to move to match your requirements, additional drawers and shelves can be added in
- 18-gauge steel drawers with heavy-duty ball bearing glides
- **Includes:** Two fixed and two lockable swivelling casters



Model No.	Description	Dimensions				Usable Cu. Ft.	Wt. lbs.
		W"	D"	x H"	x H"		
TEP180	Basic Unit with 6" Casters	49 7/8	x 26 7/8	x 40 5/8	24.6	264	
TEP176	2 Drawers, 2 Shelves, 4" Casters	43 7/8	x 26 7/8	x 38 1/2	21.7	266.5	
TEP177	2 Drawers, 2 Shelves, 6" Casters	43 7/8	x 26 7/8	x 40 1/2	21.7	279.5	
TEP178	4 Drawers, 1 Shelf, 4" Casters	43 7/8	x 26 7/8	x 38 1/2	21.7	294	
TEP179	4 Drawers, 1 Shelf, 6" Casters	43 7/8	x 26 7/8	x 40 1/2	21.7	307	
TEP181	6 Drawers, 1 Shelf, 6" Casters	49 7/8	x 26 7/8	x 40 5/8	24.6	342	

Additional drawers and shelves available upon request

ROLLING CLAM SHELL CABINET

- Weight: 472 lbs.
- Rugged 16-gauge steel construction;
- Colour: Red
- Overall Width: 62-1/2"
- Overall Depth: 30"
- Overall Height: 63-1/2"
- Material: Steel
- Capacity: 72 Cubic Feet

Model No. TEP174
 Mfg No. 692990



JOBBOX

JOBSITE CHESTS

- Steel body and lid provide superior security for tools and equipment
- Bolt cutter proof locking system protects padlock inside 12-gauge steel housing
- Heavy-duty hinge is staked and welded to prevent the pin from being driven out to break in
- Lifting handles are protected inside tall, deep recessed to prevent pinched knuckles and damage
- Heavy-duty locking arm secures the lid in the open position
- Tall bottom bolsters for easily moving a loaded chest with a forklift
- 1-year limited warranty

JOBBOX

Model No.	Dimensions			Usable Cu. Ft.	Wt. lbs.
	W"	D"	H"		
TEP226	36	x 19 1/2	x 22	6.8	85
TEP227	42	x 20	x 23 1/2	9.3	101
TEP211	48	x 24	x 27 1/2	15.4	133
TEP212	60	x 24	x 27 1/2	19.2	155



TOOL STORAGE

DEFENDER SERIES™ FULL-SIZE TRUCK STANDARD SADDLE

- Delivers heavy duty security with two hook loop strikers and dual stage rotary latches
- Professional durability with four piece welded construction
- Weather resistance from full weather seal with D shaped ribbed weather stripping
- Tamper resistant push button locks - drill resistant through key hole
- Heavy duty pry resistance with C channel reinforced welded lid construction and reinforced front body panel
- Dual gas strut supported lid with protective sleeves
- Black boxes are black powder coated inside and out for maximum protection against oxidation
- Fits full size pick-up trucks
- Seven year warranty
- Overall Width: 71-1/4"
- Overall Depth: 19-1/2"
- Overall Height: 17-3/4"
- Material: Aluminum

BLACK

Model No TEQ670
Mfg. No. 300401-53-01



weather guard

SILVER

Model No TEQ671
Mfg. No. 300401-9-01

DEFENDER SERIES™ UNIVERSAL TRUCK CHEST

- Tamper resistant push button locks - drill resistant through key hole
- Heavy duty pry resistance with C channel reinforced welded lid construction and reinforced front body panel
- Dual gas strut supported lid with protective sleeves
- One touch push button locks pop open the box easily even when your hands are full
- Fits compact and full size pick-up trucks
- Black boxes are black powder coated inside and out for maximum protection against oxidation
- Seven year warranty
- Overall Width: 50-3/4"
- Overall Depth: 18-3/4"
- Overall Height: 19-1/4"
- Material: Aluminum

BLACK

Model No TEQ678
Mfg. No. 300401-53-01

SILVER

Model No TEQ679
Mfg. No. 300401-9-01



weather guard

DEFENDER SERIES™ STANDARD LO-SIDE TRUCK BOX

- Delivers heavy duty security with a dual stage rotary latch and a reinforced hook loop striker
- Professional durability with four piece welded construction
- Weather resistance from full weather seal with D shaped ribbed weather stripping
- Tamper resistant push button locks - drill resistant through key hole
- Heavy duty pry resistance with C channel reinforced welded lid construction and reinforced front body panel
- Dual gas strut supported lid with protective sleeves
- Fits full size pick-up trucks
- Black boxes are black powder coated inside and out for maximum protection against oxidation
- Seven year warranty
- Overall Width: 58-3/4"
- Overall Depth: 15-3/4"
- Overall Height: 13-1/4"
- Material: Aluminum

BLACK

Model No TEQ680
Mfg. No. 300300-53-01

SILVER

Model No TEQ681
Mfg. No. 300300-9-01



weather guard

DEFENDER SERIES™ FULL-SIZE TRUCK STANDARD CROSS

- Delivers heavy duty security with a hook loop striker and dual stage rotary latch on each lid
- Professional durability with four piece welded construction
- Weather resistance from full weather seal with D shaped ribbed weather stripping
- Tamper resistant push button locks - drill resistant through key hole
- Heavy duty pry resistance with C channel reinforced welded lid construction and reinforced front body panel
- Dual protected gas strut supported lids for accessibility from both sides of the truck
- Black boxes are black powder coated inside and out for maximum protection against oxidation
- Fits full size pick-up trucks
- Seven year warranty
- Overall Width: 71-1/2"
- Overall Depth: 19-1/2"
- Overall Height: 17-3/4"
- Material: Aluminum

BLACK

Model No TEQ672
Mfg. No. 300207-53-01

SILVER

Model No TEQ673
Mfg. No. 300207-9-01



weather guard

REDARMOUR™ FULL-SIZE TRUCK SADDLE BOX

- Delivers reliable security with two hook loop strikers and rotary latches
- Standard durability with four-piece welded aluminum construction
- Weather resistance from full weather seal with bulb weather stripping
- Push button locks - provide easy access
- Pry resistance with C-channel reinforced welded lid construction
- Dual gas strut supported lid with protective sleeves
- Fits full size pick-up trucks
- Two year warranty
- Colour: Silver
- Overall Width: 71"
- Overall Depth: 19-1/2"
- Overall Height: 17-1/4"
- Material: Aluminum

Model No TEQ682

Mfg. No. 300300-53-01



weather guard

DEFENDER SERIES™ HI-SIDE TRUCK BOX

- Delivers heavy duty security with a C channel reinforced welded door
- Professional durability with welded aluminum construction
- Weather resistance from full weather seal with D shaped ribbed weather stripping
- Tamper resistant push button locks - drill resistant through key hole
- Heavy duty pry resistance with C channel reinforced welded door
- Door is supported with durable steel cables
- Carabineer clips make it easier to lower the door
- Heavy duty powder coated 1/4" thick steel support legs
- Black boxes are black powder coated inside and out for maximum protection against oxidation
- Seven year warranty
- Overall Width: 60"
- Overall Depth: 13-1/4"
- Overall Height: 16"
- Material: Aluminum

TEQ677

TEQ674



weather guard

Model No.	Mfg No.	Overall Dimensions					Colour
		W"	x	D"	x	H"	
TEQ674	300302-53-01	60	x	13-1/4	x	16	Black
TEQ675	300302-9-01	60	x	13-1/4	x	16	Silver
TEQ676	300303-53-01	90	x	13-1/4	x	16	Black
TEQ677	300303-9-01	90	x	13-1/4	x	16	Silver

MULTI-PURPOSE TOOL HOLDERS

- Four pockets made of ballistic nylon
- Versatile 3-way attachment for pants, web suspenders, work aprons, etc.
- Securely holds small tools or accessories like pliers, mini flashlights, screwdrivers, etc.
- Dimensions: 5 1/4" L x 8 1/2" H

Model No. W1957



SNIPS, PENS & TAPE HOLDER

- Made of polyester fabric
- Designed for utility and "lock-back"-style knives, pliers or snips
- Sleeves for pens, markers, carpenter's pencils, with integral measuring tape clip
- Material: Polyester
- Colour: Black
- No. of Pockets: 1
- Style: Knife Holder

Model No. TEP509



48-POCKET BUCKET BUDDY

- 14 double row pockets inside and 34 triple row pockets outside organize a wide range of tools and accessories
- Security pocket with hook and loop closure
- Drill pocket with hook and loop handle strap
- Designed to fit most 3 1/2 - 5 gallon buckets
- Measuring tape strap and key clip included

Model No. VQ267



TAPE HOLDERS

- Made of top grain leather
- Designed to fit up to 30" tapes
- All rivet construction
- Dimensions: 6 3/4" L x 4 1/2" H

Model No. TBN166

Model No. TN238 - Black



11-POCKET PROFESSIONAL ELECTRICIAN'S POUCHES

- Double layer of rugged, lightweight nylon
- Two large main pockets, three smaller pockets
- Six large screwdriver holders, electrical tape chain and tool snap
- Metal clip holds all measuring tape sizes
- Dimensions: 8 1/2" L x 14 1/2" H

Model No. W1969



TECHGEAR™ 53-POCKET TOOL BACKPACK

- Length: 16"
- Width: 13-1/4"
- Material: Polyester
- Handy, integrated 3-level LED light system
- LED light handle can be easily directed at work area or into tool carrier
- Reinforced carrying handles and adjustable shoulder straps
- Powered by two AAA batteries, included

Model No. TEQ489



CORDLESS DRILL HOLSTERS

- Made of polyester fabric
- Holds most brands of T-handle drills
- Multiple outer pockets and sleeves for complete bit organization
- Elastic sleeve to hold drill bits, sockets, etc.
- Safety strap with quick-release buckle
- Hook and loop backing to keep strap back when not in use
- Holster is angled for better balance
- Fits belts to 2 3/4" wide

Model No. TEP222



UTILITY KNIFE, PEN/PENCIL HOLDERS

- Made of full grain leather
- Designed to fit pen/pencil and utility knife
- Comes with quick release snap belt loop
- Dimensions: 7 3/4" L x 2 3/4" H

Model No. TBN197



CONTRACTOR WORK BELT W/SUSPENSION RIG

- 29-pockets for organizing tools
- 1680D nylon construction
- Riveted seams
- All metal hardware
- Integrated carry handles
- Puncture resistant pocket
- Padded work belt fits 30 in. to 53 in. waists
- Smart phone pocket

Model No. TEQ663



IMPACT DRIVER HOLSTERS

- Made of polyester fabric
- Designed for smaller 10.8 V - 18 V cordless impact drivers
- Adjustable strap and quick-release buckle holds driver securely in place
- Elastic sleeve to hold drill bits, sockets, etc.
- Hook and loop backing to keep strap back when not in use
- Holster is angled for better balance
- Fits belts to 2 3/4" wide

Model No. TEP221



TOOL POUCHES

- Made of full grain leather
- Designed to fit assorted utility items: pens, markers, tape, utility knife, etc.
- 2" wide belt slots
- Rivet reinforced
- Dimensions: 3 3/4" L x 11" H

Model No. TSW497



16-POCKET CARPENTER'S TOOL BELT COMBO

- Fits waist sizes 29" - 46"
- 9 main pockets with 7 smaller pockets and sleeves for nails, parts, tools, nail sets, pencils, and more
- 3" padded, air-mesh fabric belt helps reduce heat and moisture accumulation
- Material: Polyester

Model No. TEQ604



TOOL STORAGE

17" ROLLING TOOL BAG

- Large, sturdy telescoping handle
- Heavy-duty treaded wheels for easy bag movement over rough terrain
- Large interior that holds most large power tools and accessories
- 6 Multi-use pockets inside and 11 outside to help organize a wide variety of hand tools
- Colour: Black & Yellow
- Material: Polyester
- No. of Pockets: 17

Model No. TEQ596 - w/LED

- LED Light Feature: Not Included

Model No. TEQ595 - w/o LED



16" TRADESMAN CLOSED TOP TOOL BAG

- Open design easy access tool carrier has 33 tool pockets and sleeves
- Includes a zippered main compartment, padded handles, and abrasion resistant rubber feet
- Material: Polyester

Model No. TEQ590



24" PROFESSIONAL CONTRACTORS GEAR BAG

- Features an open design for easy access to the tool carrier and has a large interior compartment
- Includes 4 individual parts pockets and one zippered pocket, and 4 exterior pockets/2 flap-covered
- Material: Polyester
- No. of Pockets: 11

Model No. TEQ589



TOUGHSYSTEM®

- Durable structural foam box walls give robust structure to the stand alone units
- Integrated water seal in every unit for protection of contents and long life for your equipment

TYP053



TYP055



TYP054



TYP056



TYP052



TYP051



TYP058



Model No.	Description	Overall Depth"	Overall Height"	Overall Width"
TYP053	DS150 Small Case	21-11/16	6-5/16	13-5/16
TYP055	DS300 Large Case	21-13/16	12-11/16	13-11/16
TYP054	DS400 XL Case	21-11/16	16-3/32	14-13/32
TYP056	DS250 Drawer Unit	21-29/32	12-11/16	13-19/32
TYP052	Tote	21-29/32	10-29/32	12-13/32
TYP051	Organizer	21-19/32	4-1/2	13-13/16
TYP058	DS Carrier	-	-	-

TSTAK®

- The TSTAK® system is a flexible platform that allows for many different combinations based on the user's needs



TYP042



TYP044



TYP045



TYP047



TYP048



TYP046



TYP043



TYP050



Model No.	Description	Overall Depth"	Overall Height"	Overall Width"
TYP042	Tool Box with Single Deep Drawer	16-11/16	6-7/8	2-1/4
TYP044	Tool Box with Double Shallow Drawers	17-5/16	6-29/32	6-5/16
TYP045	Organizer with Clear Lid	17-5/16	5-19/32	13
TYP047	Tool Box with Flat Top	17-5/16	13	6-1/2
TYP046	Deep Box	17-5/16	13	11-29/32
TYP048	Tool Box with Long Handle	17-5/16	13	6-5/16
TYP043	Tool Cart	-	-	-
TYP050	Trolley	-	-	-

PLASTIC TOOL BOXES

- ABS plastic latches
- Heavy-duty polypropylene fabrication
- Removable inner trays
- Deep storage compartments
- Padlock eye for safe storage

aurora tools®

Model No.	Dimensions			Features
	W"	x D"	x H"	
TLV082	15	x 7	x 5 1/2	1 Removable Inner Tray
TLV083	17 1/2	x 9 1/2	x 8	1 Removable Inner Tray
TLV084	17 1/2	x 9 1/2	x 8	1 Removable Inner Tray, 2 Parts Boxes, 1 Organizer
TLV085	22	x 11	x 10 1/2	1 Removable Inner Tray, 3 Organizers
TLV086	22	x 11	x 14 1/2	1 Removable Inner Tray, 3 Organizers, 2 Drawers
TLZ117	5 1/2	x 5 1/2	x 1 1/2	Parts Box



TLV082



TLV083



TLV084



TLV085



TLV086

UTILITY BOXES

- Heavy gauge steel construction
- Fully welded seams provide maximum strength
- Side handles facilitates transportation
- Diamond plate finish
- Black powder coat finish

aurora tools®

Model No.	Dimensions			Capacity	Wt.
	W"	x D"	x H"	lbs.	lbs.
TEP498	30-1/2	x 13-1/2	x 10	100	15
TEP499	45-3/8	x 15-1/4	x 15-1/8	200	35



TEP498

WATERLOO PORTABLE TOOL STORAGE SERIES

- Available in a choice of plastic and metal options
- Polyurethane portables with new design features provide additional strength



TEP471



TEP474



ATB100 PORTABLE TOOL BOXES

- Durable steel construction
- Heavy-plated latches
- Inner trays in regular hand boxes
- High gloss powder coat paint finish



TEP337



TEP338



TEP336



TEP339



TEP340



TEP516

aurora tools®

Model No.	Description	Overall Dimensions			Capacity	Wt.
		W"	x D"	x H"	lbs.	lbs.
TEP516	16" Portable Tool Box w/Metal Tool Tray	16	x 6	x 6 1/2	50	10
TEP336	21" Tool Box w/ Metal Tool Tray	21	x 8 3/4	x 9	50	12
TEP337	26" Tool Box w/ Metal Tool Tray	26	x 8 3/4	x 9	50	15
TEP338	20" Hip Roof Box w/ Metal Tool Tray	20	x 7	x 8	50	8
TEP339	21" Cantilever Tool Box	21-1/4	x 8-3/4	x 12	20	16
TEP340	21" 3-Drawer Chest	21	x 8 3/4	x 12	50	20

Model No.	Mfg No.	Description	Dimensions		
			W"	x D"	x H"
PLASTIC TOOL BOXES					
TEP471	PP-2314BK	3-Drawer Plastic Portable Chest	23	x 10 1/2	x 13 1/2
TEP473	PP-2610BK	26" Plastic Tool Box w/Tote	26	x 10 1/2	x 10
TEP474	PP-2310BK	23" Plastic Tool Box w/Tote	23	x 10 1/2	x 10
TEP475	PP-2009BK	20" Plastic Tool Box w/Tote	20	x 9 1/4	x 9
TEP476	PP-1709BK	17" Plastic Tool Box w/Tote	17	x 9 1/4	x 9
TEP477	PP-1406BK	14" Plastic Tool Box w/Tote	14	x 7 1/2	x 6 1/4
METAL TOOL BOXES					
TEP478	MP-2012BK	20" 3-Drawer Portable Chest	20	x 9	x 12

UTILITY CARTS

- Heavy-duty steel construction
- Full extension ball bearing slides on all drawers
- High quality 4" swivel casters
- Drawer capacity: 100 lbs.
- Unit capacity: 550 lbs.
- High-gloss powder coat scratch-resistant black paint



TEP483

aurora tools®

Model No.	No. of Drawers	Dimensions			Wt.
		W"	x D"	x H"	lbs.
TEP502	2	30	x 16 1/2	x 36	106
TEP483	4	33	x 18	x 39	132

TOOL STORAGE

ATB300 TOOL BOXES

- Double wall steel construction for added strength
- Full extension ball bearing slides on all drawers
- Extruded aluminum drawer handle trim
- Heavy-duty casters 5" x 2" (56" & 42") 5" x 1 1/4" (27")
- Gas struts are in the lid of 56" & 42" wide chest for ease of opening and closing
- Non-slip drawer liners
- High gloss powder coat scratch resistant paint



aurora tools

Model No.			No. of Drawers	Dimensions				Drawer Capacity lbs.	Unit Capacity lbs.	Wt. lbs.	
Red	Blue	Black		W" x D" x H"	x	x	x				
CHEST											
TEQ435	TEQ436	TEP312	4	27	x	12	x	14-1/4	75	375	41
TEQ437	TEQ438	TEP314	6	27	x	18	x	18-3/8	75	675	75
TEQ439	TEQ440	TEP316	10	42	x	18	x	18-1/4	100	1000	119
TEQ441	TEQ442	TEP318	6	56	x	23-1/2	x	18-1/4	100	720	163
TOOL CART											
TEQ443	TEQ444	TEP313	5	27	x	18-3/4	x	31-1/2	100	1400	85
TEQ445	TEQ446	TEP315	7	27	x	18-3/4	x	36	100	1400	102
TEQ447	TEQ448	TEP317	11	42	x	18-3/4	x	38-1/8	100	1400	175
TEQ449	TEQ450	TEP319	10	56	x	24-1/2	x	38-1/8	100	2100	320

ACCESSORIES FOR ATB300 & ATB400 TOOL BOXES

Model No.			Description	Dimensions			Wt. lbs.		
Red	Blue	Black		W" x D" x H"	x	x			
TEQ471	TEQ472	TEP495	2-Shelf Side Cabinet	15	x	18-3/4	x	32-3/4	43
TEQ473	TEQ474	TEP496	3-Shelf Side Cabinet	15-3/8	x	18-3/4	x	49-1/4	58
TEQ475	TEQ476	TEP497	3-Shelf Side Cabinet	15-3/8	x	24-1/2	x	49-1/4	69



TEQ435



TEP315



TEP312



TEQ450

ATB400 TOOL BOXES

- Heavy-duty double wall steel construction
- Quadra level ball bearing slides on all drawers
- Heavy-duty reinforced bottom support rails
- Heavy-duty casters 5" x 2" with double layer ball bearings
- Full extension slides for easy reach inside
- Integrated latch security drawer system prevents drawers from accidentally opening
- Heavy-duty gas struts on top lid
- High-gloss powder coat scratch-resistant blue paint
- Includes non-slip drawer liners



TEP322



TEP323

aurora tools

Model No.		No. of Drawers	Dimensions				Drawer Capacity lbs.	Unit Capacity lbs.	Wt. lbs.
No.	Drawers		W" x D" x H"	x	x	x			
CHESTS									
TEP320	4	27	x	18	x	18-7/8	120	500	74
TEP322	5	27	x	18	x	20	120	600	84
TEP324	6	42	x	18	x	19-7/8	120	700	118
TEP326	9	54	x	18	x	22-1/4	120	1000	173
TOOL CARTS									
TEP321	5	27	x	18-3/4	x	35-7/8	120	1400	111
TEP323	7	27	x	18-3/4	x	42-3/8	120	1400	135
TEP325	14	42	x	18-3/4	x	42-3/8	120	1400	221
TEP327	13	54	x	18-3/4	x	40-1/4	120	2100	264

ATB500 TOOL CHESTS

- Full extension ball bearing slides on all drawers
- Reinforced top lid
- Double wall steel construction
- High gloss powder coat scratch resistant paint
- Extruded aluminum drawer pulls
- Side carrying handles
- One year limited warranty



TEQ624



TEQ653

aurora tools

Model No.			No. of Drawers	Dimensions				Drawer Capacity lbs.	Unit Capacity lbs.	
Red	Blue	Black		W" x D" x H"	x	x	x			
TEQ620	TEQ622	TEQ621	3	27	x	12	x	14-1/4	50	250
TEQ623	TEQ625	TEQ624	3	27	x	18	x	18-3/8	50	250
TEQ626	TEQ628	TEQ627	9	27	x	18	x	20-1/4	50	400
TEQ629	TEQ631	TEQ630	4	42	x	18	x	18-1/4	75	500
TEQ632	TEQ634	TEQ633	7	42	x	18	x	18-1/4	75	500
TEQ635	TEQ637	TEQ636	7	54	x	17-7/8	x	18-3/8	75	500
TOOL CARTS										
TEQ507	TEQ642	TEQ641	3	27	x	18-3/4	x	35-3/4	75	1000
TEQ508	TEQ644	TEQ643	5	27	x	18-3/4	x	31-1/2	75	1000
TEQ638	TEQ640	TEQ639	3	27	x	18-3/4	x	30-1/4	75	1000
TEQ645	TEQ647	TEQ646	9	27	x	18-3/4	x	42-3/8	75	1000
TEQ648	TEQ650	TEQ649	5	42	x	18-3/4	x	38-1/8	75	1000
TEQ651	TEQ653	TEQ652	9	42	x	18-3/4	x	38-1/4	75	1000
TEQ654	TEQ656	TEQ655	10	54	x	18-3/4	x	38-1/8	75	1000
TEQ657	TEQ659	TEQ658	11	73	x	18-3/4	x	39	75	1500

INDUSTRIAL DUTY MOBILE SERVICE BENCHES

- Designed for moving heavy parts and tools to the job site
- Four 5" non-marking casters: two rigids and two swivels with brake
- Provides a strong maintenance-free surface to work on
- 16-gauge all-welded steel construction
- Laminated hardwood top
- Overall dimensions: 42" W x 24" D x 37"H
- Shell durable Kleton blue enamel finish
- Cabinets are powder paint grey and Kleton blue
- Shipped assembled
- Capacity: 1200 lbs. evenly distributed

KLETON



Model No.	Description	Wt. lbs.
ML325	2 Doors	235
ML326	1 Drawer/1 Door	190
ML327	4 Drawers/1 Door	275
ML328	8 Drawers	300

* Review cabinet models on page 86 to create your own mobile service bench.



ML325



ML326



ML327



ML328

TOOL TOTOER CARTS

For safe convenient storage of tools and equipment. An excellent addition to any tool centre.

- Do not waste time looking for your tools and jigs
- Each drawer is 15 1/4" x 23 3/4" x 4 3/4" with padlocking hasp
- Carrier is 18" W x 24" D x 34 1/2" H with 3" hard rubber swivel casters
- Drawer capacity: 50 lbs.
- Shipped knocked down



Model No.	Description	Wt. lbs.
FH210	2 Drawers	55
FH211	4 Drawers	85
FH212	2 Drawers and Cabinet	93

FH210



FH211



FH212



MOBILE BENCH CABINET

- Heavy duty 16 ga. all-welded steel construction
- Convenient sturdy work surface
- Back and end stops on work surface prevents parts from falling during transport
- 5" x 1-1/4" polyurethane casters (2 swivel, 2 ridged)
- Durable, textured, grey powder coat finish
- Tubular handle for ease of mobility
- Cabinet door has a 3 point locking handle with 2 keys
- 1200 lbs. capacity (based on evenly distributed weight)
- Full piano hinge on door prevents door sag
- Note: Handle adds 6" to overall width



FL634

FL637

DURHAM MFG
Est. 1922

Model No.	Workbench Type	Overall Dimensions			Cabinet Size			Drawer Dimensions		
		W"	D"	H"	W"	D"	H"	W"	D"	H"
FL634	Drawer & Cabinet	24	18	38-3/8	23-7/8	17-7/8	21-3/4	20-7/16	14-11/16	5-7/8
FL638	Drawer & Cabinet	36	18	38-3/8	36	18	16-3/8	16-1/16	14-11/16	5-7/8
FL637	Drawers & Cabinet	36	18	38-3/8	11-18	18	24-1/4	20-7/16	14-11/16	5-7/8
FL635	Shelf, Drawer & Cabinet	36	18	38-3/8	11-18	18	24-1/4	20-7/16	14-11/16	5-7/8
FL636	Shelf, Drawer & Cabinet w/Bins	36	18	38-3/8	11-18	18	24-1/4	20-7/16	14-11/16	5-7/8



FL635

SERVICE BENCHES & CABINETS

BUILD YOUR OWN MOBILE CABINET BENCHES

- Ideal for maintenance, repair and assembly departments
- Mount one, two or three cabinets from six choices of cabinets
- Heavy-duty 11-gauge steel base, 1 1/4" thick laminated hardwood top and a push handle
- Four 5" non-marking casters: two rigids and two swivels with brake
- Doors are reversible, can be opened either left or right side (factory installed hinges on right)
- All locks keyed alike by pedestal model
- Capacity: 1200 lbs. evenly distributed
- Cabinet frame powder coat finish with grey shell and Kleton blue on doors and drawers
- Shipped knocked down



KLETON

CONFIGURE YOUR OWN UNIT BY CHOOSING:

1. The pedestal style(s) that suits your needs (to a maximum of three pedestal(s))
2. Add to that the assembly kit, whether it be single, double or triple.
Assembly kit includes casters, base, handles and 1 1/4" laminated hardwood top.



Assembly Kit



FH666



FH667



FH668



FH669



FH670



FH671



FI166



FI167

1 - PEDESTAL STYLES - COMPLETE WITH LOCK AND TWO KEYS

Model No.	Description	Wt. lbs.
FH666	One Door	51
FH667	Two Half Doors	52
FH668	Two Large Drawers and One Half Door	75
FH669	Four Large Drawers	97
FH670	Four Small Drawers and One Half Door	84
FH671	Four Small Drawers and Two Large Drawers	98
FI166	Two Large Drawers	66
FI167	One Large Drawer and Two Small Drawers	78

2 - ASSEMBLY KITS

Model No.	Description	Wt. lbs.
FH407	Single	35
FH408	Double	65
FH409	Triple	95

MOBILE TOOL BOX BENCHES

- A versatile unit combining tool/storage area with a work surface
- All-welded construction, heavy-duty 11-gauge steel top and base
- Four 5" non-marking casters: two rigids and two swivels with brake
- Overall dimensions: 60" W x 22" D x 37" H
- Capacity: 1200 lbs. evenly distributed
- Durable Kleton blue enamel finish



FF993



FF994

3-DRAWER CABINETS WITH FLIP TOP PANEL COMPARTMENT

- One 22 1/8" W x 16 3/4" D x 2" H drawer
- One 22 1/8" W x 16 3/4" D x 4" H drawer
- One 26 1/2" W x 18" D x 12 3/8" H flip top compartment

5-DRAWER CABINETS

- One 22 1/8" W x 16 3/4" D x 2" H drawer
- Two 22 1/8" W x 16 3/4" D x 4" H drawers
- Two 22 1/8" W x 16 3/4" D x 6 1/8" H drawers



FF995



KLETON

Model No.	Description	Wt. lbs.
FF993	Five Drawers/Three Drawers	285
FF994	Three Drawers and Side Shelves	220
FF995	Five Drawers and Side Shelves	235

BUILD YOUR OWN CABINET WORKBENCH

- Versatile cabinet workbench suited for any industrial application that requires work surface and secure tool and parts storage
- Capacity: 1000 lbs. evenly distributed
- Durable Kleton blue enamel finish



A - CABINET SHELL ONLY

- Made of heavy gauge all-welded 14-gauge steel

Model No.	Dimensions				Wt. lbs.	
	W"	x	D"	x		H"
FH165	59	x	28	x	32	105

B - TOPS

- Our complete list of tops can be found on page B89.



Material	60" W x 30" D	72" W x 30" D	60" W x 36" D	72" W x 36" D
Blue Steel Wood Filled	FH183	FH184	FH185	FH186
Laminated Wood	FD020	FD021	FD026	FD027
Laminated Plastic	FD011	FD012	FD013	FD014
Shop Top	FD004	FD005	FD006	FD007

C - SHELVES

- Made of 14-gauge steel
- Maximum two per cabinet
- Capacity: 300 lbs.



Model No.	Dimensions			Wt. lbs.
	W"	x	D"	
FH164	58 3/4	x	27 3/4	15

D - DOORS

- Made of 18-gauge steel on rollers
- Recessed handles
- **Includes:** Plunger lock and two keys

Model No.	Description	Wt. lbs.
FH163	Door Set, Lock Included	40

E - DRAWERS

- All-welded heavy gauge steel
- 100% full extension with ball bearing slide mechanism
- All locks keyed alike by drawer model
- Aluminum extrusion handles with grey end caps
- Capacity: 100 lbs. per drawer evenly distributed
- **Includes:** Locks and two keys



Model No.	Drawer Dimensions				Wt. lbs.	
	W"	x	D"	x		H"
FH938	15 3/8	x	20	x	5 5/8	30
FH939	15 3/8	x	20	x	2 3/4	35



Kleton builds quality and dependability into all of their products!
Look throughout the catalogue for the Kleton Custom Symbol indicating which products can be custom built to meet your specifications.

BUILT KLETON TOUGH



CUSTOMIZE . . .

- Strip Curtain Doors
- Platform Trucks
- Safety Guards
- Bollards
- Gas Cylinder Cabinets
- Workbenches
- Shelf Trucks
- And more...

Call us with your specs today!

KLETON



CUSTOM WORKBENCHES

CREATE A WORKBENCH DESIGNED FOR YOUR APPLICATION

- Select from the components below to build the workbench to fit your needs
- All components required to make up your workbench are on this page
- Optional features for enhanced functionality are on the following page
- All steel components constructed of 14-gauge steel unless otherwise specified
- All mounting hardware included
- Capacities range from 1000 lbs. to 3000 lbs.
- All steel components are powder coated Kleton grey
- Shipped knocked down

A - LEGS

- Legs static or mobile
- Comes with knockout for standard two-outlet electrical plug
- Provides an overall height of 34" with top



B - TOPS

A variety of tops are available. 14-gauge steel wood filled, laminated wood, shop top and plastic laminate in a variety of sizes.

Our complete list of tops can be found on page B89.

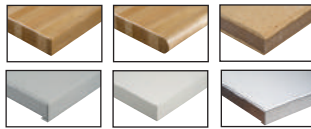

KLETON

C - UNIVERSAL STRINGERS

- Adds stability to the workbench
- Prevents legs from shifting
- Included in kits **ML266** to **ML269**
- Weight: 11 lbs.

Model No. FF979 - for 48", 60" or 72" bench

Model No. FH925 - for 84" bench

Model No. FH926 - for 96" bench



CUSTOMIZE YOUR WORKBENCH WITH ANY OF THE FOLLOWING OPTIONS

D - DRAWERS

- Add storage to any workbench
- All-welded heavy-gauge steel
- 100% full extension with ball bearing slide mechanism
- Equipped with locks and two keys
- All locks keyed alike by drawer model
- Custom key options available
- Capacity: 100 lbs. per drawer evenly distributed
- Aluminum extrusion handles with grey end caps
- Overall Dimensions: 18" W x 21" D x 9" H



SINGLE DRAWER UNITS

Model No. FH673

(1) 15 3/8" W x 20" D x 5 5/8" H



DOUBLE DRAWER UNITS

Model No. FH674

(2) 15 3/8" W x 20" D x 3 3/4" H

E - BENCH RISER SHELVES

- Increase storage space
- Ideal for getting tools and other equipment off work surfaces
- 9" D x 12" H • One per workbench

Model No.	Overall Width"	Wt. lbs.
FF956	48	19
FF957	60	24
FF958	72	29
FI319	84	35
FI320	96	42

G - BACK STOPS

- Add a 3" edge to the back of any workbench
- One per bench top

Model No.	Overall Width"	Wt. lbs.
FF704	48	8
FF705	60	10
FF708	72	12
FI317	84	14
FI318	96	16



WE TRY TO MAKE IT EASY . . .

LOOK AT OUR PRE-DESIGNED LAYOUT OPTIONS ON PAGES B90 TO B91.

Customize to your specifications. If you need specific sizes or requirements not available on this page... call your Kleton dealer with your specs today!

THINGS TO CONSIDER WHEN ORDERING A WORKBENCH

1. Determine the size (length, width, height) of the workbench required.
2. Select one of each of the required components listed on this page, respecting the determined size of the workbench.

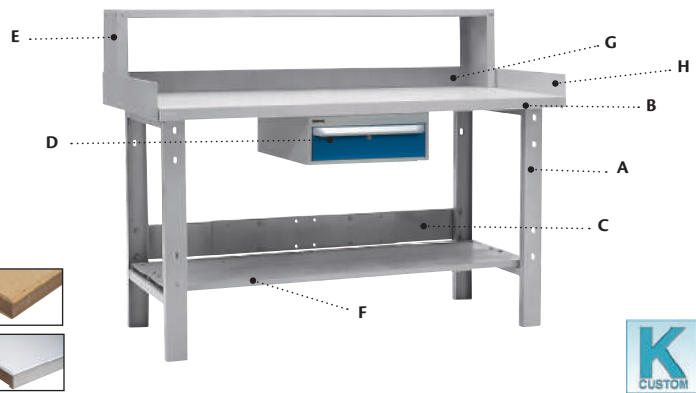

Model No.	Description	Dimensions D" x H"	Wt. lbs.
ML266*	Pair of Legs for Use w/24" D Top, Includes Stringer FF979	22 x 32	38
ML268*	Pair of Legs for Use w/30" D or 36" D Top, Includes Stringer FF979	28 x 32	45
ML264	Single Leg for Use w/24" D Top	22 x 32	14
ML265	Single Leg for Use w/30" D or 36" D Top	28 x 32	15
ML267*	Mobile Kit for Use w/24" D Top (pair), Includes Stringer FF979	22 x 32	40
ML269*	Mobile Kit for Use w/30" D or 36" D Top (pair), Includes Stringer FF979	28 x 32	40
FG732	Leg Extensions to Make Height Adjustable from 34"-39" in 1" Increments (Set of 4)	-	8

*For 84" L and 96" L tops, see Universal Stringers

F - LOWER SHELVES

- Add extra storage to any workbench
- One or two 9" deep shelves can be used per workbench

Model No.	Overall Width"	Wt. lbs.
FF934	44 (For Use with 48" Top)	14
FF935	56 (For Use with 60" Top)	16
FF936	68 (For Use with 72" Top)	18
RL866	80 (For Use with 84" Top)	21
RL867	92 (For Use with 96" Top)	24

H - END STOPS

- Add 3" sides to any workbench
- One per side desired to enclose

Model No.	Overall Depth"	Wt. lbs.
FF792	24	4
FF793	30	5
FF794	36	6

KLETON

WORKBENCH TOPS

SELECT ONE OF THESE SIX TOPS TO CUSTOMIZE YOUR WORKBENCH.

LAMINATED HARDWOOD TOPS SQUARE EDGE

- Lacquer finished tops for durability
- Heavy-duty solid hardwood laminations for long life
- Overall thickness: 1 3/4"
- 1/8" radius edge



Model No.	Size D" x W"	Wt. lbs.
FI730	24 x 48	56
FL592	24 x 60	70
FL593	24 x 72	84
FI731	24 x 84	98
FL594	24 x 96	112
FI732	24 x 120	140
FL595	30 x 48	70
FI733	30 x 60	88
FI734	30 x 72	105
FI735	30 x 84	123
FI736	30 x 96	140
FI737	30 x 120	175
FL596	36 x 48	84
FL597	36 x 60	105
FI738	36 x 72	126
FL598	36 x 84	147
FI739	36 x 96	168
FL599	36 x 120	210
FI740	48 x 48	112
FL600	48 x 60	140
FL601	48 x 72	168
FL602	48 x 84	196
FL603	48 x 96	224
FL604	48 x 120	280

Note: Tops over 36" W are shipped in two pieces of hardwood, hardware is included.

PLASTIC LAMINATE TOPS

- Light-duty top with smooth white plastic laminate face covering 45-lb. density particle board
- Overall thickness: 1 5/8"
- Colour: White



Model No.	Size D" x W"	Wt. lbs.
FD008	24 x 48	65
FD009	24 x 60	72
FH771	30 x 48	72
FD011	30 x 60	90
FD012	30 x 72	108
FH772	30 x 84	126
FH773	30 x 96	144
FH774	36 x 48	86
FD013	36 x 60	108
FD014	36 x 72	130
FH776	36 x 84	151
FH777	36 x 96	173

LAMINATED HARDWOOD TOPS BULLNOSE EDGE

- Lacquer finished tops for durability
- Heavy-duty solid hardwood laminations for long life
- Overall thickness: 1 3/4"
- 3/8" radius edge



Model No.	Size D" x W"	Wt. lbs.
FI522	24 x 48	56
FI523	24 x 60	70
FI524	24 x 72	84
FL605	24 x 84	98
FI525	24 x 96	112
FI526	24 x 120	140
FI527	30 x 48	70
FI528	30 x 60	88
FI529	30 x 72	105
FI530	30 x 84	123
FI531	30 x 96	140
FL606	30 x 120	175
FL607	36 x 48	84
FI532	36 x 60	105
FI533	36 x 72	126
FL608	36 x 84	147
FI534	36 x 96	168
FL609	36 x 120	210
FL610	48 x 48	112
FL611	48 x 60	140
FL612	48 x 72	168
FL613	48 x 84	196
FL614	48 x 96	224
FL615	48 x 120	280

Note: Tops over 36" W are shipped in two pieces of hardwood, hardware is included.

STEEL WOOD-FILLED TOPS

- Heavy-duty 14-gauge steel with formed edges
- Reinforced with wood core for sound reduction and added strength
- Overall thickness: 1 3/4"
- Colour: Powder coat Kleton grey

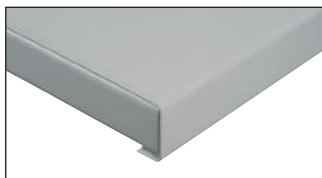

Model No.	Size D" x W"	Wt. lbs.
FD030	24 x 48	59
FD031	24 x 60	74
FH871	30 x 48	74
FD033	30 x 60	92
FD034	30 x 72	110
FH872	30 x 84	129
FH873	30 x 96	147
FH874	36 x 48	89
FD035	36 x 60	110
FD036	36 x 72	132
FH875	36 x 84	154
FH876	36 x 96	176



SHOP TOPS

- Great top for medium-duty applications
- 3/8" double sealed resin boards laminated over 1 1/8" MDF core
- Overall thickness: 1 3/4"



Model No.	Size D" x W"	Wt. lbs.
FD001	24 x 48	60
FD002	24 x 60	75
FH764	30 x 48	75
FD004	30 x 60	94
FD005	30 x 72	113
FH765	30 x 84	131
FH766	30 x 96	150
FH767	36 x 48	90
FD006	36 x 60	113
FD007	36 x 72	135
FH768	36 x 84	158
FH769	36 x 96	180

304 STAINLESS STEEL WOOD-FILLED TOPS

- Heavy-duty 14-gauge stainless steel with a number 4 finish and formed edges
- Reinforced with wood core for sound reduction and added strength
- Overall thickness: 1 3/4"

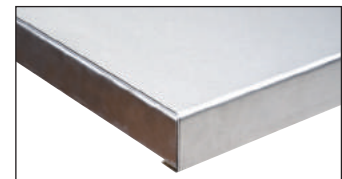

Model No.	Size D" x W"	Wt. lbs.
FI268*	24 x 48	59
FI269*	24 x 60	74
FI270*	30 x 48	74
FI271*	30 x 60	92
FI272*	30 x 72	110
FI273*	30 x 84	129
FI274*	30 x 96	147
FI275*	36 x 48	89
FI276*	36 x 60	110
FI277*	36 x 72	132
FI278*	36 x 84	154
FI279*	36 x 96	176

* Stainless Steel finish may vary

WORKBENCHES



SELECT FROM ONE OF OUR PRE-DESIGNED LAYOUT OPTIONS.
34" OVERALL HEIGHT, CAPACITY 2500 LBS. EVENLY DISTRIBUTED.



36" x 72"	36" x 60"	30" x 72"	30" x 60"	24" x 60"
STEEL - WOOD FILL				
FF672 164 lbs.	FF671 156 lbs.	FF670 166 lbs.	FF669 146 lbs.	FF667 110 lbs.
LAMINATED WOOD				
FF658 171 lbs.	FF657 149 lbs.	FF656 150 lbs.	FF655 130 lbs.	FF653 106 lbs.
SHOP TOP				
FF679 171 lbs.	FH877 157 lbs.	FF677 150 lbs.	FF676 133 lbs.	FH878 111 lbs.
PLASTIC LAMINATE				
FF665 171 lbs.	FH879 152 lbs.	FF663 150 lbs.	FF662 133 lbs.	FH880 108 lbs.



36" x 72"	36" x 60"	30" x 72"	30" x 60"	24" x 60"
STEEL - WOOD FILL				
FF707 201 lbs.	FF706 188 lbs.	FF703 203 lbs.	FF702 178 lbs.	FF700 142 lbs.
LAMINATED WOOD				
FF691 208 lbs.	FF690 181 lbs.	FF689 187 lbs.	FF688 162 lbs.	FF686 138 lbs.
SHOP TOP				
FF715 208 lbs.	FH881 189 lbs.	FF713 187 lbs.	FF712 165 lbs.	FH882 143 lbs.
PLASTIC LAMINATE				
FF698 208 lbs.	FH883 184 lbs.	FF696 187 lbs.	FF695 165 lbs.	FH884 140 lbs.



36" x 72"	36" x 60"	30" x 72"	30" x 60"	24" x 60"
STEEL - WOOD FILL				
FG293 228 lbs.	FG292 215 lbs.	FG291 230 lbs.	FG290 205 lbs.	FG289 169 lbs.
LAMINATED WOOD				
FG285 235 lbs.	FG284 208 lbs.	FG283 214 lbs.	FG282 189 lbs.	FG281 165 lbs.
SHOP TOP				
FG296 235 lbs.	FH885 216 lbs.	FG295 214 lbs.	FG294 192 lbs.	FH886 170 lbs.
PLASTIC LAMINATE				
FG288 235 lbs.	FH887 211 lbs.	FG287 214 lbs.	FG286 192 lbs.	FH888 167 lbs.



36" x 72"	36" x 60"	30" x 72"	30" x 60"	24" x 60"
STEEL - WOOD FILL				
FG109 209 lbs.	FG108 201 lbs.	FG107 211 lbs.	FG106 191 lbs.	FG104 161 lbs.
LAMINATED WOOD				
FG095 216 lbs.	FG094 194 lbs.	FG093 195 lbs.	FG092 175 lbs.	FG090 158 lbs.
SHOP TOP				
FG116 216 lbs.	FH889 202 lbs.	FG114 195 lbs.	FG113 178 lbs.	FH890 163 lbs.
PLASTIC LAMINATE				
FG102 216 lbs.	FH891 197 lbs.	FG100 195 lbs.	FG099 178 lbs.	FH892 161 lbs.



36" x 72"	36" x 60"	30" x 72"	30" x 60"	24" x 60"
STEEL - WOOD FILL				
FG277 208 lbs.	FG276 200 lbs.	FG275 210 lbs.	FG274 190 lbs.	FG273 160 lbs.
LAMINATED WOOD				
FG269 215 lbs.	FG268 194 lbs.	FG267 194 lbs.	FG266 174 lbs.	FG265 156 lbs.
SHOP TOP				
FG280 215 lbs.	FH893 201 lbs.	FG279 194 lbs.	FG278 177 lbs.	FH894 201 lbs.
PLASTIC LAMINATE				
FG272 215 lbs.	FH895 198 lbs.	FG271 194 lbs.	FG270 177 lbs.	FH896 158 lbs.



36" x 72"	36" x 60"	30" x 72"	30" x 60"	24" x 60"
STEEL - WOOD FILL				
FG640 213 lbs.	FG641 205 lbs.	FG642 215 lbs.	FG643 195 lbs.	FG644 165 lbs.
LAMINATED WOOD				
FG635 220 lbs.	FG636 198 lbs.	FG637 199 lbs.	FG638 179 lbs.	FG639 162 lbs.
SHOP TOP				
FG645 220 lbs.	FH897 205 lbs.	FG646 199 lbs.	FG647 182 lbs.	FH898 167 lbs.
PLASTIC LAMINATE				
FG648 220 lbs.	FH899 202 lbs.	FG649 199 lbs.	FG650 182 lbs.	FH900 164 lbs.



36" x 72"	36" x 60"	30" x 72"	30" x 60"	24" x 60"
STEEL - WOOD FILL				
FG245 263 lbs.	FG244 255 lbs.	FG243 265 lbs.	FG242 245 lbs.	FG241 246 lbs.
LAMINATED WOOD				
FG237 270 lbs.	FG236 248 lbs.	FG235 249 lbs.	FG234 229 lbs.	FG233 213 lbs.
SHOP TOP				
FG248 270 lbs.	FH905 256 lbs.	FG247 249 lbs.	FG246 232 lbs.	FH906 218 lbs.
PLASTIC LAMINATE				
FG240 270 lbs.	FH907 251 lbs.	FG239 249 lbs.	FG238 232 lbs.	FH908 215 lbs.



36" x 72"	36" x 60"	30" x 72"	30" x 60"	24" x 60"
STEEL - WOOD FILL				
FG137 304 lbs.	FG136 296 lbs.	FG135 306 lbs.	FG134 286 lbs.	FG132 257 lbs.
LAMINATED WOOD				
FG123 311 lbs.	FG122 289 lbs.	FG121 290 lbs.	FG120 270 lbs.	FG118 254 lbs.
SHOP TOP				
FG144 311 lbs.	FH901 297 lbs.	FG142 290 lbs.	FG141 273 lbs.	FH902 258 lbs.
PLASTIC LAMINATE				
FG130 311 lbs.	FH903 292 lbs.	FG128 290 lbs.	FG127 273 lbs.	FH904 256 lbs.



36" x 72"	36" x 60"	30" x 72"	30" x 60"	24" x 60"
STEEL - WOOD FILL				
FG229 261 lbs.	FG228 253 lbs.	FG227 263 lbs.	FG226 243 lbs.	FG225 214 lbs.
LAMINATED WOOD				
FG221 268 lbs.	FG220 246 lbs.	FG219 247 lbs.	FG218 227 lbs.	FG217 211 lbs.
SHOP TOP				
FG232 268 lbs.	FH917 254 lbs.	FG231 247 lbs.	FG230 230 lbs.	FH918 216 lbs.
PLASTIC LAMINATE				
FG224 267 lbs.	FH919 249 lbs.	FG223 247 lbs.	FG222 230 lbs.	FH920 213 lbs.



SELECT FROM ONE OF OUR PRE-DESIGNED LAYOUT OPTIONS.
34" OVERALL HEIGHT, CAPACITY 2500 LBS. EVENLY DISTRIBUTED.



36" x 72"	36" x 60"	30" x 72"	30" x 60"	24" x 60"
STEEL - WOOD FILL				
FG464 247 lbs.	FG465 239 lbs.	FG466 249 lbs.	FG467 229 lbs.	FG468 200 lbs.
LAMINATED WOOD				
FG459 254 lbs.	FG460 232 lbs.	FG461 233 lbs.	FG462 213 lbs.	FG463 197 lbs.
SHOP TOP				
FG469 240 lbs.	FH913 240 lbs.	FG470 233 lbs.	FG471 216 lbs.	FH914 202 lbs.
PLASTIC LAMINATE				
FG472 254 lbs.	FH915 235 lbs.	FG473 233 lbs.	FG474 216 lbs.	FH916 199 lbs.

36" x 72"	36" x 60"	30" x 72"	30" x 60"	24" x 60"
STEEL - WOOD FILL				
FG624 266 lbs.	FG625 258 lbs.	FG626 268 lbs.	FG627 248 lbs.	FG628 219 lbs.
LAMINATED WOOD				
FG619 273 lbs.	FG620 251 lbs.	FG621 252 lbs.	FG622 232 lbs.	FG623 216 lbs.
SHOP TOP				
FG629 271 lbs.	FH909 259 lbs.	FG630 252 lbs.	FG631 235 lbs.	FH910 221 lbs.
PLASTIC LAMINATE				
FG632 273 lbs.	FH911 254 lbs.	FG633 252 lbs.	FG634 235 lbs.	FH912 218 lbs.

36" x 72"	36" x 60"	30" x 72"	30" x 60"	24" x 60"
STEEL - WOOD FILL				
FG415 271 lbs.	FG414 263 lbs.	FG413 273 lbs.	FG412 253 lbs.	FG411 224 lbs.
LAMINATED WOOD				
FG420 278 lbs.	FG419 256 lbs.	FG418 257 lbs.	FG417 237 lbs.	FG416 221 lbs.
SHOP TOP				
FG423 278 lbs.	FH921 264 lbs.	FG422 257 lbs.	FG421 240 lbs.	FH922 226 lbs.
PLASTIC LAMINATE				
FG426 278 lbs.	FH923 259 lbs.	FG425 257 lbs.	FG424 240 lbs.	FH924 223 lbs.

EXTRA HEAVY-DUTY WORKBENCHES

ALL WELDED BENCHES

- Our most solid workbench available
- All-welded construction features a wood-filled 3/16" steel top with 11-gauge steel legs and stringers
- Mobile units come with 6" polyurethane casters, two swivel with brakes and two rigid
- Bolt-down footplates are standard
- Overall height: 34"
- Durable Kleton blue enamel finish

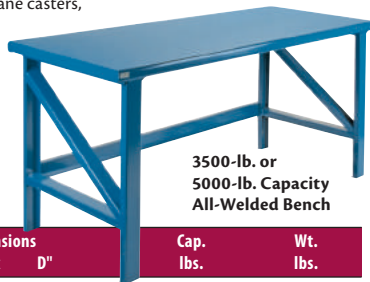

3500-lb. or
5000-lb. Capacity
All-Welded Bench

Model No.	Style	Dimensions			Cap. lbs.	Wt. lbs.
		W"	x	D"		
FF494	Static	72	x	30	5000	290
FF495	Static	72	x	36	5000	360
FH465	Mobile	72	x	30	3500	290
FH466	Mobile	72	x	36	3500	360

Other sizes available on request

HEAVY-DUTY MACHINE STANDS

- Designed for use as machinery stand or work table when full-sized workbench is not necessary
- All-welded construction, 14-gauge steel lip-down shelves, with bolt-down footplates on 3/16" x 1 1/2" angle leg
- 14" shelf clearance
- Overall height: 32"
- Durable Kleton blue enamel finish

FH269



1200-lb. Capacity
All-Welded



Model No.	Dimensions			Cap. lbs.	Wt. lbs.
	W"	x	D"		
FH268	30	x	18	1200	60
FH269	36	x	24	1200	70
FH270	48	x	24	1200	85

OPEN PEDESTAL BENCHES

- Designed for workshop applications
- Feature 1 3/4" thick solid laminated hardwood top, mounted on all-welded pedestals with two shelves
- Pedestal dimensions: 18" W x 24" D x 32" H
- Overall height: 34"
- Durable Kleton blue finish



2500-lb. Capacity
Pedestal Bench

Model No.	Dimensions			Wt. lbs.
	W"	x	D"	
FF120	60	x	30	158
FF121	72	x	30	175
FF122	84	x	30	192
FF119	120	x	30	245

* 36" deep units and/or steel tops available upon request.

ECONOMY GRADE OPEN WORKBENCHES



- Meet any strength requirement for light manufacturing, assembly operations, maintenance service, etc.
- Heavy gauge adjustable legs from 29" to 34", front and back electrical knockouts, 12" wide lower shelf
- Choose between 1" presswood top or plastic top (1 1/2" grey laminated plastic surface) widely used in electronics, laboratories, and institutions
- Capacity: 200 lbs. per sq. ft.

FH214



Optional drawer FH271
can be added to all models

Model No.	Description	Dimensions			Wt. lbs.
		W"	x	D"	
FH213	1" Presswood Top	48	x	24	70
FH214	1" Presswood Top	60	x	24	76
FH215	1" Presswood Top	72	x	24	82
FH216	1" Presswood Top	60	x	30	83
FH217	1" Presswood Top	72	x	30	92
FF649	1 1/2" Plastic Top	48	x	24	77
FF650	1 1/2" Plastic Top	60	x	24	83
FF651	1 1/2" Plastic Top	72	x	30	122
FH271	Optional Drawer Only	18	x	12	12

WORKBENCHES & WORKSTATIONS

VARI-TUFF™ ERGONOMIC WORKBENCHES

- Knocked-down, folding leg style
- Assembles in minutes
- Two brace supports and hardware supplied with each leg
- Eliminates stringers
- One package contains entire bench
- Choice of steel tops or tempered hardwood over steel (THS)
- Adjustable height from 28" to 42"
- Legs made of 13 gauge steel
- Channel formed on all four sides
- All four corners are welded and ground smooth
- 120" W unit comes with three sets of legs, all others come with two
- Capacity: 2000 lbs. evenly distributed
- Grey finish



FG750



FG753

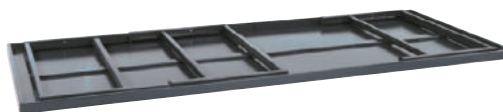

Width"	Depth"	Steel Top Model No.	THS Top Model No.
84	28	FG746	FG755
84	34	FG747	FG756
84	48	FG748	FG757
96	28	FG749	FG758
96	34	FG750	FG759
120	28	FG752	FG761
120	34	FG753	FG762
120	48	FG754	FG763

MAXI-BENCH WORKSTATIONS



FF068

- Bring your workstation to your work
- Features a sturdy 30" x 60" wood filled steel top and heavy duty all-welded 14-gauge steel frame mounted on 5" nylon non-marking casters, two rigid, two swivel (with brakes)
- Standard features: 42" high peg board panel, double drawers, swivel-out stool, lower shelf; end stops
- FF068 (shown) and FF071 include fluorescent lamp, 25' incandescent drop light, 4-outlet power bar
- Capacity: 1200 lbs. evenly distributed
- Durable Kleton blue enamel finish
- Shipped assembled



Model No.	Description	Overall Height"	Wt. lbs.
FF068	Mobile, Complete	76	435
FF069	Mobile, No Electrical	76	415
FF071	Static, Complete	70	425
FF072	Static, No Electrical	70	405

SINGLE PEDESTAL BENCHES

- Heavy gauge steel cabinet with 1" round tube frame
- Top tray lined with a rubber mat
- Full extension drawers with a capacity of 100 lbs. per drawer
- Four 4" non-marking casters with brakes for smooth, easy rolling
- Overall dimensions 20" W x 21" D x 37" H
- Capacity: 800 lbs. evenly distributed
- Cabinet frame powder coat finish with grey shell and Kleton blue on doors and drawers
- Comes complete with locks and two keys



Model No.	Description	Wt. lbs.
FF984	4-Drawer Cabinet	120
MH801	Single Door Cabinet	75

72" LOUVERED BENCH RACKS



CB176

Work bench not included

- All-welded louvered bench rack designed to be permanently installed on a 72" wide workbench
- Provides tool and storage for assembly or repair operations when combined with plastic parts bins
- 72" W x 15" D x 40" H
- Constructed of 1 1/4" square tube frame
- Durable Kleton blue enamel finish



Model No.	Description
CB364	Bench Rack Only

RACK/BIN COMBINATIONS

Red	Blue	Yellow	Bin Qty	Overall Bin Dimensions W" x D" x H"
CB173	CB172	CB174	144	4 1/8 x 7 3/8 x 3
CB176	CB175	CB177	72	5 1/2 x 10 7/8 x 5
CB185	CB184	CB186	36	8 1/4 x 14 3/8 x 7



FF984



MH801

ERGONOMIC WORKSTATIONS

- Highly functional and flexible system of above-work surface accessories and modular components
- Ergonomically designed, delivering easy accessibility with no stretch or strain
- Modular design allows for easy reconfiguration

Workstation benefits include:

- Greater productivity and efficiency
- Reduced strain and increased ergonomic ease
- Equipped to exactly suit your needs
- Properly illuminated work areas

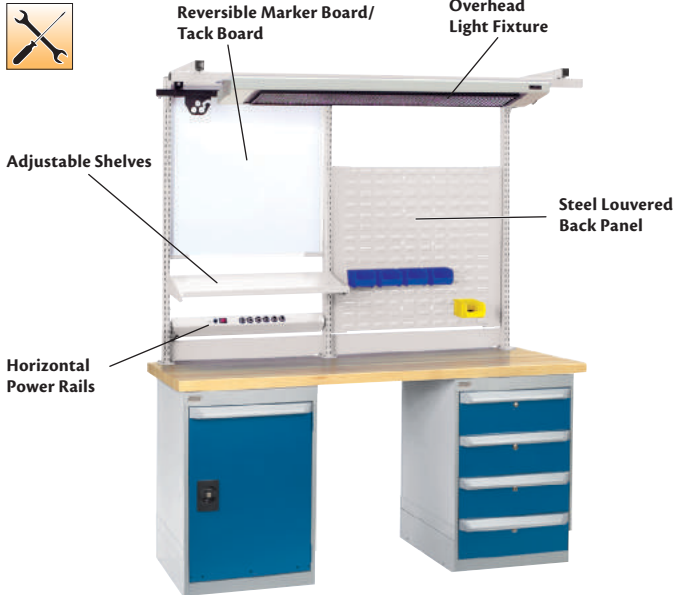

TO PICK THE RIGHT FRAME FOR YOUR NEEDS YOU MUST DETERMINE THE FOLLOWING MEASUREMENTS:

Section Width (A): Is measured from the centre of one upright to the other.

Overall Width (B): Is measured from the outside of one foot plate to the other.

Then determine if you require a single frame or double frame unit.

SURFACE MOUNT FRAMES

- Frames are made from a heavy gauge steel and are notched front and back at 1" increments
- Foot plate is 2 3/4" x 4"

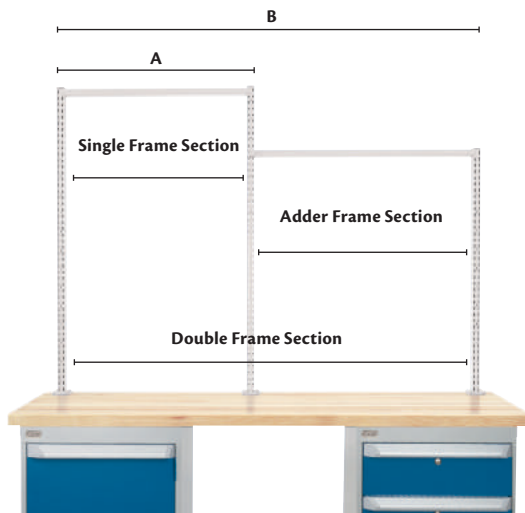

SINGLE FRAME SECTIONS

Model No.	Height"	Section Width" (A)	Min Work Surface Width" Required
FI368	30	24	30
FI370	30	30	36
FH992	30	36	42
FI372	30	42	48
FH993	30	48	54
FI374	30	60	66
FI369	48	24	30
FI371	48	30	36
FH994	48	36	42
FI373	48	42	48
FH995	48	48	54
FI375	48	60	66

ADDER FRAME SECTION

Model No.	Height"	Section Width" (A)	Min Work Surface Width" Required
FI376	30	24	54
FI378	30	30	60
FI380	30	36	66
FI382	30	42	72
FI384	30	48	78
FI386	30	60	90
FI377	48	24	54
FI379	48	30	60
FI381	48	36	66
FI383	48	42	72
FI385	48	48	78
FI387	48	60	90

DOUBLE FRAME SECTIONS

Model No.	Height"	Section Width"	Min Work Surface Width" Required
FI747	30	24 + 24	54
FI749	30	24 + 30	60
FL525	30	24 + 36	66
FL526	30	24 + 42	72
FL527	30	24 + 48	78
FL528	30	24 + 60	90
FL529	30	30 + 30	66
FL530	30	30 + 36	72
FL531	30	30 + 42	78
FL532	30	30 + 48	84
FL533	30	30 + 60	96
FL534	30	36 + 36	78
FL535	30	36 + 42	84
FL536	30	36 + 48	90
FL537	30	36 + 60	102
FL538	30	42 + 42	90
FL539	30	42 + 48	96
FL540	30	42 + 60	108
FL541	30	48 + 48	102
FL542	30	48 + 60	114
FL543	30	60 + 60	126
FI748	48	24 + 24	54
FI750	48	24 + 30	60
FL544	48	24 + 36	66
FL545	48	24 + 42	72
FL546	48	24 + 48	78
FL547	48	24 + 60	90
FL548	48	30 + 30	66
FL549	48	30 + 36	72
FL550	48	30 + 42	78
FL551	48	30 + 48	84
FL552	48	30 + 60	96
FL553	48	36 + 36	78
FL554	48	36 + 42	84
FL555	48	36 + 48	90
FL556	48	36 + 60	102
FL557	48	42 + 42	90
FL558	48	42 + 48	96
FL559	48	42 + 60	108
FL560	48	48 + 48	102
FL561	48	48 + 60	114
FL562	48	60 + 60	126

WORKBENCHES

NEXUS SYSTEM WORKBENCH ACCESSORIES

OVERHEAD CABINETS

- Protect, secure above-work-surface storage of large, bulky items



Model No.	Overall Dimensions W" x D" x H"
FI364	24 x 15 x 16
FI365	30 x 15 x 16
FI366	36 x 15 x 16
FI367	48 x 15 x 16

REPLACEMENT PARTS

FI362	Support Brackets for 16" Overall Height
-------	---

OVERHEAD LIGHT FIXTURES

- Tilts up or down 10°
- Kit includes a switch, 8' grounded electrical cord, support track, standard acrylic diffuser and T8 bulbs
- Support bracket sold separately



Model No.	Use with Frame Overall Width"
FI019	48
FI020	60

SUPPORT BRACKETS

Model No.	Use with Frame Overall Depth"
FI327	Less than 30
FI328	Greater than or equal to 30

HORIZONTAL POWER BOARDS

- 15 Amps with six plugs
- Pivots on axis providing full horizontal adjustability



Model No.	Overall Width"
FI022	24
FI023	30
FI024	36
FI025	48

VERTICAL POWER BOARDS

- 15 Amps with six outlets
- Mounts vertically to front and back of upright
- Features a lighted on/off switch, 6' cord with grounded plug and circuit breaker
- Bracket and hardware included

Model No. FI021



PLASTIC BOX RAILS

- Easily adjustable for ergonomic access
- Can be mounted either parallel or a 15° angle to the workstation
- Suitable to use with bins that have a rear lip
- Plastic bins not included



Model No.	Overall Width"
FI030	24
FI031	30
FI032	36
FI033	48

ADJUSTABLE SHELVES

- Adjustable, heavy gauge steel shelves can be mounted parallel to the work surface or at a 15° angle for easy ergonomic access
- 100-lb. capacity evenly distributed



Model No.	Overall Dimensions W" x D"
FI001	24 x 12
FI002	30 x 12
FI003	36 x 12
FI004	48 x 12
FI005	24 x 15
FI006	30 x 15
FI007	36 x 15
FI008	48 x 15
FI009	24 x 18
FI010	30 x 18
FI011	36 x 18
FI012	48 x 18

SHELF DIVIDERS

- Steel dividers fit over the edge of the shelf when it is mounted parallel to the work surface



Model No.	Overall Dimensions D" x H"
FI013	12 x 4
FI014	12 x 6
FI015	12 x 8
FI016	15 x 4
FI017	15 x 6
FI018	15 x 8

LISTA
making workspace work®

STEEL LOUVERED BACK PANELS

- Designed to accommodate industry standard plastic bins that featured louvered edge or lip

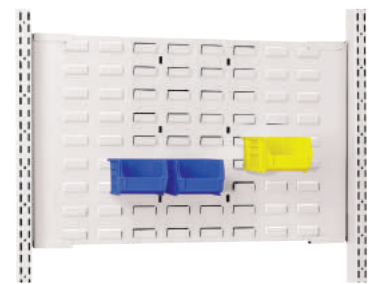

Model No.	Overall Dim. W" x H"	Model No.	Overall Dim. W" x H"
FI034	24 x 18	FI038	24 x 30
FI035	30 x 18	FI039	30 x 30
FI036	36 x 18	FI040	36 x 30
FI037	48 x 18	FI041	48 x 30

REVERSIBLE MARKERBOARDS/TACKBOARDS

- Two-sided reversible board
- Features white magnetic marker board on one side and grey fabric panel on the other



Model No.	Overall Dimensions W" x H"
FI050	24 x 30
FI051	30 x 30
FI052	36 x 30
FI053	48 x 30

STEEL PEGBOARD PANELS

- Accepts all standard pegging devices
- Holes are 1/4" in diameter

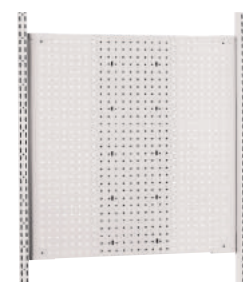

Model No.	Overall Dim. W" x H"	Model No.	Overall Dim. W" x H"
FI042	24 x 18	FI046	24 x 30
FI043	30 x 18	FI047	30 x 30
FI044	36 x 18	FI048	36 x 30
FI045	48 x 18	FI049	48 x 30

OTHER SIZES AVAILABLE UPON REQUEST

SHOP DESKS & CABINETS

WALL-MOUNTED SHOP DESK



- Durable carbon steel construction
- Ideal for areas with limited floor space
- Four compartment organizer and slightly sloped writing surface
- Easy to assemble, wall brackets included
- 23" W x 16" D x 3 1/2" H locking drawer on quiet nylon rollers
- Overall dimensions: 34 1/2" W x 28" D x 31" H
- Weight: 74 lbs.
- Grey enamel finish

Model No. FI518

OPEN FLOOR STYLE SHOP DESK



- Durable carbon steel construction
- Ideal for receiving/shipping clerks, watchmen and shop foremen
- Four compartment organizer and slightly sloped 43" height writing surface
- Optional caster kit to convert to mobile unit
- 23" W x 16" D x 3 1/2" H locking drawer on quiet nylon rollers
- Overall dimensions: 34 1/2" W x 30" D x 53" H
- Weight: 93 lbs.
- Grey enamel finish

Model No. FI519

OPTIONAL CASTER KIT

Model No. FI521

CABINET STYLE SHOP DESK



- Durable carbon steel construction
- Same features as the open floor style shop desk, with an added double door locking cabinet
- Four compartment organizer and slightly sloped 43" height writing surface
- Optional caster kit to convert to mobile unit
- 23" W x 16" D x 3 1/2" H locking drawer on quiet nylon rollers
- Overall dimensions: 34 1/2" W x 30" D x 53" H
- Weight: 146 lbs.
- Grey enamel finish

Model No. FI520

KLETON

KLETON

KLETON

SHOP DESK



- Heavy duty 16 ga. all-welded steel construction
- 18 gauge steel file drawers (2) and storage drawers (2)
- Drawers included recessed handles, ball bearing slides & cylinder locks
- Straight writing surface, 42" table top height
- An 18"D x 23"W X 7"H shelf welded on top of work surface
- Durable, textured, gray powder coat finish
- Dimensions: 39" W x 29" D x 53" H
- Colour: Grey

Model No. FL633

DURHAM MFG
Est. 1922

SHOP DESK



FG790

- Heavy duty 16 ga. all-welded steel construction
- Provides an organized work area that easily moves anywhere
- Sloped work surface has a pencil rest lip
- Drawer has ball bearing slides
- (4) 3" swivel rubber casters
- 500 lbs. overall capacity
- Dimensions: 23" W x 20" D x 51" H
- Material: Steel
- Colour: Grey

DURHAM MFG
Est. 1922

Model No.	Type
FG789	Cabinet Style
FG790	Open Style

SERVICE WRITERS



FH386



FH385

- 25 3/8" W x 16 1/2" D x 3 1/4" H locking drawer on smooth slides
- Overall dimensions: 31 1/2" W x 21" D x 72 1/2" H
- Top and bottom section are fully welded
- Powder coat tan finish
- Capacity: 200 lbs. evenly distributed

edsal

Model No.	Type
FH386	Open Style
FH385	Closed Style

DRAWER CABINETS



DRAWER CABINETS



LOCKABLE CABINETS

Safety, security, reduced shrinkage
All cabinets come with individual lock and two keys. Lock cores can be exchanged in the field for both keyed alike and master key systems

ERGONOMIC HANDLES

Improved safety, appearance and ergonomics
When drawers are closed, handles are flush with housing so nothing protrudes. Drawer handles are full width, and are located at top of drawer

HINGED LABEL HOLDERS

Easy labelling of drawer contents
Drawer handles are covered with clear hinged covers for display of drawer labels

100% FULL EXTENSION DRAWERS

Benefit: Easy access and full use of the furthest corners of storage
Continuous smooth extension even with a full load with a 400-lb. capacity

INSTALLED DRAWER DIVIDERS

Fast, accurate identification of compartment contents and easier inventory control. Angled tops allow easy identification of contents and can accommodate most bar code labels

PREVENTIP® INTERLOCK SYSTEM

Added safety and security
Unique, patented drawer locking system ensures that when one drawer is extended, all other drawers are locked closed to prevent accidental tip-over

FORK TRUCK BASE WITH FRONT AND REAR COVERS

Transport your cabinet easily from one location to another

EXCLUSIVE SUSPENSION SYSTEM

Durable, smooth, quiet operation

Lista's suspension system has been tested against the globally respected RAL-RG 614 standard. The drawers exceeded the required number of cycles at full load without diminished performance

Overall dimensions: 28 1/4" W x 28 1/2" D x 41 3/4" H
Number of drawers: 5
Number of compartments: 61
Model No. FI125 Bright Blue
Model No. FI126 Light Grey

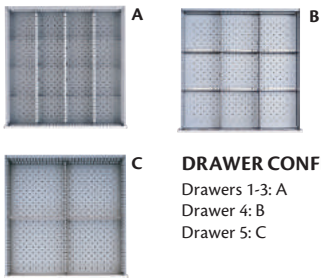

DRAWER CONFIG.

Drawers 1-3: A
Drawer 4: B
Drawer 5: C



Overall dimensions: 28 1/4" W x 28 1/2" D x 41 3/4" H
Number of drawers: 7
Number of compartments: 114
Model No. FI127 Bright Blue
Model No. FI128 Light Grey

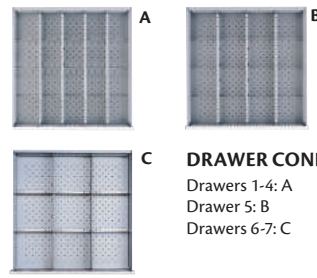

DRAWER CONFIG.

Drawers 1-4: A
Drawer 5: B
Drawers 6-7: C



Overall dimensions: 28 1/4" W x 28 1/2" D x 41 3/4" H
Number of drawers: 9
Number of compartments: 154
Model No. FI129 Bright Blue
Model No. FI130 Light Grey

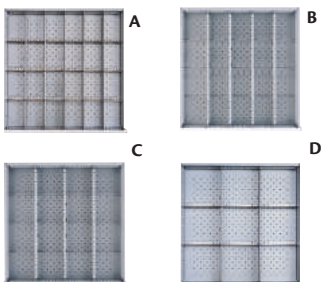

DRAWER CONFIG.

Drawers 1-2: A
Drawers 3-4: B
Drawers 5-7: C
Drawers 8-9: D

Overall dimensions: 28 1/4" W x 28 1/2" D x 41 3/4" H
Number of drawers: 10
Number of compartments: 210
Model No. FI131 Bright Blue
Model No. FI132 Light Grey

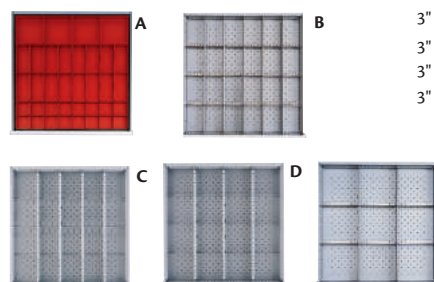

DRAWER CONFIG.

Drawers 1-2: A
Drawers 3-4: B
Drawers 5-6: C
Drawers 7-8: D
Drawers 9-10: E



Other colours available upon request

DRAWER CABINETS

Overall dimensions: 40 1/4" W x 22 1/2" D x 41 3/4" H
 Number of drawers: 5
 Number of compartments: 57
Model No. FI133 Bright Blue
Model No. FI134 Light Grey

DRAWER CONFIG.

Drawers 1-2: A
 Drawer 3: B
 Drawer 4: C
 Drawer 5: D

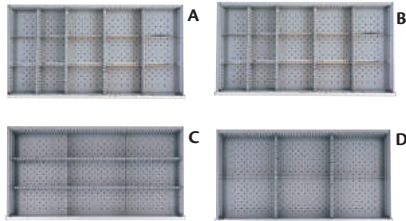

Overall dimensions: 40 1/4" W x 22 1/2" D x 41 3/4" H
 Number of drawers: 7
 Number of compartments: 96
Model No. FI135 Bright Blue
Model No. FI136 Light Grey

DRAWER CONFIG.

Drawers 1-2: A
 Drawers 3-4: B
 Drawers 5-6: C
 Drawer 7: D

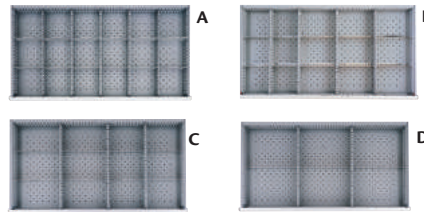

Overall dimensions: 40 1/4" W x 22 1/2" D x 41 3/4" H
 Number of drawers: 9
 Number of compartments: 117
Model No. FI137 Bright Blue
Model No. FI138 Light Grey

DRAWER CONFIG.

Drawers 1-2: A
 Drawers 3-5: B
 Drawers 6-7: C
 Drawers 8-9: D

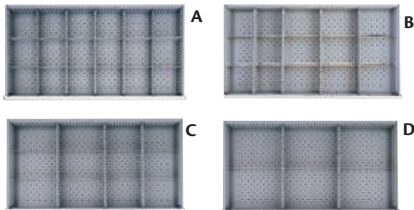

Overall dimensions: 28 1/4" W x 28 1/2" D x 59 1/2" H
 Number of drawers: 8
 Number of compartments: 88
Model No. FI139 Bright Blue
Model No. FI140 Light Grey

DRAWER CONFIG.

Drawers 1-6: A
 Drawers 7-8: B

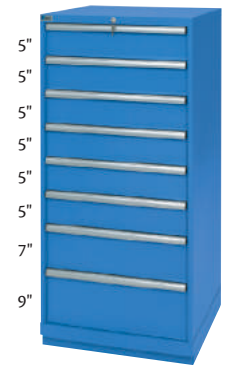
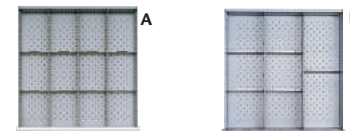

Overall dimensions: 28 1/4" W x 28 1/2" D x 59 1/2" H
 Number of drawers: 9
 Number of compartments: 124
Model No. FI141 Bright Blue
Model No. FI142 Light Grey

DRAWER CONFIG.

Drawers 1-4: A
 Drawers 5-9: B

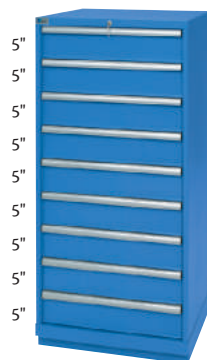
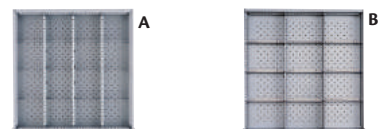

Overall dimensions: 28 1/4" W x 28 1/2" D x 59 1/2" H
 Number of drawers: 11
 Number of compartments: 172
Model No. FI143 Bright Blue
Model No. FI144 Light Grey

DRAWER CONFIG.

Drawers 1-4: A
 Drawers 5-8: B
 Drawers 9-10: C
 Drawer 11: D

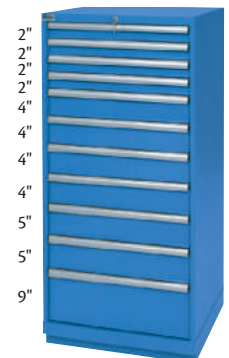
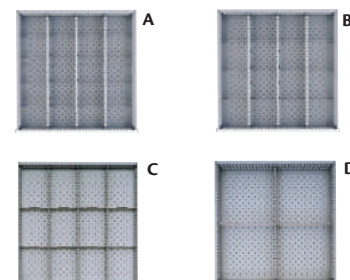

Call today for all your cabinet needs!

DRAWER CABINETS



Overall dimensions: 28 1/4" W x 28 1/2" D x 59 1/2" H
 Number of drawers: 12
 Number of compartments: 210
Model No. FI145 Bright Blue
Model No. FI146 Light Grey

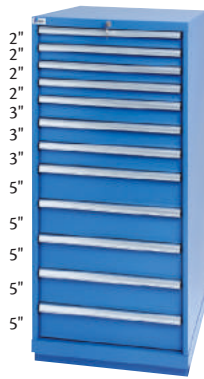
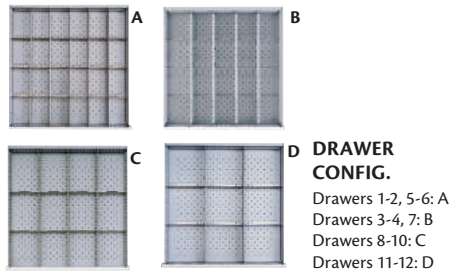

Overall dimensions: 28 1/4" W x 28 1/2" D x 59 1/2" H
 Number of drawers: 15
 Number of compartments: 300
Model No. FI147 Bright Blue
Model No. FI148 Light Grey

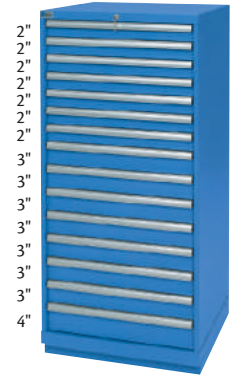
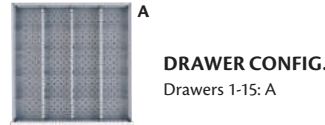

Overall dimensions: 40 1/4" W x 22 1/2" D x 59 1/2" H
 Number of drawers: 7
 Number of compartments: 66
Model No. FI149 Bright Blue
Model No. FI150 Light Grey

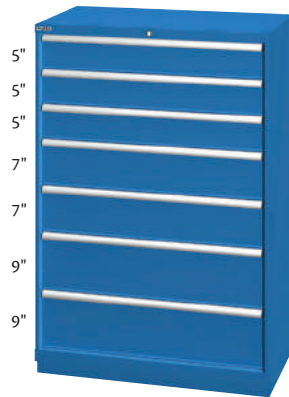
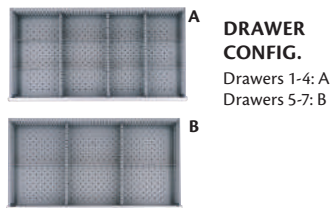

Overall dimensions: 40 1/4" W x 22 1/2" D x 59 1/2" H
 Number of drawers: 9
 Number of compartments: 105
Model No. FI151 Bright Blue
Model No. FI152 Light Grey

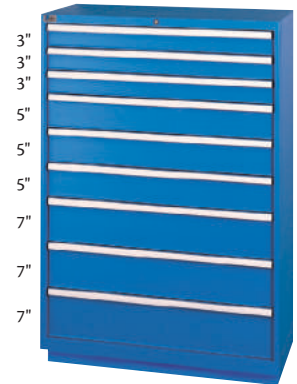
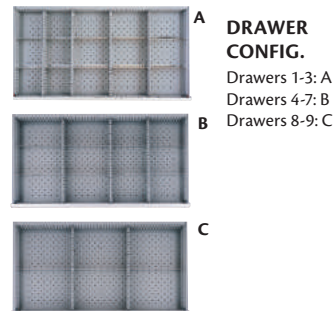

Overall dimensions: 40 1/4" W x 22 1/2" D x 59 1/2" H
 Number of drawers: 10
 Number of compartments: 159
Model No. FI153 Bright Blue
Model No. FI154 Light Grey

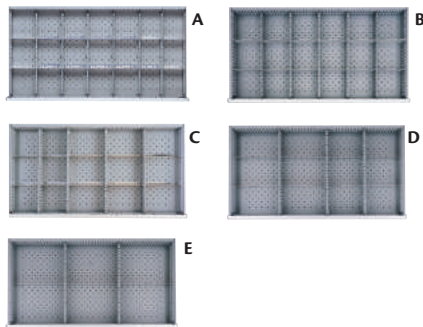

SHELF CABINETS

Overall dimensions: 56 1/2" W x 28 1/2" D x 33 1/2" H
 One fixed and one adjustable shelf
Model No. FI157 Bright Blue
Model No. FI158 Light Grey



SHELF CABINETS

Overall dimensions: 40 1/4" W x 22 1/2" D x 33 1/2" H
 One fixed and one adjustable shelf
Model No. FI159 Bright Blue
Model No. FI160 Light Grey



BUTCHER BLOCK TOPS

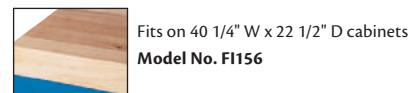
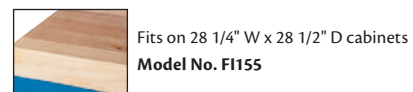



SHOP FURNITURE THAT'S BUILT LIKE A TANK!

There are times and environments that demand more than run-of-the-mill shop furniture. This is the time and place for Strong Hold. A line of shop furniture so durable and robust that it is accepted and demanded by industrial heavyweights. Major auto manufacturers use hundreds of these units!



A. FG816



B. FI331



C. FG830



D. FG836



E. FG838

A. ROUGH & TOUGH STORAGE CABINETS

These heavy-duty 12 gauge steel models provide protection for valuable tools and machine parts. Built for "rough and tough" industrial use. Shelves are adjustable and more can be added for versatility.

Model No.	Width"	Depth"	Height"	O.A. Height"	No. of Shelves	Cabinet Wt. lbs.	Extra Shelf Model No.	Shelf Capacity lbs.
FG815	36	20	72	78	4	418	FG820	1600
FG816	36	24	72	78	4	459	FG821	1900
FG817	48	24	72	78	4	557	FG822	1200
FG818	60	24	72	78	4	685	FG823	1650
FG819	72	24	72	78	4	733	FG824	1525

B. HEAVY-DUTY VENTILATED STORAGE CABINETS

The 12-gauge steel doors are perforated with a diamond shape for easy visibility and ventilation. Ideal for industry, health clubs or any facility where personal belongings need to be securely locked and ventilated.

Model No.	Width"	Depth"	Height"	O.A. Height"	No. of Shelves	Cabinet Wt. lbs.	Extra Shelf Model No.	Shelf Capacity lbs.
FI329	36	24	72	78	4	470	FG821	1900
FI330	48	24	72	78	4	548	FG822	1200
FI331	60	24	72	78	4	666	FG823	1650

C. DOUBLE SHIFT STORAGE CABINETS

These space saving cabinets provide two separate storage compartments. Companies with a second shift can secure the first shift's valuables while the second shift is on duty. Also you can use one side for personal belongings and the other to store tools.

Model No.	Width"	Depth"	Height"	O.A. Shelf Height"	Adj. Shelf Per Each Side	Cabinet Wt. lbs.	Extra Shelf Model No.	Shelf Capacity lbs.
FG829	48	24	72	78	4	624	FG832	1275
FG830	60	24	72	78	4	722	FG833	1600
FG831	72	24	72	78	4	813	FG834	1950

D. BROOM CLOSET STORAGE CABINETS

Organize your housekeeping needs with our broom closet cabinets. As heavy-duty as the rest of the Strong Hold line, double doors permit full access to all shelves. Closet side stores long handled floor care items. Use side shelves to store paper products, cleaners and brushes. Shelves can be adjusted or removed to accommodate large pails.

Model No.	Width"	Depth"	Height"	O.A. Height"	Closet Shelves	Cabinet Wt. lbs.	Extra Shelf Model No.	Shelf Capacity lbs.
FG835	36	24	72	78	4	477	FG845	1025
FG836	48	24	72	78	4	567	FG846	1375
FG837	60	24	72	78	4	669	FG847	1750

E. WARDROBE/STORAGE CABINETS

This cabinet fits into the heavy-duty line up as the answer to clothing storage with tools and supplies. 3-point latching mechanism adds extra protection.

Model No.	Width"	Depth"	Height"	O.A. Height"	Closet Shelves	Cabinet Wt. lbs.	Extra Shelf Model No.	Shelf Capacity lbs.
FG838	36	24	72	78	4	477	FG845	1100
FG839	48	24	72	78	4	567	FG846	1500
FG840	60	24	72	78	4	669	FG847	1900

CABINETS

DEEP DOOR STORAGE CABINETS

- Padlock hasp (cannot be accessed by bolt cutters) helps secure the contents of this deep door high-density storage cabinet
- Four reinforced adjustable main shelves are complemented by six adjustable mini shelves in each 4" deep hinged door for a capacity unmatched by any other cabinet
- Padlock sold separately
- Capacity per shelf: 500 lbs.



Special padlock hasp conceals padlocks from bolt cutters.

KLETON

Model No.	Description	Dimensions			Wt. lbs.
		W"	D"	H"	
FB024	Cabinet	38 x 24	72	315	
FB025	Extra Shelf for Cabinet	38 x 21 1/4	-	18	
FB026	Extra Shelf for Door	18 x 6	-	2	
SA898	Padlock Keyed Different				
SR892	Padlock Keyed Alike				

DEEP DOOR 96-BIN COMBINATION CABINETS

- All-welded heavy-duty 16-gauge combination bin/shelf cabinet
- 4" deep hinged doors
- Two reinforced 16-gauge main adjustable shelves with 500-lb. capacity per shelf
- Incorporates louvered bin hanging panels welded to the cabinet's back and doors
- Unique padlock hasp helps prevent access with bolt cutters
- Padlock sold separately
- Powder-coated Kleton grey finish
- **Bins included:**
84 each of 4 1/8" W x 5 3/8" D x 3" H
12 each of 5 1/2" W x 10 7/8" D x 5" H



KLETON

Model No.	Description	Wt. lbs.
CF371	Cabinet w/Blue Plastic Bins	359
CF372	Cabinet w/Red Plastic Bins	359
CF373	Cabinet w/Yellow Plastic Bins	359
CF374	Cabinet w/Green Plastic Bins	359

VISIBLE STORAGE WIRE MESH CABINETS

- All-welded mesh storage cabinet provides a secure yet visible area to place your tools and equipment
- Reinforced K-brace welded to the door frame delivers additional strength
- Diamond-shaped 13-gauge steel mesh
- Adjustable shelves bolt into holes
- Door has 3-point latching system with cam-lock and chrome-plated handle
- Dimensions: 24" W x 21" D x 72" H
- Weight: 146 lbs.

Model No. FB015

LYON



HEAVY GAUGE STORAGE CABINETS

- All-welded 14-gauge cabinets and shelves which can be adjusted every 3"
- Doors feature secure 3-point locking system
- 7-gauge bolt-on legs adding 4" to overall height of cabinet and provide fork lift access to move cabinet
- Capacity per shelf: 1450 lbs.



LYON

Model No.	Dimensions			No. of Shelves	Wt. lbs.
	W"	D"	H"		
FB013	36 x 21	78	4	370	
FB012	36 x 21	60	3	300	
FB011	36 x 21	42	2	230	

CLEARVIEW CABINETS

- Clear polycarbonate windows so all your tools and supplies are visible at a glance
- 12-gauge 1-piece body design
- 6" sweep space
- Adjustable 14-gauge shelves
- 3-point locking device
- Hinges are 10-gauge



Model No.	Dimensions	O.A. Height"	No. of Shelves	Shelf Cap. lbs.	Wt. lbs.
FG851	48 x 24 x 60	66	3	1200	446
FG852	48 x 24 x 72	78	4	1200	536

EXTRA HEAVY-DUTY STAINLESS STEEL CABINETS

- The strongest storage product available in the market today
- Made of 12-gauge, #304 stainless steel, with a #3 finish
- Corrosion-resistant, acid-resistant, will not rust and will take the everyday abuse in an industrial environment
- Shelves adjust on 2" centers
- 3-point locking system
- 7-gauge welded legs

These units can also be found in medical, pharmaceutical, automotive, electronics, textile, breweries, marine facilities, restaurants, etc.



Model No.	Dimensions	O.A. Height"	No. of Shelves	Shelf Cap. lbs.	Wt. lbs.	Extra Shelf Model No.
FI340	36 x 24 x 60	66	3	1900	406	FI349
FI341	36 x 20 x 72	78	4	1600	435	FI350
FI342	36 x 24 x 72	78	4	1900	475	FI349
FI343	48 x 24 x 60	66	3	1200	489	FI351
FI344	48 x 24 x 72	78	4	1200	573	FI351
FI345	60 x 24 x 60	66	3	1650	595	FI352
FI346	60 x 24 x 72	78	4	1650	699	FI352
FI347	72 x 24 x 60	66	3	1525	726	FI353
FI348	72 x 24 x 72	78	4	1525	856	FI353

COMPACT CABINETS

COUNTER HIGH CABINETS

- Raised base keeps material safe
- Easy to assemble
- No. of Shelves: 2
- Colour: Light Grey
- Sides, Back and Door Gauge: 24 ga.
- Top Gauge: 20 ga.
- Bottom Gauge: 22 ga.
- Shelf Gauge: 20 ga.
- Hinges: 2 per door
- Handle: 3-1/2" diameter recessed handle
- Meets ANSI BIFMA test standards

tensco
Storage Made Easy



Model No.	Dimensions W" x D" x H"	Shelf Capacity lbs.
FL643	36 x 18 x 42	150
EXTRA CABINET SHELF		
FL645	36 x 18 x -	150

ECONOMICAL COMPACT CABINETS

- Ideal anywhere a full sized cabinet is too large
- Includes adjustable shelves
- Locking doors
- Shipped knocked down



edra!

Model No.	Dimensions W" x D" x H"	No. of Shelves	Wt. lbs.
FH482	21 x 15 x 35	2	33
FH483	30 x 15 x 66	4	50

C-THRU COUNTER HIGH CABINET

- C-Thru cabinets are the perfect solution to view content while restricting access
- Shelf support tabs allow for easy shelf adjustment
- Three-point door locking mechanism
- Raised base keeps material safe
- Easy to assemble
- Shelf Capacity: 150 lbs.
- Sides, Back and Door Gauge: 24 ga.
- Top Gauge: 20 ga.
- Bottom Gauge: 22 ga.
- Hinges: 3 leaf hinges per door
- Handles: 2 brushed chrome handles
- Meets ANSI BIFMA test standards

tensco
Storage Made Easy



Model No.	Colour	Dimensions W" x D" x H"	No. of Shelves
FL647	Beige	36 x 18 x 42	2
FL648	Medium Grey	36 x 18 x 42	2

48" EXTRA-WIDE ALL-WELDED CABINETS

- Offers plenty of storage space for large and small supplies
- All-welded 20-gauge steel construction
- Overall dimensions: 48" W x 24" D x 72" H
- Capacity per shelf: 175 lbs. evenly distributed
- **Includes:** Four adjustable shelves and locking handle
- Fully assembled



RLB
PLUS

Model No.	Colour	Wt. lbs.
FJ860	Charcoal	230
FJ869	Beige	230
EXTRA SHELVES		
FJ921	Charcoal	175
FJ920	Beige	175

ECONOMICAL QUICK ASSEMBLY STORAGE CABINETS

- Designed for an easy assembly with fewer fasteners
- Shelves are easily adjustable on 2" centres
- 1-piece base serves as an additional shelf increasing storage capacity
- 3-point locking system, with locking chrome handle and two keys, adds security
- Capacity per shelf: 100 lbs.
- Tough grey or tan powder coat finish for durability
- Shipped knocked down



edra!

Model No.		Dimensions W" x D" x H"			Wt. lbs.
Grey	Tan	W"	D"	H"	
FH643	FH648	30	15	66	88
FH649	FH650	36	24	78	130
FH651	FH652	48	24	78	158

ALL-WELDED DEEP HI-BOY STORAGE CABINET

- Suitable for office, plant, school or institutional storage needs
- Four fully adjustable shelves
- Includes recessed handle and cylinder lock
- Shelf Capacity: 150 lbs. evenly distributed



FJ884

AGM

Model No.			Dimensions W" x D" x H"		
Black	Beige	Charcoal	W"	D"	H"
FJ882	FJ883	FJ884	36	24	72
ADDITIONAL DEEP SHELF					
FJ879	FJ880	FJ881	36	24	1

CABINETS & LOCKERS

WELDED STORAGE CABINETS

- Suitable for office, plant, school or institutional storage needs
- Fully adjustable shelves, recessed handle, cylinder lock, and coat rods (wardrobe and combination types)
- Choose from Hi-Boy, Lo-Boy, wardrobe, and combination cabinets
- Lo-Boy comes with two shelves
- Capacity: 150 lbs. evenly distributed

Hi-Boy Type



Lo-Boy Type



Wardrobe Type



Combination Type



Model No.			Description	Dimensions			Wt. lbs.
Charcoal	Beige	Black		W" x D" x H"			
FJ856	FJ864	FJ859	Hi-Boy	36 x 18 x 72	140		
FJ867	FJ871	FJ865	Wardrobe	36 x 18 x 72	182		
FJ861	FJ858	FJ862	Combination	36 x 18 x 72	121		
FJ863	FJ870	FJ868	Lo-Boy	36 x 18 x 40	112		
FJ873	FJ875	FJ876	Additional Shelf	36 x 18 x 1	-		

HEAVY-DUTY WELDED STORAGE CABINETS

- All-welded 20-gauge steel cabinet features four adjustable 18-gauge shelves, locking handle
- Shelves adjust on 2" centres
- Capacity per shelf: 300 lbs. evenly distributed
- Light grey



FJ857



Model No.	Description	Dimensions W" x D" x H"	Wt. lbs.
FJ857	Cabinet	36 x 18 x 72	185
FJ874	Additional Shelf	36 x 18 x 1	8

WELDED WALL HUNG CABINETS

- Suitable for areas where floor space is limited
- Dimensions: 36" W x 12" D x 30" H
- Includes: Fully adjustable shelf, recessed handle and cylinder lock

FJ866



Model No.	Colour	Wt. lbs.
FJ866	Charcoal	55
FJ872	Beige	55



HEAVY-DUTY CABINET DOLLIES

- Makes cabinets fully mobile
- Allows for easy access during cleaning
- Two rigid and two swivel with brake, 4" blue elastic casters
- Capacity: 800 lbs. evenly distributed



Model No.	Dimensions W" x D"	Wt. lbs.
FI292	36 x 18	32
FI293	36 x 24	33
FI294	48 x 18	34
FI295	48 x 24	36

STANDARD WELDED GEAR LOCKERS

- Gear lockers are ideal for athletic team rooms, fire fighter's equipment or any other application where easy access to uniforms and/or equipment is required
- Open face and perforated sides make these lockers fully accessible and ventilated
- Lockable safety box and foot locker allows for safely storing of valuable goods
- Lower shelf functions as a bench which eliminates the need for locker room benches
- **Base model includes:** Safety box, upper shelf and coat bar

FJ897



Model No.			Dimensions W" x D" x H"	Wt. lbs.
Light Grey	Beige	Red		
BASE MODELS				
FJ895	FJ894	FJ896	24 x 24 x 72	240
FJ901	FJ900	FJ902	30 x 24 x 72	251
FJ907	FJ906	FJ908	36 x 24 x 72	278
W/FOOT LOCKER & LOWER SHELF				
FJ898	FJ897	FJ899	24 x 24 x 72	280
FJ904	FJ903	FJ905	30 x 24 x 72	296
FJ910	FJ909	FJ911	36 x 24 x 72	328

DELUXE WELDED GEAR LOCKERS

- Deluxe gear lockers provide security with optimum ventilation for valuable equipment and uniforms
- Wardrobe design interior provides the flexibility to store all different kinds of materials and clothing
- Lower lateral drawer allows you to stow heavier bulky items such as boots or gear bags
- **Base model includes:** Three half shelves, one full width shelf, coat bar and lockable doors

FJ913



Model No.			Dimensions W" x D" x H"	Wt. lbs.
Light Grey	Beige	Red		
BASE MODELS				
FJ913	FJ912	FJ914	36 x 24 x 72	407
W/LATERAL DRAWER				
FJ916	FJ915	FJ917	36 x 24 x 72	527

READY TO ASSEMBLE STEEL LOCKERS

- Ships knocked down, ready to assemble with nuts and bolts included
- 16-gauge frames, 24-gauge body and shelves
- Durable powder-coated grey paint finish
- Number plates available separately
- Single tier dimensions: 12" W x 18" D x 72" H
- Double tier door height: 33 1/4"
- Lockerettes door height: 11"

KLETON



Three zinc-plated coat hooks and one shelf included with single and double tier lockers



Stainless steel recessed padlock handles
Magnetic latch ensures door is properly fastened when closed



Double pan construction doors, 20-gauge outer and 24-gauge inner pans (single & double tier)



16-gauge frames, 24-gauge body and shelves



SLOPE TOP

- Helps eliminate dust build up
- Raises top by 10"



RECESSED BASE

- Prevents liquids from entering the locker
- Raises locker 4" off the ground



ACCESSORIES

Model No.	Description
FL375	10" Slope Top
FL374	4" Recessed Base
FL376	Nuts & Bolts, Set of 1
FL518	Number Plates (Set of 1 to 25)
FL519	Number Plates (Set of 26 to 50)
FL520	Number Plates (Set of 51 to 75)
FL521	Number Plates (Set of 76 to 100)

SINGLE TIER

Model No.	Bank of	Wt. lbs.
BASIC STYLE		
FL362	1	52
FL363	2	96
FL364	3	139
W/SLOPE TOP		
FL380	1	56
FL381	2	104
FL382	3	151
W/RECESSED BASE		
FL392	1	56
FL393	2	104
FL394	3	151
W/SLOPE TOP & RECESSED BASE		
FL404	1	60
FL405	2	112
FL406	3	163

DOUBLE TIER

Model No.	Bank of	Wt. lbs.
BASIC STYLE		
FL366	1	54
FL367	2	98
FL368	3	141
W/SLOPE TOP		
FL384	1	57
FL385	2	106
FL386	3	153
W/RECESSED BASE		
FL396	1	57
FL397	2	106
FL398	3	153
W/SLOPE TOP & RECESSED BASE		
FL408	1	61
FL409	2	114
FL410	3	165

LOCKERETTES

Model No.	Bank of	Wt. lbs.
BASIC STYLE		
FL370	1	56
FL371	2	112
FL372	3	168
W/SLOPE TOP		
FL388	1	60
FL389	2	120
FL390	3	180
W/RECESSED BASE		
FL400	1	60
FL401	2	120
FL402	3	180
W/SLOPE TOP & RECESSED BASE		
FL412	1	64
FL413	2	128
FL414	3	192

LOCKERS

CLEAN LINE™ ECONOMY LOCKERS

- Fully assembled, prime grade cold rolled steel locker
- All-welded frame with panels and doors assembled with pop rivets
- 20-gauge double pan construction doors, 16-gauge frames, 24-gauge bodies and shelves
- Dimensions: 12" W x 18" D x 72" H
- **Single tier locker includes:**
One hat shelf, three coat hooks and aluminum recessed padlock handle
- **Double and Triple lockers include:**
Two coat hooks per opening and aluminum recessed padlock handle
- High quality baked on enamel standard pearl grey paint (beige also available)

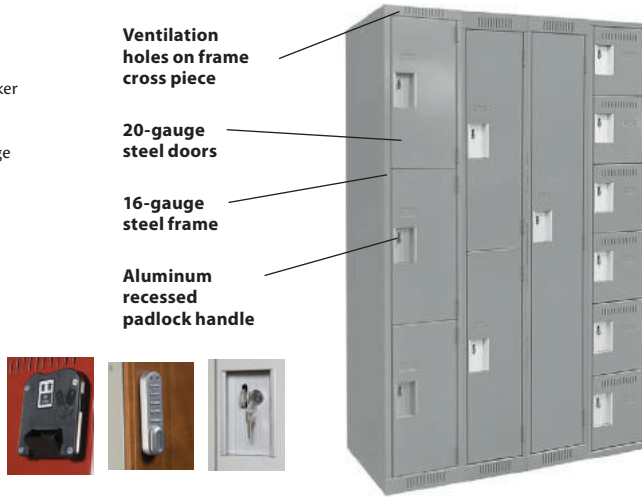

Bank of 1

Bank of 2

Bank of 3

Bank of 4



SLOPE TOP

Slope top prevents the collection of debris and is easier to maintain against the accumulation of dust



RECESSED BASE

Raises locker 4" off the floor



SINGLE TIER LOCKERS

Model No.	Bank of
BASIC STYLE	
FJ151	1
FJ152	2
FJ153	3
FJ154	4
W/SLOPE TOP	
FJ176	1
FJ177	2
FJ178	3
FJ179	4
W/RECESSED BASE	
FJ224	1
FJ225	2
FJ226	3
FJ227	4
W/RECESSED BASE & SLOPE	
FJ200	1
FJ201	2
FJ202	3
FJ203	4
W/PERFORATED DOORS	
FJ478	1
FJ479	2
FJ480	3
FJ481	4

DOUBLE TIER LOCKERS

Model No.	Bank of
BASIC STYLE	
FJ155	1
FJ156	2
FJ157	3
FJ158	4
W/SLOPE TOP	
FJ180	1
FJ181	2
FJ182	3
FJ183	4
W/RECESSED BASE	
FJ228	1
FJ229	2
FJ230	3
FJ231	4
W/RECESSED BASE & SLOPE	
FJ204	1
FJ205	2
FJ206	3
FJ207	4
W/PERFORATED DOORS	
FJ482	1
FJ483	2
FJ484	3
FJ485	4

TRIPLE TIER LOCKERS

Model No.	Bank of
BASIC STYLE	
FJ159	1
FJ160	2
FJ161	3
FJ162	4
W/RECESSED BASE & SLOPE	
FJ208	1
FJ209	2
FJ210	3
FJ211	4
W/PERFORATED DOORS	
FJ486	1
FJ487	2
FJ488	3
FJ489	4

FREE STANDING BASE

- Ideal for making the underneath of your lockers accessible for cleaning
- Overall height of 6"
- Constructed of 16-gauge steel legs and frame
- Grey

Model No.	For Bank of	Dimensions
FJ931	1	12" W x 18" D x 6" H
FJ932	2	24" W x 18" D x 6" H
FJ933	3	36" W x 18" D x 6" H
FJ934	4	48" W x 18" D x 6" H

LOCKERETTES

Model No.	Bank of
BASIC STYLE	
FJ171	1
FJ172	2
FJ173	3
FJ174	4
W/PERFORATED DOORS	
FJ490	1
FJ491	2
FJ492	3
FJ353	4

ACCESSORIES

Model No.	Description
FJ930	Cylinder Lock
FJ685	Coat Rod
FL587	Locker Number Plates 1-25
FL588	Locker Number Plates 26-50
FL589	Locker Number Plates 51-75
FL590	Locker Number Plates 76-100



FJ931

ALL-WELDED CONCORDE™ LOCKERS

- All-welded heavy-duty cold-rolled steel construction
- Dimensions: 12" W x 18" D x 72" H
- 16-gauge door frame
- 20-gauge double wall door with ventilation
- 11-gauge hasp with easy padlock accessibility
- **Single tier lockers include:**
 - One hat shelf and three coat hangers
- **Double and triple lockers include**
 - two coat hooks per opening
 - Coat hoots are rounded and polished to avoid damage to clothing
 - Magnetic latch for secure door closing
 - Contemporary style ventilated louvers at top and bottom of each door (12 holes of 1" x 1/4")
- High quality baked on enamel charcoal grey paint (light grey and beige also available)

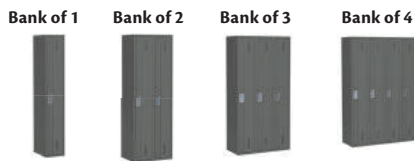

Magnet in door strike ensures doors will remain closed

Full length handle

Incorporated ventilation on the doors

20-gauge double panelled door

14-gauge hinge

22-gauge galvanized steel bottom



PERFIX.CA

Type	Bank of 1 Model No.	Wt. lbs.	Bank of 2 Model No.	Wt. lbs.	Bank of 3 Model No.	Wt. lbs.	Bank of 4 Model No.	Wt. lbs.
SINGLE LOCKERS								
Basic	FJ783	64	FJ784	119	FJ785	174	FJ786	229
DOUBLE LOCKERS								
Basic	FJ799	65	FJ800	121	FJ801	176	FJ802	231
TRIPLE LOCKERS								
Basic	FJ815	66	FJ816	122	FJ817	178	FJ818	233
LOCKERETTES								
Basic	FK872	64	FK873	119	FK874	174	FK883	229

Slope tops and recessed base options also available

16-DOOR ARCHETTES

- Ideal for confined spaces
- 16 lockable compartments
- Bar for hanging garments
- Compartment dimensions 12" W x 18" D x 12" H
- Overall dimensions: 72" W x 18" D x 72" H
- Padlock hasp
- Assembly required



Model No.	Description	Colour	Wt.lbs.
FJ175	Pop Rivet Assembled	Light Grey	165
FL359	All-Welded	Light Grey	180
FL360	All-Welded	Charcoal	180

PLASTIC LOCKERS

A NEW GENERATION OF LOCKERS

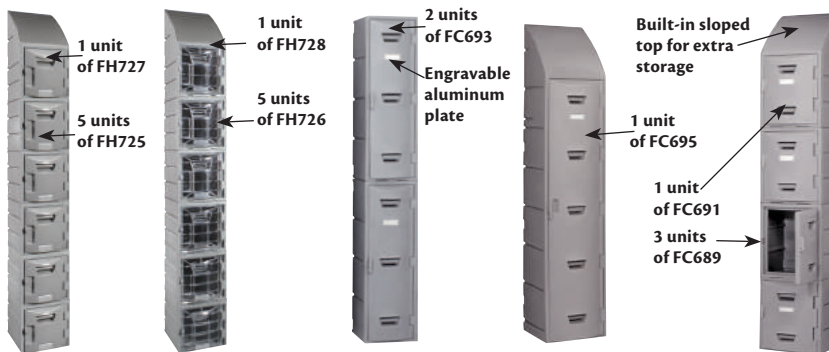

- These plastic lockers are maintenance-free
- Drain holes make them easy to clean, just hose them down with soap and water
- Durable plastic construction makes them perfect for wet environments: food processing plants, athletic facilities, etc.
- Optional clear door design allows for easy inspection locker contents

SPECIFICATIONS:

- Rust-proof
- No need for painting
- Easy Cleaning
- Maintenance-free
- Durable polyethylene construction
- Each unit is fully assembled
- Easy installation
- Space saving design

Model No.	Description	Dimensions			Hook	Shelf	Top	Door Colour	Wt. lbs.
		W"	x	D"					
FH725	12"H Locker (Usually Stacked 6 units high)	12	x	15	No	No	Flat	Grey	6
FH726	12"H Locker (Usually Stacked 6 units high)	12	x	15	No	No	Flat	Clear	6
FH727	12"H Locker	12	x	15	No	No	Slope	Grey	8
FH728	12"H Locker	12	x	15	No	No	Slope	Clear	8
FC689	18"H Locker (Usually Stacked 4 units high)	15	x	15	No	No	Flat	Grey	10
FC691	18"H Locker	15	x	15	No	No	Slope	Grey	45
FC693	36"H Locker (Usually Stacked 2 units high)	12	x	15	Yes	No	Flat	Grey	16
FH729	36"H Locker	12	x	15	Yes	No	Slope	Grey	18
FC695	Full Size 60"H Locker	15	x	18	Yes	Yes	Slope	Grey	42

All dimensions and weight are nominal and may vary due to molding tolerances. Mounting hardware not included

WALL HUNG LOCKERS

- All-in-one storage for clothing and personal effects
- Four compartments measuring 12" W x 18" D x 12" H
- Baked enamel grey finish



Model No.	Description	Colour
FJ919	Pop Rivet Assembled	Light Grey
FL357	All-Welded	Light Grey
FL358	All-Welded	Charcoal

LOCKER ROOM BENCHES

- Necessary for any locker room
- 18 gauge all-welded steel
- Wood top benches feature black powder coated legs that can be used free-standing or bolted to the floor



Model No.	Type	Dimensions			Wt. lbs.		
		L"	W"	H"			
FB002	Steel	72	x	12	x	17	35
RL871	Wood	48	x	9 1/2	x	16 1/2	23
RL872	Wood	60	x	9 1/2	x	16 1/2	29
RL873	Wood	72	x	9 1/2	x	16 1/2	31
RL874	Wood	96	x	9 1/2	x	16 1/2	39

RACKING

PRONTO BULK STORAGE RACKS

- Up to 2000-lb. capacity per shelf
- Starter unit includes two all-welded end frames, and three 5/8" presswood shelves flush-fitted into positive locking steel shelf beams (two per shelf)
- Add-on units include only one end frame
- Additional shelves may be added into any unit at 4" vertical centres
- For extra stability and rigidity, all units feature three safety bars per shelf
- Blue enamel finish
- Rack only units (no wood shelves) are available upon inquiry

Note: Not recommended for powered lift truck applications.

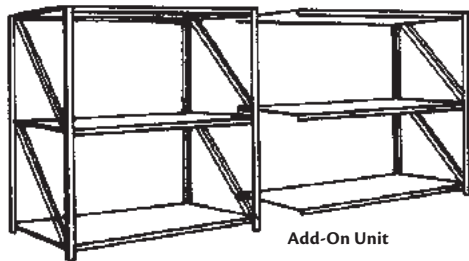

Starter Unit

Add-On Unit

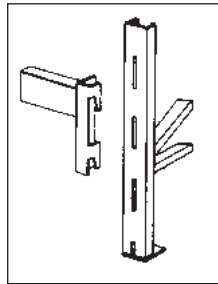

Assembles quickly without bolts



Dim. W' x H'	Description	Cap. lbs.	24" SHELF DEPTH		36" SHELF DEPTH		48" SHELF DEPTH	
			Model No.	Wt. lbs.	Model No.	Wt. lbs.	Model No.	Wt. lbs.
7 x 8	Starter	1400	RA443	245	RA475	288	RA507	331
7 x 8	Add-on	1400	RA441	217	RA473	258	RA505	299
7 W	Add'l shelf	1400	RA470	63	RA502	76	RA534	89
8 x 10	Starter	2000	RA453	302	RA485	351	RA517	400
8 x 10	Add-on	2000	RA451	268	RA483	315	RA515	362
8 W	Add'l shelf	2000	RA471	78	RA503	93	RA535	108
8 x 12	Starter	2000	RA463	316	RA495	365	RA527	414
8 x 12	Add-on	2000	RA461	275	RA493	322	RA525	369
8 W	Add'l shelf	2000	RA471	78	RA503	93	RA535	108

BULK STORAGE RACKS

- Ideal solution for storage of large and bulky items
- Designed to work without nuts and bolts which allows for assembly in minutes
- Shelves are adjustable among 1 1/2" increments
- Optional particle board deck panels combine economy and strength and are easy to install
- Units come standard with sturdy 84" high, 14-gauge posts and left to right beams as well as 16-gauge front to back beams
- Double riveted beams lock into corner posts to eliminate back and side sway
- Durable baked gray enamel finish to resist rust and corrosion
- Shipped knocked down



Easy assembly: Only a mallet is needed

Dimensions W" x D" x H"	Shelf Cap. lbs.	3 Levels		4 Levels		Particle Board Deck	
		Model No.	Wt. lbs.	Model No.	Wt. lbs.	Model No.	Wt. lbs.
48 x 24 x 84	1200	RL124	62	RL139	74	RL154	20
48 x 36 x 84	1200	RL125	68	RL140	82	RL155	29
48 x 48 x 84	1200	RL126	74	RL141	90	RL156	39
60 x 24 x 84	1000	RL127	72	RL142	88	RK016	25
60 x 36 x 84	1000	RL128	78	RL143	96	RK019	37
60 x 48 x 84	1000	RL129	84	RL144	104	RL157	49
72 x 24 x 84	750	RL130	74	RL145	90	RK017	29
72 x 36 x 84	750	RL131	80	RL146	98	RK020	44
72 x 48 x 84	750	RL132	86	RL147	106	RL158	59
96 x 24 x 84	600	RL133	86	RL148	106	RK018	39
96 x 36 x 84	600	RL134	92	RL149	114	RK021	59
96 x 48 x 84	600	RL135	98	RL150	122	RL159	78
96 x 24 x 84	800	RL136	98	RL151	122	RK018	39
96 x 36 x 84	800	RL137	104	RL152	130	RK021	59
96 x 48 x 84	800	RL138	110	RL153	138	RL159	78



RACKING

CENTENNIAL PROFILE ACCESSORIES

FLUSH SAFETY BARS FOR BOX BEAMS

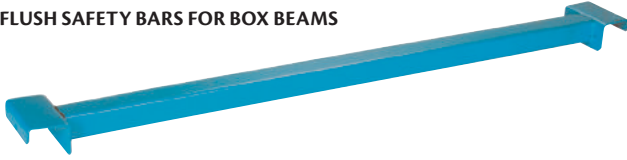

Model No.	Dimensions			Wt. Cap. lbs.
	W"	x	L"	
RB878	2	x	42	1100
RB884	6	x	42	1200
RB872	12	x	42	1200

DRUM CRADLES

- For positive positioning of cylindrical containers
- Unit fits onto cross bars and provides wedge type security



Model No.	Description
RB847	Drum Cradle (Type II - 36")
RB848	Drum Cradle (Type II - 42")

SKID CHANNELS

- For use with legged skids
- Fits across beams, from front to rear
- Recessed channel provides support for skid legs



Model No.	Dimensions		
	W"	x	L"
RB920	6	x	24
RB921	6	x	30
RB922	6	x	36
RB923	6	x	42
RB924	6	x	48
RB918	12	x	42

WALL CONNECTORS

- Wall connectors are used to provide a tie between racking and the wall
- Plate is punched to allow lagging



Model No.	Dimensions"
RB835	6
RB830	12

ROW CONNECTORS

- Row connectors are used on back to back racking layouts to maintain spacing between rows
- May be located at any level other than where a stringer is located



Model No.	Dimensions"
RB327	6
RB328	8
RB322	12

WIRE DECKING

- Easy to install
- Step/Waterfall style
- Three channels sit on the beam to carry the load
- Capacity: 2500 lbs.
- Grey

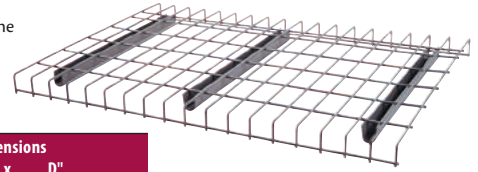

Model No.	Dimensions		
	W"	x	D"
RL379	46	x	42
RL380	52	x	42
RL377	46	x	36
RL378	52	x	36

PALLET RACK BACK GUARDS

Back guards help prevent accidents by keeping pallets and their contents from falling off the back of the rack. These guards increase safety where pedestrian pathways are behind the rack.

- Constructed using a 10-gauge frame, and 2" x 2", 10-gauge wire mesh with stiffeners
- Available in a variety of sizes to fit most pallet rack configurations
- Guard brackets are designed to fit almost any style of rack
- Durable safety yellow finish
- Hardware not included

KH131



ML231



KLETON

Create a pallet rack back guard designed for your application

1. Choose one or a combination of back guard panels to create the required width and length

Model No.	Dimensions'	Weight lbs.
KH926	1 x 4	10
KH914	2 x 4	12
KH930	3 x 4	20
KD130	4 x 4	23
KD131	8 x 4	45

2. Choose a mounting bracket that provides the required depth
 - Minimum of four brackets required

Model No.	Dimensions"	Weight lbs.
ML231	4 x 6	2
ML232	4 x 9	2
ML233	4 x 12	3

3. Hardware required

- For each additional panel, add: 2 x MMB721 and 2 x MMH254
 For each mounting bracket, add: 3 x MMP624 and 3 x MMB721

For our complete line of labels & label holders

ALH
ALIGNER LABEL HOLDER

See page B119



BAR STORAGE RACKS

All-steel vertical and horizontal racks are ideal for storing bars, tubes, pipes and angles. Economical knocked-down design reduces storage and shipping costs.

COMBINATION VERTICAL RACKS

- Stores bars up to 12' long and features three shelves for extra storage of small parts
- 8" deep arms divided into three sections
- Overall dimensions: 36" W x 24" D x 84" H
- Capacity: 3000 lbs.
- Durable Kleton blue enamel finish
- Weight: 128 lbs.

Model No. RL922

RB958



KLETON

KLETON

HORIZONTAL BAR RACKS

- Stores bars up to 10' long
- 9" deep arms with nine storage levels at 6" intervals
- Overall dimensions: 18" W x 40" D x 84" H
- Capacity: 1200 lbs.
- Durable Kleton blue enamel finish
- Weight: 68 lbs.

Model No. RB958

VERTICAL BAR RACKS

- All-welded steel construction
- Vertically stores bars up to 10' long
- Four 24" deep dividers
- Overall dimensions: 48" W x 24" D x 60" H
- Capacity: 3000 lbs.
- Durable Kleton blue enamel finish
- Weight: 100 lbs.

Model No. RL383



RL383



KLETON

KLETON

MOBILE PIPE & BAR RACK

- All-welded steel construction, ready to use
- 3 double sided storage levels with 7" high uprights to secure load
- Useable space per side 6"-11"-15" (top-middle-bottom)
- Durable Kleton blue enamel finish
- Capacity is based on evenly distributed weight
- Capacity: 3000 lbs.
- Wheel Material: Polyurethane



KLETON

Model No.	Overall Dim.			Wt. lbs.
	W"	D"	H"	
M0248	48	36	60	205
M0249	72	36	60	245

STANDARD VERTICAL SHEET RACKS

- All-welded steel construction
- Designed for vertically storing sheet goods
- Constructed of heavy gauge steel 1 1/4" tube for bays and a heavy gauge steel 1" x 2" rectangular tube for the frame
- Each bay can hold up to 1000 lbs.
- Capacity: 4000 lbs.
- Durable Kleton blue enamel finish

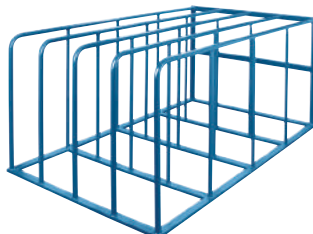

KLETON

KLETON

Model No.	Overall Dim. W" x D" x H"	Number of Bays	Distance Between Bays"	Wt. lbs.
RL384	84 x 50 x 36	4	10	200

CANTILEVER BAR-STOCK RACKING

LIGHT-DUTY

- All-welded components assemble easily
- Seven 12" adjustable arms per column side
- Capacity per arm: 1000 lbs.
- 36" W x 18 1/4" D x 75" H
- Shipped knocked down



REGULAR-DUTY

- Ideal for storing of steel, iron, aluminum, wood or plastic pipe
- All-welded components assemble easily
- Seven 14" adjustable arms per column side
- Capacity per arm: 2000 lbs.
- 36" W or 72" W x 21" D x 84" H
- Shipped knocked down

LIGHT-DUTY

Model No.	Description	Capacity lbs. /Unit	Wt. lbs.
RL730	Single-Sided	7000	306
RL731	Double-Sided	14 000	434

REGULAR-DUTY

Model No.	Description	Width"	Capacity lbs. /Unit	Wt. lbs.
STARTER				
RL732	Single-Sided	36	14 000	315
RL734	Double-Sided	36	28 000	452
RL736	Single-Sided	72	14 000	329
RL738	Double-Sided	72	28 000	466
ADD-ON				
RL733	Single-Sided	36	7000	168
RL735	Double-Sided	36	14 000	236
RL737	Single-Sided	72	7000	182
RL739	Double-Sided	72	14 000	250

For capacities to be validated, units must be anchored to slab using a minimum of two 1/2" x 3 3/4" wedge anchors per column (MLA725)

THREADED ROD RACKS

- Eighteen 2 1/8" diameter openings
- Overall dimensions: 24 1/8" W x 6 7/8" D x 24" H
- Weight: 16 lbs.
- Grey
- All Welded

Model No. CB578

DURHAM MFG
Est. 1922



HORIZONTAL SHEET RACKS

- Designed for storage of sheet materials
- Flat storage fully supports materials and reduces warping
- Sheets are accessible from all four sides
- All-welded construction and the frame is made of 2" square tubing
- Five shelf design creates four storage bays spaced 9 1/2" apart and a open top bay
- Bay Capacity: 2000 lbs. evenly distributed
- Maximum rack capacity: 8000 lbs.

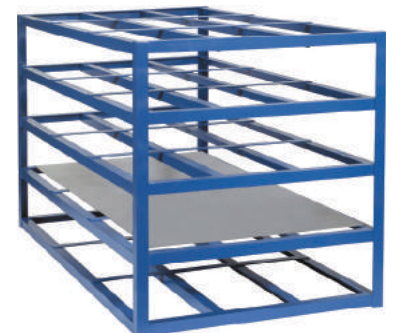

KLETON

KLETON

Model No.	Overall Dim. L" x W" x H"	Number of Shelves	Net Wt. lbs.
RL923	103 x 55 x 48	5	575

PALLETS

NESTABLE EXPORT PALLET

- Economic, environmental and efficient alternative to wood pallets
- 100% recyclable export pallet
- Low cost lightweight pallet ideal for export and one way shipments
- Flow thru design allows for easy cleaning
- Pallet Entry: 4-Way
- ISPM 15 exempt



Model No.	Dimensions			Capacity lbs.		Wt. lbs.
	L" x W" x H"	Static	Dynamic			
MN725	48 x 40 x 5.75	15000	2750	23.4		

LIGHT DUTY EXPORT PALLETS

- Low cost lightweight alternative to wood pallets
- Made of 100% recycled plastics and completely recyclable
- These low cost, single use pallets are designed for export oriented companies
- Pallets are nestable for easy storing and space saving
- 4-way entry for both forklift and pallet truck
- Streamlines customs process and reduces shipping delays
- ISPM 15 exempt
- Should only be used and stored in dry environments
- Can't be in contact with any form of liquid (e.g. water)

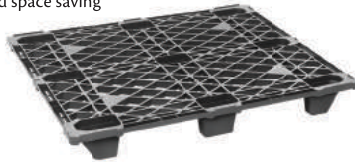

Model No.	Dimensions			Capacity lbs.		Wt. lbs.
	L" x W" x H"	Static	Dynamic			
MN457	48 x 40 x 5.2	3500	1500	12.5		

RACKSTAR II PALLETS

- Highly impact resistant design
- 100% recyclable with fully removable reinforcement structure
- Solid wall design for increased durability
- 4-way forklift accessible
- Easy to sanitize
- Removable/repairable stringers or full frame bottom, with easy-to-replace fasteners, are available for added capacity in forklift and conveyor use
- Rackable
- ISPM 15 exempt

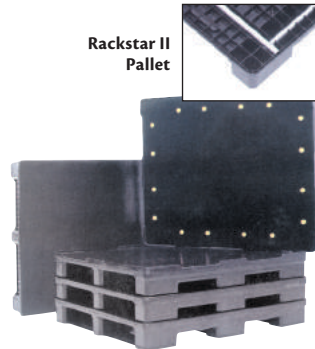

Model No.	Description	Dim. L" x W"	Capacity lbs.		Decking	Capacity lbs. Centre Supports	Edge Supported	Wt. lbs.
			Static	Dynamic				
CC163	w/o Lip (Includes 16 Deck Grommets)	48 x 40	30000	6000	6000	6000	3000	56.6

MEDIUM-DUTY RACKABLE PLASTIC PALLETS

- Unique rib design for easy cleaning and sanitary applications
- Edge-supported racking application, maximum capacity of 1400 lbs.
- Bottom design of pallet ideal for automated conveying
- Anti-skid grommets on both top and bottom
- High pressure injection molded plastic pallets made with recyclable materials
- Grey
- ISPM 15 exempt

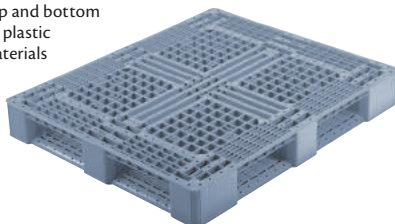

Model No.	Dimensions			Capacity lbs.		Wt. lbs.
	L" x W" x H"	Static	Dynamic			
MN172	48 x 40 x 6	30000	3000	42		

REUSABLE NESTABLE PALLETS

- Nestable pallet designed for long life
- Choice of two popular small footprint pallets
- 100% recyclable and reusable pallet with long service life
- Economic, environmental and efficient alternative to wood pallets
- 2-way entry for forklift and hand pallet trucks
- ISPM 15 exempt



Model No.	Dimensions			Capacity lbs.		Wt. lbs.
	L" x W" x H"	Static	Dynamic			
CB518	28 x 20 x 5.3	5000	1500	9.4		
CB519	40 x 28 x 5.3	10000	2000	18.9		

NESTABLE SINGLE-FACED PALLETS

- 1-piece structural foam pallets are lightweight, nestable and recyclable
- High-density polyethylene construction
- Large rectangular legs make it an excellent choice for most conveyor systems
- Fork lift: 4-ways
- Pallet truck: 4-ways
- ISPM 15 exempt



Model No.	Dimensions			Capacity lbs.		Wt. lbs.
	L" x W" x H"	Static	Dynamic			
CB520	48 x 40 x 5	30000	3000	29		
CB524	48 x 48 x 5 3/4	30000	4000	45.5		

RACKSTAR PALLETS

- Ideal for use in food industry and in situations where higher capacity racking capabilities are important
- Double-deck, 1-piece construction with an open grid and large corner for easy cleaning
- Standard high-density polyethylene or USDA/ FDA approved HDPE
- In an edge-supported rack, pallet can hold up to a 2500 lbs. evenly distributed load
- Dynamic load capacity of 5000 lbs.
- Static load capacity: 30000 lbs.
- 4-way fork lift or pallet truck entry
- Colour: Standard-Black, USDA/FDA-Blue
- ISPM 15 exempt

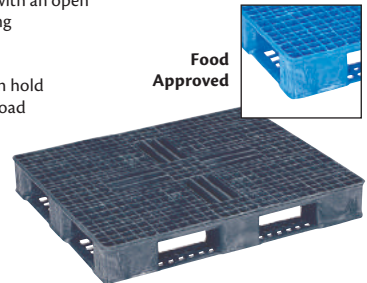

Model No.	Description	Dimensions"			Wt. lbs.
		L" x W" x H"			
CB536	Standard	48 x 40 x 6 5/8	49.5		
CB537	USDA/FDA Food Approved	48 x 40 x 6 5/8	49.5		

Note: Test for pallet deflection on loads over 2500 lbs. when used with unsupported (edge-supported) pallet rack.

MEDIUM-DUTY FOOD GRADE PALLETS

- Typically used in the food industry
- 1-piece construction with an open grid for easy cleaning
- Made of FDA compliant HDPE virgin material for direct food contact
- Edge-supported pallet on a rack can hold up to a 2200-lb evenly distributed load
- 4-way fork lift or pallet truck entry
- ISPM 15 exempt



Model No.	Dimensions			Capacity lbs.		Wt. lbs.
	L" x W" x H"	Static	Dynamic			
MN490	48 x 40 x 6 5/8	25000	5000	35		

NESTABLE LIGHTWEIGHT PALLETS WITH LIP

- 5/8" raised edge surrounding the deck prevents loads from sliding off
- Single faced, one-piece high-density polyethylene construction
- Cleans easily with efficient drainage design
- Nestable
- 4-way fork lift and 2-way pallet truck entry
- ISPM 15 exempt



ORBIS

Model No.	Dimensions			Capacity lbs.		Wt. lbs.
	L" x W" x H"	Static	Dynamic			
CB521	48 x 40 x 5 1/2	10 000	2500	21		

Also available in USDA/FDA approved material for non-direct food contact.

EXTRA-LONG STACKABLE PALLETS

- Pallet is fully reversible for double stacking of loads
- Manufactured in HDPE structural foam
- Designed for handling and shipping heavy product loads
- Ideal for stack loading, conveying systems, distribution and static storage
- 4-way entry for fork trucks
- ISPM 15 exempt



ORBIS

Model No.	Dimensions			Capacity lbs.		Wt. lbs.
	L" x W" x H"	Static	Dynamic			
MN170	72 x 48 x 5.8	30 000	4000	110		

PLASTIC PALLETS

Sturdy, lightweight pallets with rigid centre supports offer versatile, damage-free storage and movement for a wide range of materials. Suitable for the handling of all materials in paper, plastic or burlap bags; as well as tires, construction materials and items under assembly.

- Injection-molded plastic is easy to clean and resistant to both chemicals and weather
- Nestable (each adds only 5/8" to the height of a stack)
- 1 1/2" deep stringers can also be handled by a standard forklift
- ISPM 15 exempt

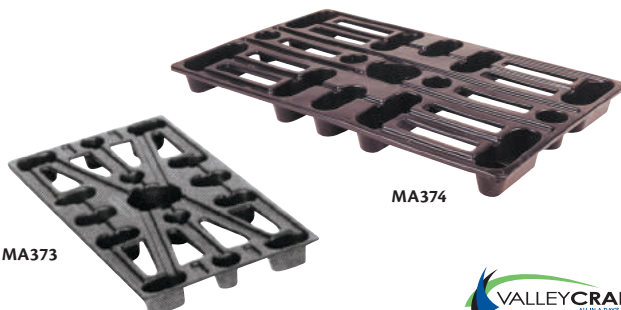

VALLEYCRAFT
ALL IN ONE WORK

Model No.	Deck Size L" x W"	Stringer Height"	Construction	Capacity lbs.	Wt. lbs.
MA373	24 x 12	1 1/2	Black Plastic	800	1
MA374	24 x 15	1 1/2	Black Plastic	800	1 1/4

SMOOTH-DECK NESTABLE PALLETS

- Manufactured in HDPE Structural Foam
- Empty pallets nest for a cost-efficient return trip or warehouse storage
- Lightweight and easy to manually handle, with no nails, splinters or broken boards to risk employee injury
- 4-way entry using both Fork Truck or Hand Trucks
- An economic and environmental alternative to wood pallets or skids
- Exempt from ISPM 15

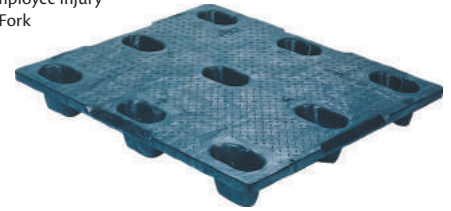

ORBIS

Model No.	Dimensions			Capacity lbs.		Wt. lbs.
	L" x W" x H"	Static	Dynamic			
MN171	48 x 40 x 6	30 000	4000	37		

DRUM PALLETS

The 48" x 48" one-piece drum pallet features four molded-in rings to secure the drums during transportation, underside rings for secure double stacking and complete flow through design.

- 100% recycled plastic
- Pallets fit side by side in regular trailers
- Standard colour: Black
- Fork truck entry: 4-ways
- Hand truck entry: 4-ways
- ISPM 15 exempt



ORBIS

Model No.	Dimensions			Capacity lbs.		Wt. lbs.
	L" x W" x H"	Static	Dynamic			
CC153	48.8 x 48.8 x 5.5	30 000	4000	57		

RETAIL DISPLAY PALLETS

- Modular
- This pallet offers marketers an attractive display solution with efficient material handling
- Easily creates in-aisle or end-of-aisle displays
- The flat, smooth surface allows for easy set up in a warehouse or co-packing facility
- Can be moved directly to sales floor to reduce labor costs and maximize storage space
- Decreases safety liabilities and product shrink by eliminating sharp edges, splinters and nails found in wood alternatives
- Pallet Entry: 4-Way
- ISPM 15 exempt

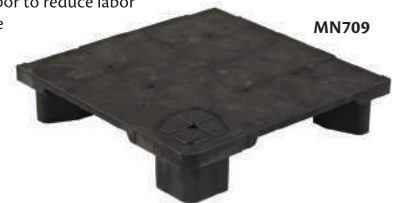

ORBIS

MN709

Model No.	Dimensions			Capacity lbs.		Wt. lbs.
	L" x W" x H"	Static	Dynamic			
MN709	24 x 24 x 5.5	8000	1000	9		
MN713	48 x 24 x 5.5	15 000	2000	19		
MN710	48 x 48 x 5.5	20 000	4000	38		
MN712	48 x 40 x 5.5	30 000	4000	39.3		

SMALL-FORMAT PALLET

- Truckload Quantity (53' trailer): 1,845
- 30" pallet width provides access through narrow doorways and is easy to manoeuvre
- Designed to optimize the supply chain of small retailers
- Generous clearance for forklifts to de-nest a full stack of pallets
- Added efficiency with molded-in stretch wrap notches in each pallet corner
- Recyclable
- Pallet Entry: 4-Way
- Colour: Black
- Material: Plastic



ORBIS

Model No.	Dimensions			Capacity lbs.	
	L" x W" x H"	Static	Dynamic		
CF933	42 x 30 x 6	10 000	2000		

WIRE MESH PARTITIONS & ENCLOSURES

Rugged Kleton wire mesh partitions and enclosures provide maximum security at a minimal cost. It is ideal for the storage of tools, valuable inventory, hazardous materials and any area of your plant where restricted access is required.

Wire mesh panels permit full visibility and allow for unrestricted circulation of air, heat and light, providing an ideal storage facility.

- 2" x 2" x 10-gauge wire mesh
- 10-gauge frame (stiffeners included on all applicable sizes)
- Pre-drilled modular components allow for quick and easy installation
- Durable Kleton blue or safety yellow finish (Other colours available)



WIRE MESH PARTITION COMPONENTS

Everything necessary to create your own custom enclosure. Fast and easy assembly, multiple sizes available. Please follow these guidelines for determining the components required.

1. UNIVERSAL POSTS

A post must be placed at each end of every panel (or of every stack of panels). Be sure to calculate an extra 2" of overall wall length for each post added. When a post meets an existing wall, add one **KD115** wall bracket for proper support (fasteners are included with **KD115** to mount to post, not to wall).

Universal Posts

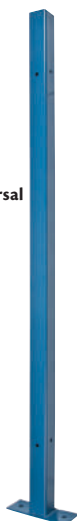

Blue Model No.	Yellow Model No.	Height	Wt. lbs.
KD053	KH860	8' 3"	22
KD046	KH922	10' 3"	27
KD050	KH923	12' 3"	32

2. PANELS

Whenever possible, stacking panels horizontally (one above the other) is more economical than placing them vertically (next to each other) - this is because fewer posts are required for wall support when panels are stacked.

Examples:

- For an 8' high partition, stack two **KD037** (8' x 4') panels horizontally
- For a 10' high partition, stack two **KD037** (8' x 4') and one **KD033** (8' x 2') panel horizontally
- For a 12' high partition, stack three **KD037** (8' x 4') panels horizontally

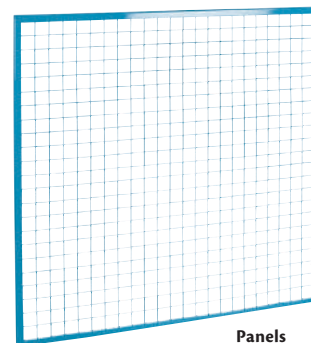

Panels



Safety Yellow

Blue Model No.	Yellow Model No.	Frame Dimensions			Wt. lbs.
		W'	x	H'	
KD121	KH926	4	x	1	10
KD120	KH927	8	x	1	21
KD030	KH928	2	x	2	10
KD031	KH929	3	x	2	11
KD032	KH914	4	x	2	12
KD033	KH915	8	x	2	31
KD034	KH916	8	x	3	40
KD035	KH930	3	x	4	20
KD036	KD130	4	x	4	23
KD037	KD131	8	x	4	45

3. ADJUSTABLE FILLER PANELS

Adjustable filler panels fill in blank spots on the ends of wire mesh partitions to plug up potential security risks. Filler panels come in two sizes: 1' x 4' and 1' x 8' that slide over the ends of existing wire mesh sections. Bolt holes on the filler panels are separated per every inch and allow the filler panel to fill in a space between 6" and 10" wide. The holes line up with holes on the existing panel which are drilled in at the top and bottom to securely fasten the filler panel in two places.

Adjustable Filler Panels



Blue Model No.	Yellow Model No.	Dimensions			Wt. lbs.
		W'	x	H'	
KD119	KH924	4	x	1	5
KD118	KH925	8	x	1	10

WIRE MESH PARTITIONS & ENCLOSURES

WIRE MESH PARTITION COMPONENTS (CONTINUED)

Everything necessary to create your own custom enclosure. Fast and easy assembly, multiple sizes available. Please follow these guidelines for determining the components required.



Customize it to your specifications. See page B87 for details.

4. SWING DOORS

HEAVY-DUTY

- Frame constructed with 1 1/4" x 1 1/4" square tube and 1" x 1" angle iron
- All are 7' in height and include a 1' transom for a total of 8' height
- May swing outwards to the left or to the right (except the **KD112** and **KH937** heavy swing door with wicket which swings open to the left only)
- Fasteners are included

STANDARD-DUTY

- Frame constructed with 1 1/4" x 1 1/4" angle iron frame
- All are 7' in height and include a 1' transom for a total of 8' height
- May swing outwards to the left or to the right
- Fasteners are included

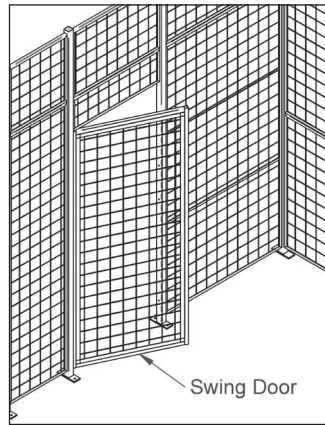

Blue Model No.	Yellow Model No.	Description	Dimensions W' x H'	Wt. lbs.
KD110	KH933	Heavy-Duty Swing Door	3 x 7	65
KH853	KH934	Standard-Duty Swing Door	3 x 7	54
KD111	KH935	Heavy-Duty Swing Door	4 x 7	74
KH854	KH936	Standard-Duty Swing Door	4 x 7	62
KD112	KH937	Heavy-Duty Swing Door w/Wicket	4 x 7	85

5. SLIDING DOORS

HEAVY-DUTY

- Frame constructed with 1 1/4" x 1 1/4" square tube and 1" x 1" angle iron
- All are 7' 7" in height and require one or more 8' lengths of 5" tall sliding door track, for a total of 8' height
- All sliding doors may slide open to the left or to the right
- To properly mount a sliding door, a post must be located on the side onto which the door slides, at the same distance away from the opening as the doors width

STANDARD-DUTY

- Frame constructed with 1 1/2" x 1 1/2" angle iron frame
- All are 7' 7" in height and require one or more 8' lengths of 5" tall sliding door track, for a total of 8' height
- All sliding doors may slide open to the left or to the right
- To properly mount a sliding door, a post must be located on the side onto which the door slides, at the same distance away from the opening as the doors width

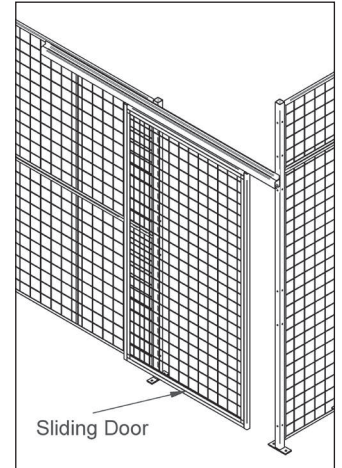

Blue Model No.	Yellow Model No.	Description	Dimensions W' x H'	Wt. lbs.
KH852	KH938	Standard-Duty Sliding Door	4 x 8	71
KD106	KH939	Heavy-Duty Sliding Door	4 x 8	85
KD108	KH940	Heavy-Duty Sliding Door	8 x 8	122
KD107	KH941	Heavy-Duty Sliding Door	8 x 10	148

6. HARDWARE REQUIRED

For Each Stacked Panel Add:

- 4 x **MMH254**, 4 x **MMB721** for each 8' stacked panel
- 2 x **MMH254**, 2 x **MMB721** for each stacked panel under 8' long

For Each Post Add:

- 8 x **MMH262**, 8 x **MMB721**, 2 x **KD001** for each **KD053** and **KH860**
- 12 x **MMH262**, 12 x **MMB721**, 2 x **KD001** for each **KD046** and **KH922**
- 12 x **MMH262**, 12 x **MMB721**, 2 x **KD001** for each **KD050** and **KH923**

For Each Sliding Door Add:

- 1 x **KD028**, 1 x **KD029** door track for each **KD106** and **KH852** 4' wide sliding door
- 1 x **KD028**, 2 x **KD029** door track for each **KD108** and **KD107** 8' wide sliding door

Blue Model No.	Yellow Model No.	Description	Wt. lbs.
KD029	KH942	8' Door Track	16
KD028	KH943	Sliding Door Hardware Kit	6
KD115	KH944	Wall Bracket Kit	0.1
MMH254*	-	5/16" x 1" Carriage Bolt	0.01
MMH262*	-	5/16" x 3" Carriage Bolt	0.01
MMB721	-	Nut 5/16" Hex	0.01
KD001	-	3/8" Anchor Bolt	0.01

* 1 x **MMB721** is required for each **MMH254** and **MMH262**.

STRIP CURTAIN DOORS

Everything you need in one package to install your own strip curtain door and save money!

ORDERING INFORMATION

Every strip curtain door comes complete with PVC strips and universal hardware for mounting strip curtain. Simple-to-follow installation instructions are included in every package.

- Determine inside width and height of door opening.
NOTE: If mounting on door above lintel, measure from floor to mounting height.
- Select type of PVC material required: STANDARD or LOW TEMP.
Standard recommended for temperatures from -23°C to 66°C.
Low Temp. recommended for interior use only for temperatures from -40°C to 66°C.
- Select from the standard sizes listed in the chart below.
NOTE: If required size is not available, order the next largest size.
Installation instructions describe how simple trimming can custom fit almost any door opening.
- Special size doors and hanging applications are available upon request.
- For overhead doors, please call one of our sales representatives for assistance.



INTERIOR DOORS



- Save energy costs**
- The optimal solution to open door heat/cooling loss
- Reduce noise pollution**
- Provides the ideal acoustical barrier around noisy equipment

Every strip curtain door comes complete with PVC strips and universal hardware for door or wall mounting. Simple-to-follow installation instructions included in every package.

EASY TO ORDER

It is easy to order the strip curtain that fits your door exactly because seven standard sizes can be made to fit 95% of most door openings. Special sizes are available.

CONVEYORS

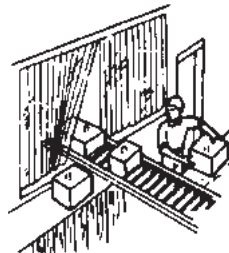

- Provide extra safe passage**
- People can see and be seen so there is less chance of accidents
- Control smoke, dust and sprays**
- Strip curtains can control in-plant contaminants to improve employee environment

STANDARD DOOR SIZES

Model No. Standard	Model No. Low Temp.	Strip Dimensions	Door Opening			Wt. lbs.
			W'	x	H'	
KF022	KF004	8" x 0.080"	4	x	7	25
KF023	KF005		5	x	8	35
KF024	KF006		6	x	8	40
KF026	KF008	12" x 0.120"	8	x	8	80
KF025	KF007		8	x	10	100
KF020	KF002		10	x	10	125
KF021	KF003		12	x	12	175

NOTE: Doors with 8" strips have 2" standard overlap.
Doors with 12" strips have 4" standard overlap.

REPLACEMENT STRIPS - 5 PER CARTON

Model No. Standard	Model No. Low Temp.	Strip Dimensions	Wt. lbs.
KF032	KF013	8" x 0.080 x 8'	15
KF029	KF011	12" x 0.120 x 12'	45

BULK ROLLS

Model No. Standard	Model No. Low Temp.	Strip Dimensions	Colour	Roll'	Wt. lbs.
KI226	KI224	8" x 0.080"	Clear	300	99
KI225	KI223	12" x 0.120"	Clear	200	150
KF031	-	16" x 0.160"	Clear	100	140
ML959*	-	8" x 0.080"	Dark Amber	300	99

* For welding applications

DOCKS



- Low maintenance**
- Clear flexible vinyl resists stretching and stands up to abrasion
 - All aluminum hardware is used for maximum durability
 - May be quickly and easily cleaned with detergents or cleansing agents that are free from abrasives
 - Deep stains and ingrained dirt can be removed by carefully applying ethanol



CUSTOMIZE IT TO YOUR SPECIFICATIONS. SEE PAGE B87 FOR DETAILS

FIXED MOUNTING SYSTEM

Model No.	Description
KF001	Complete 4' aluminum angle mount

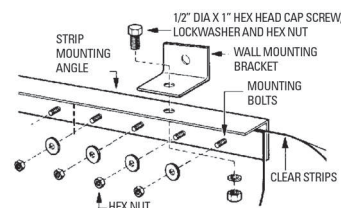

CURTAIN PARTITIONS

- Curtain partitions screen, isolate, enclose and protect any area of any size
- Commonly used in welding and paint shops, but can be used anywhere
- Brackets made of 16-gauge steel and designed for wall or ceiling mount but can be self supported by floor stands
- Large selection of drape material can be utilized with any curtain

DESIGN YOUR OWN CURTAIN

Curtains - Take exact length of area of enclosure and add 10% fullness for proper draping. Then multiply length and height to obtain square footage. Curtains hemmed on top and two sides 2" pocket on bottom side. Brass grommets spaced every 12". Refer to model number for square footage cost of fabric required.

Track - Straight and curved. Straight track available in 5' and 10' lengths. Curved corners are 3' long with 2' radius welded splicer on each end included. When using a curved track, length is increased by 2', e.g. 8' straight track with a curve at each end overall = 12'.

Carriers - Since curtains are made to any length be sure to add one additional carrier to actual length of curtain ordered. For example every 10' of curtain is fabricated with 11 grommets on top side. Therefore 11 carriers are required. A double carrier should be used at the beginning of each curtain. Steel roller carriers are permanently lubricated enclosed bearings.

Clamps - Available for flush ceiling/beam mounting and floor mounting. Clamps can also be used as track splicers. All fasten with supplied Allen bolts. Order sufficient clamps to support track every 5'.

Standards - When free standing uprights are required, be sure to specify clamps for fastening track on posts **KB032** (posts are required every 8'). Other custom heights on application.

Note: All posts should be lagged or welded to floor as required.

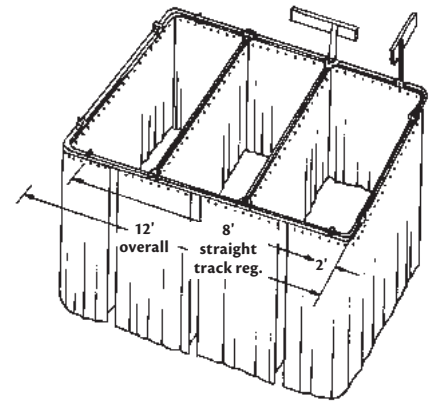

Model No.	Description
TRACKS	
KB017	5', 16 ga. Track
KB016	10', 16 ga. Track
KB029	Track Splicer
KB012	End Stop
ROLLERS	
KB013	Single Nylon Roller 25 lbs., Cap. 1" Hook
KB018	Single Steel Roller 75 lbs., Cap. 1" Hook
KB019	Double Steel Roller 125 lbs., Cap. 1" Hook
KB014	Overlap By-Pass Roller 12" Long x 2 3/4" High
WALL MOUNTS	
KB020	Wall Connector Bracket, Down
KB021	Wall Connector Bracket, Up
KB011	End Connector Fastener, Up
KB010	End Connector Fastener, Down

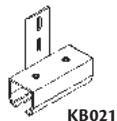
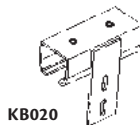
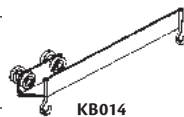
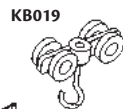
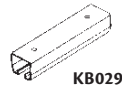

Model No.	Description
CURTAIN	
KB040	10 oz/sq.yd., Before Treatment Cotton Duck, Flame Resistant Army Green
KB004	14 mil Yellow PVC, Flame Resistant
KB003	14 mil Green PVC, Flame Resistant
KB038	20 mil Clear PVC, Flame Resistant

Other colours are available

Model No.	Description
FLOOR MOUNTS	
KB009	3' 90° Curve Track
KB025	Track Splicer
KB027	90° Corner Connector
KB024	3-Way T-Connector
KB032	8' Square Post
KB005	12" x 12" Base
BEAM MOUNTS/SUSPENSION	
KB008	3' 90° Curve Track
KB031	Ceiling Clamp
KB028	90° Corner Connector
KB023	3-Way T-Connector
CEILING MOUNTS	
KB007	3' 90° Curve Track, Three Flush Connectors
KB030	Track Splicer
KB026	90° Corner Connector
KB022	3-Way T-Connector

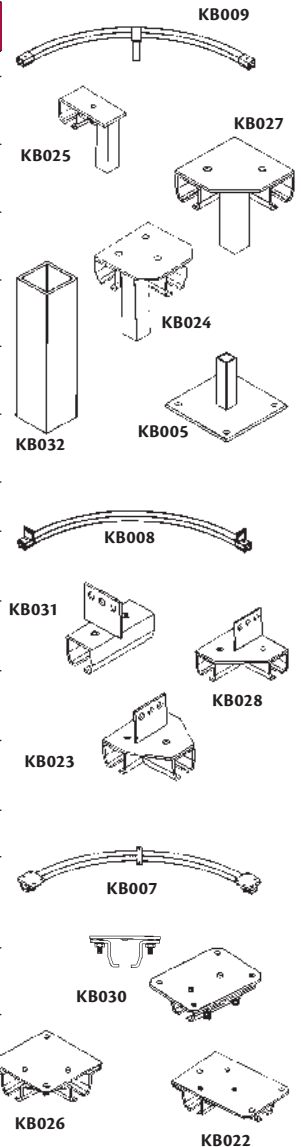

















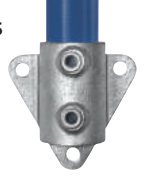

STRUCTURAL PIPE FITTINGS

There are many variations of fittings to suit a wide range of applications, providing the versatility to achieve any structural configuration. Pipe fittings are galvanized malleable iron castings designed to suit eight sizes of tube. A standard hex key and tube cutters are the only tools required to create strong, rigid structures. Recessed set screws, tightened by the hex key, firmly lock the tube into the fitting. The setscrew is manufactured in case hardened steel and is coated to protect against corrosion.

- Simple method of constructing tubular structures
- Cost effective alternative to welding
- Galvanized to resist corrosion



Pipe size O.D." 1.05 1.315 1.66 1.90 2.375	SHORT TEES RK597 RK598 RK599 RK600 RK601 	LONG TEES RK602 RK603 RK604 RK605 RK606 	SIDE OUTLET TEES RK607 RK608 RK609 RK610 RK611 	TWO SOCKET CROSSES RK612 RK613 RK614 RK615 RK616 
1.05 1.315 1.66 1.90 2.375	90° ELBOWS RK617 RK618 RK619 RK620 RK621 	3 WAY 90° ELBOWS RK628 RK629 RK630 RK631 N/A 	BASE FLANGES RK638 RK639 RK640 RK641 RK642 	RAILING BASE FLANGES RK643 RK644 RK645 RK646 RK647 
1.05 1.315 1.66 1.90 2.375	PLASTIC END PLUGS RA179 RA180 RA181 RA182 RA183 	CLAMP-ON TEES RK651 RK652 RK653 RK654 N/A 	HANDRAIL BRACKETS RK663 RK664 RK665 RK666 N/A 	SIDE PALM FIXINGS N/A RK671 RK672 RK673 N/A 
1.05 1.315 1.66 1.90 2.375	SHORT SWIVEL TEES RK677 RK678 RK679 RK680 N/A (sold in pairs only) 	SLEEVE JOINTS RK681 RK682 RK683 RK684 RK685 	INTERNAL JOINTS N/A RK686 RK687 RK688 N/A 	90° CROSSOVERS RK697 RK698 RK699 RK700 RK701 
1.05 1.315 1.66 1.90 2.375	OUTLET TEES RK752 RK753 RK754 RK755 RK756 	GROUND SOCKETS N/A RK648 RK649 RK650 N/A 	GATE EYES RK655 RK656 RK657 RK658 N/A 	GATE HINGES RK659 RK660 RK661 RK662 N/A 

PIPES

Build an unlimited array of strong rigid structures combining standard black iron (unthreaded) pipe or galvanized (threaded-on one side) pipe (schedule 40), with any combination of corresponding sized fittings. Pipe sizes are available from 3/4" to 2" (inside diameter). Standard pipe length is 21 ft., with cut lengths available upon request. A cutting charge will be added per cut length of piping.

Black Iron Model No.	Galvanized Iron Model No.	Pipe O.D."	Pipe I.D."
RA109	RA110	1.05	3/4
RA111	RA112	1.315	1
RA113	RA114	1.66	1 1/4
RA115	RA116	1.9	1 1/2
RA117	RA118	2.375	2

TOOLS



Model No.	Description
TX413	T-Handle hex key for 1.05", 1.315" and 1.66" pipes
TX414	T-Handle hex key for 1.90" and 2.375" pipes

SHELVING & RACKING

WIDE SPAN RECORD STORAGE SHELVING

- Efficiently organize and store all records in a single information retrieval center
- Record management is facilitated with easy to identify printed storage boxes
- 12-gauge steel posts and beams and warp free particle board decks provides maximum strength
- Easy to install with snap together shelf beams, no nuts and bolts
- Storage boxes constructed of white corrugated fibreboard, with handles, making it a durable and easily maneuverable box, a perfect choice for economical storage
- Order complete units, including shelving, deck and boxes, or shelving with deck only
- Grey

RN004

RN009



METALWARE
STEEL SHELVING
corporation

Shelving & Deck Only Model No.	Complete Unit w/Boxes Model No.	No. of Shelves	Dimensions L" x D" x H"	No. of Boxes
RL997	RN006	3	72 x 18 x 60	30
RL998	RN007	3	72 x 32 x 60	60
RL999	RN008	4	72 x 18 x 84	40
RN001	RN009	4	72 x 32 x 84	80
RN002	RN010	3	42 x 18 x 60	18
RN003	RN011	3	42 x 32 x 60	36
RN004	RN012	4	42 x 18 x 84	24
RN005	RN013	4	42 x 32 x 84	48

ULTRARACK HEAVY-DUTY BOLTLESS SHELVING

- Modular design; use as storage shelving, a work centre or assemble as a workbench
- Heavy-duty 16-gauge steel construction provides maximum weight carrying capacity
- Each shelf supports 600 - 1800 lbs. based on evenly distributed loads
- Double riveted beams lock into heavy-duty corner post to form a structurally secure unit
- Includes five particleboard shelves that adjust easily on 1 1/2" centres
- Convenient access from all four sides
- Tough baked enamel finish



Model No.	Dimensions			Cap./Shelf lbs.
	W"	D"	H"	
RL894	36	18	72	1200
RL895	36	24	72	1800
RL896	48	18	72	1000
RL897	48	24	72	1400

HEAVY-DUTY BULK STORAGE RACKS

- These racks bridge the gap between pallet racking and conventional industrial racking
- Engineered for hand loading of intermediate weight bulky items
- Constructed of all welded 14-gauge steel upright frames punched on 1 1/2" centres
- 14-gauge Z-step beam design provides maximum weight capacity
- Comes with 5/8" thick particle board decking (steel decking also available)
- Additional shelves include two beams and a deck
- Other dimensions also available
- Assembly required



Innovative Z-Beam Design

Starter Model No.	Wt. lbs.	Add-on Model No.	Wt. lbs.	Rack Height'	Rack Width"	Cap. lbs./Shelf
STANDARD 3 SHELF UNITS - 24" DEEP UNIT						
RK028	181	RK046	158	6	60	4000
RK029	205	RK047	182		72	3500
RK030	253	RK048	230		96	2800
RK031	199	RK049	167	8	60	4000
RK032	223	RK050	191		72	3500
RK033	271	RK051	239		96	2800
STANDARD 3 SHELF UNITS - 36" DEEP UNIT						
RK040	221	RK052	196	6	60	4000
RK041	254	RK053	229		72	3500
RK042	317	RK054	292		96	2800
RK043	243	RK055	207	8	60	4000
RK044	276	RK056	240		72	3500
RK045	339	RK057	303		96	2800

ADDITIONAL SHELVES

24" Deep unit	Wt. lbs.	36" Deep unit	Wt. lbs.	Rack Width"
RK058	45	RK061	57	60
RK059	53	RK062	68	72
RK060	69	RK063	89	96

EXTRA HEAVY-DUTY SHELVING

DESIGNED TO HOLD THE HEAVIEST LOADS

- Clear access on all four sides
- Excellent for storage of dies, fixtures, jigs or any heavy material
- Formed angle 2" x 2" uprights are constructed of 13-gauge steel, punched on 1" centres for quick and easy shelf adjustment
- Powder coat finish
- Shelf capacities are based on loads that are evenly distributed
- Extra shelves and 96" high units are available
- Each unit includes five shelves
- Assembly required

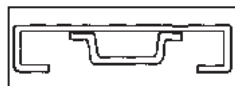

Shelves:

14-gauge, 2" deep channels on all four sides.
An extra channel welded to the bottom of shelf to prevent flexing under heavy loads.

Model No.	Dimensions			Cap lbs./Shelf	Wt. lbs.
	W"	D"	H"		
RC524	36	18	72	3000	167
RC525	48	18	72	3000	212
RC526	60	18	72	3000	252
RC527	36	24	72	3000	197
RC528	48	24	72	3000	242
RC529	60	24	72	3000	292



SHELVING

SLOTTED ANGLE SHELVING UNITS

- Cost-effective storage solution
- Shelving is easy to assemble, sturdy and long-lasting
- Boltless design allows for quick and easy adjustability
- Kit Type: Starter
- Material: Galvanized Steel
- Shelving Type: Open
- Assembly required



Model No.	No. of Shelves	Shelf Capacity lbs.	Dimensions W" x D" x H"
RN199	6	400	36 x 12 x 72
RN200	6	400	36 x 15 x 72
RN201	6	400	36 x 18 x 72
RN202	6	400	36 x 24 x 72
RN203	6	300	48 x 12 x 72
RN204	6	300	48 x 15 x 72
RN205	6	275	48 x 18 x 72
RN206	6	275	48 x 24 x 72
RN207	7	400	36 x 12 x 84
RN208	7	400	36 x 15 x 84
RN209	7	400	36 x 18 x 84
RN210	7	400	36 x 24 x 84
RN211	7	300	48 x 12 x 84
RN212	7	300	48 x 15 x 84
RN213	7	275	48 x 18 x 84
RN214	7	275	48 x 24 x 84
RN215	8	400	36 x 12 x 96
RN216	8	400	36 x 15 x 96
RN217	8	400	36 x 18 x 96
RN218	8	400	36 x 24 x 96
RN219	8	300	48 x 12 x 96
RN220	8	300	48 x 15 x 96
RN221	8	275	48 x 18 x 96
RN222	8	275	48 x 24 x 96

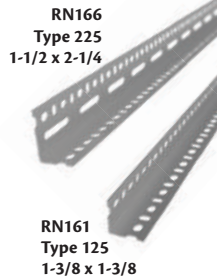

SLOTTED ANGLE POSTS

- Versatile post can be cut or bolted into workbenches, shelves, or tables
- Can also be used as top tie with Metalware Widespan and Interlock product line
- Angle Gauge: 14

Model No.	Height"	Type	Slotted Angle Dimensions"
RN161	72	125	1-3/8 x 1-3/8
RN162	84	125	1-3/8 x 1-3/8
RN163	96	125	1-3/8 x 1-3/8
RN164	120	125	1-3/8 x 1-3/8
RN165	144	125	1-3/8 x 1-3/8
RN166	72	225	1-1/2 x 2-1/4
RN167	84	225	1-1/2 x 2-1/4
RN168	96	225	1-1/2 x 2-1/4
RN169	120	225	1-1/2 x 2-1/4
RN170	144	225	1-1/2 x 2-1/4

SLOTTED ANGLE SIDE BRACES

Model No.	Length"
RN171	18
RN172	21
RN173	33
RN174	39

SLOTTED ANGLE BACK BRACES

Model No.	Length"
RN175	51

SLOTTED ANGLE END PANELS

Model No.	Depth"
RN178	12
RN179	12
RN180	12
RN181	15
RN182	15
RN183	15

Model No.	Depth"
RN184	18
RN185	18
RN186	18
RN187	24
RN188	24
RN189	24

SLOTTED ANGLE SHELVES

Model No.	Depth"	Shelf Capacity lbs.
RN152	12	400
RN153	15	400
RN154	18	400
RN155	24	400
RN156	32	300
RN157	12	300
RN158	15	300
RN159	18	275
RN160	24	275

SLOTTED ANGLE BACK PANELS

Model No.	Dimensions W" x H"
RN190	36 x 72
RN191	48 x 72
RN192	36 x 84
RN193	48 x 84
RN194	36 x 96
RN195	48 x 96

SLOTTED ANGLE KICK PLATES

Model No.	Dimensions W" x H"
RN196	42" x 3"
RN197	42" x 3"
RN198	48" x 3"

Steel slotted angle allows you to design and build anything to your own specifications:

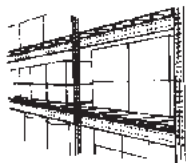

Metal Decking



Tubing Storage

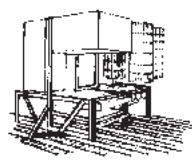

Overhead Storage

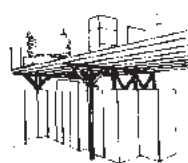

Overhead Storage

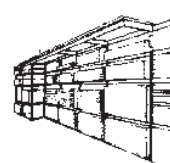

Wide Storage

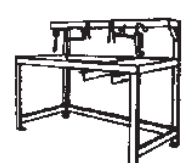

Special Work Benches

SLOTTED ANGLE ACCESSORIES

CORNER GUSSET PLATES

- Add strength and rigidity to your slotted angle assembly
- 3" W x 3" L

PLASTIC FEET

- 1 3/8" x 1 3/8" angle posts

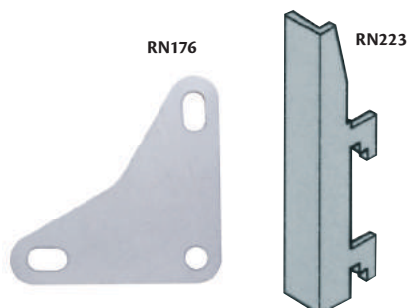

ACCESSORIES

Model No.	Description	Wt. lbs.
RN176	Corner Gusset Plate 3"	0.70
RN177	Nut and Bolt	0.05
RN223	Boltless Shelf Clip	0.60
RL344*	Plastic Foot for Single Post	0.02

*For 1 3/8" X 1 3/8" posts

LABEL HOLDERS

- Clearly identify your shelf/bin contents with the efficient and time-saving Aigner holders
- Versatile, highly protective, easy to read, and even custom designed with a special matte finish, making bar code applications easy
- Ideal for all types of racking, shelving and bin/drawer storage systems
- Labels provided

HOL-DEX™

- Can be custom cut to your specific size specifications
- Package of 12



SUPERSCAN™

- Available in 4 extra large sizes for pallet-racking installation
- Clear plastic matte finish assures precise bar code reading everytime
- Inserts are laser ink jet printer compatible for easy labeling



SUPERSCAN™ (CLEAR ONLY)

Model No.	Dimensions W" x L"	Qty /Box	Model No.	Dimensions W" x L"	Qty /Box
SELF-ADHESIVE			MAGNETIC		
OG356	2 x 3 1/2	50	OG357	2 x 3 1/2	50
RG670	3 x 5	50	RG672	3 x 5	50
RG671	4 x 6	50	RG673	4 x 6	50
RG681	5 x 7	25	RG683	5 x 7	25

WIRE-RAC™

- Snap-on holders easily and quickly identify stored contents
- Clear, flexible plastic sleeves fit new or existing wire shelving with 1 1/4" facing; paper inserts included

Model No.	Dimensions W" x L"	Qty /Box
RH683	1 5/16 x 3	25
RH684	1 5/16 x 6	25
RH685	1 5/16 x 12	12
RH686	1 5/16 x 24	6



SLIP 'N STIK™ AISLE SIGNS

- Create your own customized warehouse signs
- Built-in flexible hinge prevents breakage
- Includes:** 10 sign holders (11" x 8 1/2"), 12 yellow laser/ink jet sheets and instructions

Model No. OE798 Snap-On

- Snaps into pallet rack assembly holes, can snap out to relocate

Model No. OJ943 Self-Adhesive

- Adheres to flat surfaces, for more permanent applications



WRITE-ON MAGNETIC TAGS

- A fast, simple and inexpensive means of labeling high-volume applications, primary uses in warehouses and other storage areas
- Newly formulated write-on/wet erase tags come with a strong magnetic backing
- Special wet-erase feature will keep tags clear and clean for extended periods
- Mark with a standard wet erase marker, erase with a damp cloth and remark

50' ROLLS

Model No.	Width"
RH698	1
RH699	2
RH700	3

TAGS, 25/BOX

Model No.	Dimensions W" x L"
RH696	3 x 6
RH697	3 x 8
RH693	2 x 6

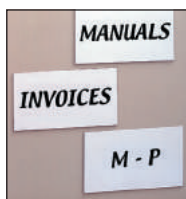

HOL-DEX®

Model No.	Dimensions W" x L"
SELF-ADHESIVE	
OA340	1/2 x 6
OA339	3/4 x 6
OA341	1 x 6
OA338	2 x 6
MAGNETIC	
RG650	1/2 x 6
OA389	3/4 x 6
OA336	1 x 6
HOOK & LOOP	
RG660	1 x 6
RG665	2 x 6

MAGNETIC TAPE FOR LABELS

- Peel and stick computer printed or hand written labels to non magnetic (matte) side
- Scissor cut to desired length
- Magnetic (shiny) side adheres to metal surface
- Can change label or relocate as required



Model No.	Dimensions W" x L"
OJ940	1 x 50
OJ941	2 x 50
OJ942	3 x 50

Custom pre-scored sizes available

SLIP STRIP™ LABEL HOLDING SYSTEMS

- Excellent for displaying bar codes, messages, prices or other information on pallet racking and shelving
- Self-adhesive label/document holder system allows you to change labels without messy adhesive build-up
- 6 per package



Model No.	Dimensions W" x L"
OE802	1 x 3
OE803	1 1/4 x 4
OE804	2 x 4

MAGNETIC CARD HOLDERS

- Fast, simple and versatile means of labeling
- Great for metal racks, shelves, bins, drawers and more
- Insertable magnetic C-channel design allows for labels to be changed simply by re-marking the paper insert or re-positioning the magnet
- Black
- Custom cut sizes available on special order
- Inserts included

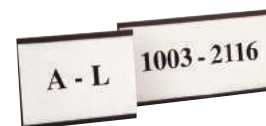

Model No.	Dimensions W" x L"	Qty /Box
OE250	1 x 3	25
OE251	1 x 4	25
OE252	1 x 6	25
OE253	1 x 8	25
OE254	2 x 3	25
OE255	2 x 4	25
OE256	2 x 6	25
OE257	2 x 8	25
OE258	3 x 4	25
OE259	3 x 6	25
OE260	3 x 8	25



PREMIUM JOB TICKET HOLDERS

- Protect work orders, production schedules, inventory cards and other important documents from excessive handling and wear
- Sewn edges are reinforced with heavy-duty vinyl and a brass eyelet is centered for hanging
- Clear 8 mil. PVC for easy visibility

Model No.	Dimensions W" x L"	Qty /Box
PC529	9 x 6	25
PC530	12 x 9	25

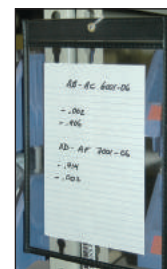

OPEN-EDGE™ LABEL HOLDERS

- The "top loading" feature is ideal for organizing any storage area
- Strong adhesive system assures the label holder will not fall off any clean dry surface
- Made from clear, durable, heavy-duty PVC that is bar code compatible
- White inserts included

Model No.	Dimensions W" x L"	Qty /Box
OG358	1/2 x 12	100
OG359	1 x 12	100
OG360	2 x 12	100
OG361	3 x 5	100



SHELVING

BOLTLESS SHELVING UNITS

- Adjustable shelving system that provides high strength, yet economical storage capacity for your needs
- This system uses an innovative shelf clip, which slips into a slotted "T" post and is immediate ready to receive a shelf
- No-Bolt design reduces up to 80% of installation time
- Colour: Grey
- Ships knocked down

METALWARE
STEEL SHELVING
corporation



RK550
"T" Post



RK565
RK472
Side and back
braces

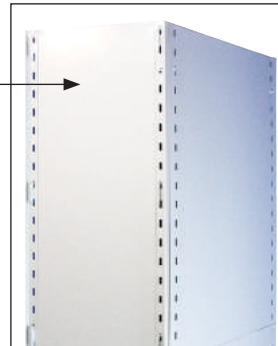

RK521
End Panels



RK483
Base Plate

"T" POSTS

- For open style shelving includes slots every 1" for shelf or brace installation
- 1 1/2" x 2" x 1/8" double-formed steel in a "T" style with a smooth unperforated face
- Capacity: 11000 lbs.

Model No.	Height	Wt. lbs.
RK549	3'4"	4
RK550	6'4"	8
RK551	7'4"	9
RK548	8'4"	10
RK544	9'4"	11



RK552
Shelves



RK470
Back panel

SHELVES

- Shelves are easily installed using four clips
- Constructed from 18-gauge steel
- 4 clips included with each shelf

Model No.	Dimensions W" x D"	Capacity lbs.	Wt. lbs.
RK552	36 x 12	630	8
RK553	42 x 12	480	9
RK554	48 x 12	315	10.5
RK555	36 x 15	630	9.75
RK556	42 x 15	480	11.5
RK557	48 x 15	315	12.5
RK558	36 x 18	630	11.5
RK559	42 x 18	480	13
RK560	48 x 18	315	15
RK561	36 x 24	630	14.75
RK562	42 x 24	480	16.5
RK563	48 x 24	315	19
RK564	36 x 30	560	18

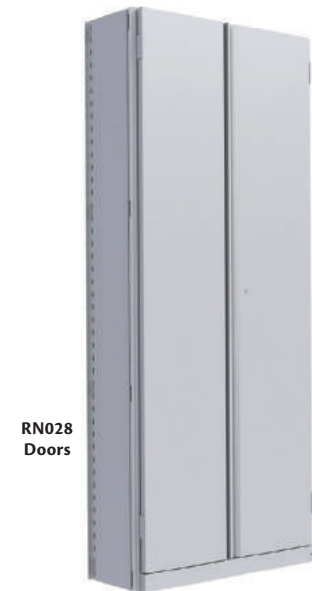

RK028
Doors

DOORS

- Lockable swinging doors installs easily on closed style shelving
- Includes **RN032** base plate

Model No.	Dimensions W x H	Wt. lbs.
RN028	36" x 6'4"	43
RN029	36" x 7'4"	50
RN032*	Replacement Base Plate	2

*Only for units with doors

BASE PLATES

- Install at floor level to close openings

Model No.	Dimensions W" x H"	Wt. lbs.
RK483	36 x 3	2
RK484	42 x 3	2.25
RK485	48 x 3	2.5

END PANELS

- For closed style shelving
- Each panel incorporates two slotted post

Model No.	Dimensions D x H	Wt. lbs.
RK521	12" x 3'4"	10.5
RK522	12" x 6'4"	20.75
RK523	12" x 7'4"	23.5
RK520	12" x 8'4"	26.25
RK525	15" x 3'4"	11.5
RK526	15" x 6'4"	22.5
RK527	15" x 7'4"	25.5
RK524	15" x 8'4"	28.5
RK537	18" x 6'4"	24
RK538	18" x 7'4"	27
RK519	18" x 8'4"	30.5
RK529	24" x 3'4"	14
RK530	24" x 6'4"	27
RK531	24" x 7'4"	31
RK528	24" x 8'4"	34.5
RK532	30" x 8'4"	38.75

BACK PANELS

- For closed style shelving
- Attach easily to end panels using back brackets provided

Model No.	Dimensions W x H	Wt. lbs.
RK470	36" x 6'4"	19
RK471	36" x 7'4"	22
RK460	36" x 8'4"	25
RK465	42" x 7'4"	25.5
RK462	42" x 8'4"	29
RK947	48" x 3'4"	13.5
RK468	48" x 6'4"	25.5
RK469	48" x 7'4"	29.5
RK466	48" x 8'4"	33.5

SIDE & BACK BRACES

- Provide stability to open style shelving units
- Sold in pairs

Model No.	Description	Wt. lbs.
RK472	Back Brace	4
RK565	Side Brace	2



RK503
Dividers



RK540
Label Holders



RK475
Bin Front

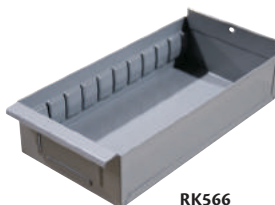

RK566
Shelf Boxes



RC453
Gusset



RL756
48" Hanger Bar



RK949
Foot Plate

DIVIDERS

- Separate shelves into bin compartments
- Constructed of 20 gauge steel

Model No.	Dimensions			Wt. lbs.
	D"	x	H"	
RK503	12	x	6	0.5
RK504	15	x	6	0.75
RK505	18	x	6	1
RK506	24	x	6	1.5
RK507	12	x	8	0.75
RK508	15	x	8	1
RK509	18	x	8	1.5
RK510	24	x	8	2
RK487	12	x	10	1
RK488	15	x	10	1.25
RK489	18	x	10	1.75
RK490	24	x	10	2.25
RK491	12	x	12	1.25
RK492	15	x	12	1.75
RK493	18	x	12	2
RK494	24	x	12	2.75
RK495	12	x	14	1.5
RK496	15	x	14	2
RK497	18	x	14	2.25
RK498	24	x	14	3.25
RK499	18	x	16	2.5
RK500	18	x	18	2.75

LABEL HOLDERS

- Install on shelf front to identify contents of shelves

Model No.	Width"	Wt. lbs.
RK540	36	0.3
RK542	48	0.3

SHELF BOXES

- Slide onto properly spaced shelving
- Extends 100% without spills
- Constructed of 20 gauge steel

Model No.	Dimensions					Wt. lbs.
	W"	x	D"	x	H"	
RK566	5 5/8	x	12	x	2 3/4	2.5
RK569	5 5/8	x	18	x	2 3/4	3.5
RK570	5 5/8	x	12	x	4 3/4	3.5
RK572	5 5/8	x	15	x	4 3/4	4
RK573	5 5/8	x	18	x	4 3/4	4.5
RK574	11	x	18	x	4 3/4	5
RK571	12	x	12	x	4 3/4	5.5

BIN FRONTS

- Used in conjunction with bin dividers

Model No.	Dimensions			Wt. lbs.
	W"	x	H"	
RK475	36	x	1	1.75
RK477	36	x	2	2
RK479	36	x	3	2.25
RK476	42	x	1	2
RK478	42	x	2	2.25
RK480	42	x	3	2.5

MISCELLANEOUS

Model No.	Description	Wt. lbs.
RK949	Foot Plate	0.3
RC453	Gusset (Pairs)	1
RL756*	48" Hanger Bar	3.5
RL757	24" Hanging Bar Bracket	0.05
RC515	Shelf Clip	0.01
RC382	Back to Back Brackets	0.01
RC505	Back Panel Clip	0.2

*Requires two brackets (RL757)

SHELVING

BOLTLESS SHELVING UNITS

- Adjustable shelving system that provides high strength, yet economical storage capacity for your needs
- This system uses an innovative shelf clip, which slips into a slotted "T" post and is immediate ready to receive a shelf
- No-Bolt design reduces up to 80% of installation time
- Colour: Grey
- Ships knocked down



36" W X 6'4" H



4 SHELVES

Starter Unit	Depth"
RK205	12
RK207	18
RK209	24

Add-On Unit	Depth"
RK204	12
RK206	18
RK208	24

36" W X 6'4" H



7 SHELVES

Starter Unit	Depth"
RK217	12
RK219	18
RK221	24

Add-On Unit	Depth"
RK216	12
RK218	18
RK220	24

36" W X 6'4" H



10 SHELVES

Starter Unit	Depth"
RK229	12
RK231	18
RK233	24

Add-On Unit	Depth"
RK228	12
RK230	18
RK232	24

36" W X 6'4" H



13 SHELVES

Starter Unit	Depth"
RK241	12
RK243	18
RK245	24

Add-On Unit	Depth"
RK240	12
RK242	18
RK244	24

36" W X 7'4" H



4 SHELVES

Starter Unit	Depth"
RK309	12
RK311	18
RK313	24

Add-On Unit	Depth"
RK308	12
RK310	18
RK312	24

36" W X 7'4" H



7 SHELVES

Starter Unit	Depth"
RK333	12
RK335	18
RK337	24

Add-On Unit	Depth"
RK332	12
RK334	18
RK336	24

36" W X 7'4" H



8 SHELVES

Starter Unit	Depth"
RK321	12
RK323	18
RK325	24

Add-On Unit	Depth"
RK320	12
RK322	18
RK324	24

36" W X 7'4" H



15 SHELVES

Starter Unit	Depth"
RK345	12
RK347	18
RK349	24

Add-On Unit	Depth"
RK344	12
RK346	18
RK348	24

48" W X 7'4" H



4 SHELVES

Starter Unit	Depth"
RK285	12
RK287	18
RK289	24

Add-On Unit	Depth"
RK284	12
RK286	18
RK288	24

48" W X 7'4" H



7 SHELVES

Starter Unit	Depth"
RK297	12
RK299	18
RK301	24

Add-On Unit	Depth"
RK296	12
RK298	18
RK300	24

36" W X 8'4" H



5 SHELVES

Starter Unit	Depth"
RK425	12
RK427	18
RK429	24

Add-On Unit	Depth"
RK424	12
RK426	18
RK428	24

36" W X 8'4" H



9 SHELVES

Starter Unit	Depth"
RK401	12
RK403	18
RK405	24

Add-On Unit	Depth"
RK400	12
RK402	18
RK404	24

BOLTLESS SHELVING UNITS

- Adjustable shelving system that provides high strength, yet economical storage capacity for your needs
- This system uses an innovative shelf clip, which slips into a slotted "T" post and is immediate ready to receive a shelf
- No-Bolt design reduces up to 80% of installation time
- Colour: Grey
- Ships knocked down



36" W X 6'4" H



4 SHELVES

Starter Unit	Depth"
RK211	12
RK213	18
RK215	24

Add-On Unit	Depth"
RK210	12
RK212	18
RK214	24

36" W X 6'4" H



7 SHELVES

Starter Unit	Depth"
RK223	12
RK225	18
RK227	24

Add-On Unit	Depth"
RK222	12
RK224	18
RK226	24

36" W X 6'4" H



10 SHELVES

Starter Unit	Depth"
RK235	12
RK237	18
RK239	24

Add-On Unit	Depth"
RK234	12
RK236	18
RK238	24

36" W X 7'4" H



4 SHELVES

Starter Unit	Depth"
RK315	12
RK317	18
RK319	24

Add-On Unit	Depth"
RK314	12
RK316	18
RK318	24

36" W X 7'4" H



7 SHELVES

Starter Unit	Depth"
RK339	12
RK341	18
RK343	24

Add-On Unit	Depth"
RK338	12
RK340	18
RK342	24

36" W X 7'4" H



8 SHELVES

Starter Unit	Depth"
RK327	12
RK329	18
RK331	24

Add-On Unit	Depth"
RK326	12
RK328	18
RK330	24

36" W X 7'4" H



15 SHELVES

Starter Unit	Depth"
RK351	12
RK353	18
RK355	24

Add-On Unit	Depth"
RK350	12
RK352	18
RK354	24

48" W X 7'4" H



4 SHELVES

Starter Unit	Depth"
RK291	12
RK293	18
RK295	24

Add-On Unit	Depth"
RK290	12
RK292	18
RK294	24

48" W X 7'4" H



7 SHELVES

Starter Unit	Depth"
RK303	12
RK305	18
RK307	24

Add-On Unit	Depth"
RK302	12
RK304	18
RK306	24

36" W X 8'4" H



5 SHELVES

Starter Unit	Depth"
RK431	12
RK433	18
RK435	24

Add-On Unit	Depth"
RK430	12
RK432	18
RK434	24

36" W X 8'4" H



9 SHELVES

Starter Unit	Depth"
RK407	12
RK409	18
RK411	24

Add-On Unit	Depth"
RK406	12
RK408	18
RK410	24

36" W X 8'4" H



13 SHELVES

Starter Unit	Depth"
RK419	12
RK421	18
RK423	24

Add-On Unit	Depth"
RK418	12
RK420	18
RK422	24

SHELVING

BOLTLESS SHELVING UNITS

- Adjustable shelving system that provides high strength, yet economical storage capacity for your needs
- This system uses an innovative shelf clip, which slips into a slotted "T" post and is immediate ready to receive a shelf
- No-Bolt design reduces up to 80% of installation time
- Colour: Grey
- Ships knocked down



36" W X 6'4" H



4 SHELVES

Starter Unit	Depth"
RK849	12
RK850	18
RK851	24

Add-On Unit	Depth"
RK852	12
RK853	18
RK854	24

36" W X 7'4" H



4 SHELVES W/ DOORS

Starter Unit	Depth"
RK893	12
RK894	18
RK895	24

Add-On Unit	Depth"
RK896	12
RK897	18
RK898	24

36" W X 6'4" H



7 SHELVES W/DOORS

Starter Unit	Depth"
RK855	12
RK856	18
RK857	24

Add-On Unit	Depth"
RK858	12
RL013	18
RL015	24

36" W X 7'4" H



7 SHELVES W/DOORS

Starter Unit	Depth"
RK899	12
RK900	18
RK989	24

Add-On Unit	Depth"
RK902	12
RK903	18
RK904	24

36" W X 7'4" H



10 COMPARTMENTS W/DOORS

Starter Unit	Depth"
RK911	12
RK912	18
RK913	24

Add-On Unit	Depth"
RK914	12
RK915	18
RK916	24

36" W X 7'4" H



21 COMPARTMENTS W/DOORS

Starter Unit	Depth"
RK921	12
RK922	18
RK923	24

Add-On Unit	Depth"
RK924	12
RK925	18
RK926	24

36" W X 6'4" H



14 COMPARTMENTS

Starter Unit	Depth"
RK259	12
RK261	18
RK263	24

Add-On Unit	Depth"
RK258	12
RK260	18
RK262	24

36" W X 6'4" H



18 COMPARTMENTS

Starter Unit	Depth"
RK265	12
RK267	18
RK269	24

Add-On Unit	Depth"
RK264	12
RK266	18
RK268	24

36" W X 6'4" H



72 COMPARTMENTS W/BIN FRONTS

Starter Unit	Depth"
RK271	12
RK273	18
RK275	24

Add-On Unit	Depth"
RK270	12
RK272	18
RK274	24

36" W X 7'4" H



14 COMPARTMENTS

Starter Unit	Depth"
RK363	12
RK365	18
RK367	24

Add-On Unit	Depth"
RK362	12
RK364	18
RK366	24

36" W X 7'4" H



21 COMPARTMENTS

Starter Unit	Depth"
RK369	12
RK371	18
RK373	24

Add-On Unit	Depth"
RK368	12
RK370	18
RK372	24

36" W X 7'4" H



84 COMPARTMENTS

Starter Unit	Depth"
RK905	12
RK906	18
RK907	24

Add-On Unit	Depth"
RK908	12
RK909	18
RK910	24

BOLTLESS SHELVING UNITS

- Adjustable shelving system that provides high strength, yet economical storage capacity for your needs
- This system uses an innovative shelf clip, which slips into a slotted "T" post and is immediate ready to receive a shelf
- No-Bolt design reduces up to 80% of installation time
- Colour: Grey
- Ships knocked down



36" W X 7'4" H



84 COMPARTMENTS
W/BIN FRONTS

Starter Unit	Depth"
RK383	12
RK385	18
RK387	24

Add-On Unit	Depth"
RK382	12
RK384	18
RK386	24

36" W X 8'4" H



24 COMPARTMENTS

Starter Unit	Depth"
RK443	12
RK445	18
RK447	24

Add-On Unit	Depth"
RK442	12
RK444	18
RK446	24

36" W X 6'4" H



36 BOXES

Starter Unit	Depth"
RK277	12
RK886	18

Add-On Unit	Depth"
RK276	12
RK983	18

36" W X 6'4" H



57 BOXES

Starter Unit	Depth"
RK986	12
RK890	18

Add-On Unit	Depth"
RK891	12
RK987	18

36" W X 6'4" H



72 BOXES

Starter Unit	Depth"
RK877	12
RK878	18

Add-On Unit	Depth"
RK879	12
RK880	18

36" W X 6'4" H



108 BOXES

Starter Unit	Depth"
RK980	12
RK982	18

Add-On Unit	Depth"
RK979	12
RK981	18

36" W X 7'4" H



42 BOXES

Starter Unit	Depth"
RK935	12
RK936	18

Add-On Unit	Depth"
RK937	12
RK938	18

36" W X 7'4" H



69 BOXES

Starter Unit	Depth"
RK939	12
RK940	18

Add-On Unit	Depth"
RK941	12
RK942	18

36" W X 7'4" H



84 BOXES

Starter Unit	Depth"
RK927	12
RK928	18

Add-On Unit	Depth"
RK929	12
RK930	18

36" W X 7'4" H



126 BOXES

Starter Unit	Dep
RK931	12
RK932	18

Add-On Unit	Depth"
RK933	12
RK934	18

36" W X 6'4" H



24 COMPARTMENTS
& 30 BOXES

Starter Unit	Depth"
RK970	12
RK868	18

Add-On Unit	Depth"
RK969	12
RK971	18

36" W X 7'4" H



27 COMPARTMENTS
& 30 BOXES

Starter Unit	Depth"
RK917	12
RK918	18

Add-On Unit	Depth"
RK919	12
RK920	18

WIRE SHELVING

CHROMATE WIRE SHELVING

- Heavy-gauge shelves with open wire design minimize dust, improve air circulation and provide greater visibility of stored items
- Post's circular grooves combined with tapered plastic split sleeves allow for assembly in minutes with no special tools
- Shelf ribs run front to back allowing items to slide on and off shelves smoothly
- Shelves can be adjusted at precise 1" intervals
- Posts are double grooved every 8" and numbered for easy adjustment
- Adjustable feet compensate for surface irregularities
- Stationary unit's total capacity should not exceed 2000-lb.
- Shipped knocked down
- NSF certified



POSTS

Model No.	Height"	Wt. lbs.
RL611	33	4
RL330	54	6.3
RL331	63	7
RL332	74	8
RL333	86	8.8

WIRE SHELVES

Model No.	Dimensions W" x D"	Cap lbs. /Shelf*	Wt. lbs.
RL606	30 x 14	800	7.5
RL607	36 x 14	800	8.25
RL608	48 x 14	800	10.5
RL609	60 x 14	600	14.25
RL610	72 x 14	600	17.5
RL035	30 x 18	800	8.5
RL036	36 x 18	800	9.75
RL037	48 x 18	800	12.5
RL038	60 x 18	600	18
RL039	72 x 18	600	20.5
RL040	36 x 24	800	13.25
RL041	48 x 24	800	16.25
RL042	60 x 24	600	21.5
RL043	72 x 24	600	27

* Evenly distributed weight

ACCESSORIES

Model No.	Description	Wt. lbs.
RL048	Caster, 5", No Brake	2.8
RL049	Caster, 5", With Brake	2.7
RL050	Divider For Shelf, 18"	1.7
RL051	Divider For Shelf, 24"	2.2
RL052	Handle 18" - Can Only Be Used With Utility Carts	3.9
RL053	Handle 24" - Can Only Be Used With Utility Carts	4.4
RL054	Split Sleeves, Black 4 Pc/Bag	0.1
RL055	S-Hook For Attaching Add-On	0.1
RL056	Leveling Feet (Die Cast And Foot Bolt)	0.2
RL057	Die Cast For Leveling Feet	0.1
RL058	Foot Bolt For Leveling Feet	0.1
RL612	Direct Wall Mount, Single Shelf Support, 14"	2
RL613	Direct Wall Mount, Double Shelf Support, 14"	3.5
RL898	Direct Wall Mount, Single Shelf Support, 18"	1.75
RL899	Direct Wall Mount, Double Shelf Support, 18"	3.25
RL900	Direct Wall Mount, Single Shelf Support, 24"	1.9
RL901	Direct Wall Mount, Double Shelf Support, 24"	3.56
RL614	Ledge For Shelf, 14"	0.6
RL615	Ledge For Shelf, 18"	0.75
RL616	Ledge For Shelf, 24"	1
RL617	Ledge For Shelf, 30"	2
RL618	Ledge For Shelf, 36"	2.5
RL619	Ledge For Shelf, 48"	3.5
RL620	Ledge For Shelf, 60"	3.75
RL621	Ledge For Shelf, 72"	4



RL054

Use S hooks to eliminate two posts per adjacent shelf. Two required per shelf.



RL055



RL050
Divider



RL612
Direct Wall Mount,
Single Shelf Support

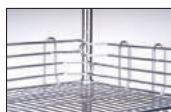

RL614
Ledge for Shelf

KLETON

COMPLETE SHELVING UNITS

Model No.	Type	Dimensions W" x D" x H"	Cap lbs. /Shelf*	Wt. lbs.
4 SHELVES				
RL907	Starter	30 x 14 x 63	800	39
RL908	Add-On	30 x 14 x 63	800	32
RL632	Starter	36 x 14 x 63	800	42.6
RL633	Add-On	36 x 14 x 63	800	35.5
RL634	Starter	48 x 14 x 63	800	49
RL635	Add-On	48 x 14 x 63	800	42
RL636	Starter	60 x 14 x 63	600	64.75
RL637	Add-On	60 x 14 x 63	600	57.75
RL638	Starter	72 x 14 x 63	600	71.5
RL639	Add-On	72 x 14 x 63	600	64.4
RL059	Starter	36 x 18 x 63	800	48
RL060	Add-On	36 x 18 x 63	800	35
RL061	Starter	48 x 18 x 63	800	58
RL062	Add-On	48 x 18 x 63	800	53.5
RL063	Starter	60 x 18 x 63	600	81
RL064	Add-On	60 x 18 x 63	600	76.5
RL065	Starter	72 x 18 x 63	600	91
RL066	Add-On	72 x 18 x 63	600	86.5
RL067	Starter	36 x 24 x 63	800	62
RL068	Add-On	36 x 24 x 63	800	57.5
RL069	Starter	48 x 24 x 63	800	74
RL070	Add-On	48 x 24 x 63	800	69.5
RL071	Starter	60 x 24 x 63	600	95
RL072	Add-On	60 x 24 x 63	600	90.5
RL073	Starter	72 x 24 x 63	600	117
RL074	Add-On	72 x 24 x 63	600	112.5
5 SHELVES				
RL909	Starter	30 x 14 x 74	800	47
RL910	Add-On	30 x 14 x 74	800	39
RL640	Starter	36 x 14 x 74	800	51
RL641	Add-On	36 x 14 x 74	800	43.46
RL642	Starter	48 x 14 x 74	800	59
RL643	Add-On	48 x 14 x 74	800	42.8
RL644	Starter	60 x 14 x 74	600	78.78
RL645	Add-On	60 x 14 x 74	600	71
RL646	Starter	72 x 14 x 74	600	87.3
RL647	Add-On	72 x 14 x 74	600	79.5
RL075	Starter	36 x 18 x 74	800	67.75
RL076	Add-On	36 x 18 x 74	800	58.25
RL077	Starter	48 x 18 x 74	800	80.25
RL078	Add-On	48 x 18 x 74	800	70.75
RL079	Starter	60 x 18 x 74	600	109
RL080	Add-On	60 x 18 x 74	600	99.5
RL081	Starter	72 x 18 x 74	600	121.5
RL082	Add-On	72 x 18 x 74	600	112
RL083	Starter	36 x 24 x 74	800	85.25
RL084	Add-On	36 x 24 x 74	800	75.75
RL085	Starter	48 x 24 x 74	800	100.25
RL086	Add-On	48 x 24 x 74	800	90.75
RL087	Starter	60 x 24 x 74	600	126.5
RL088	Add-On	60 x 24 x 74	600	117
RL089	Starter	72 x 24 x 74	600	154
RL090	Add-On	72 x 24 x 74	600	144.5
RL448	Starter	36 x 18 x 86	800	62
RL449	Add-On	36 x 18 x 86	800	53
RL450	Starter	48 x 18 x 86	800	69
RL451	Add-On	48 x 18 x 86	800	60
RL452	Starter	60 x 18 x 86	600	91.5
RL453	Add-On	60 x 18 x 86	600	82
RL454	Starter	72 x 18 x 86	600	96
RL455	Add-On	72 x 18 x 86	600	87
RL456	Starter	36 x 24 x 86	800	74
RL457	Add-On	36 x 24 x 86	800	65
RL458	Starter	48 x 24 x 86	800	90
RL459	Add-On	48 x 24 x 86	800	80
RL460	Starter	60 x 24 x 86	600	107
RL461	Add-On	60 x 24 x 86	600	97
RL462	Starter	72 x 24 x 86	600	129
RL463	Add-On	72 x 24 x 86	600	120

* Evenly distributed weight



WIRE SHELVING UNITS WITH STORAGE BINS

Same great features as the Kleton chrome wire shelving, but with the added convenience of heavy-duty storage bins.

- Adjustable chrome wire shelves
- Wire shelving resists corrosion and provides greater visibility to stored parts
- Wire shelves prevent build up of dust and dirt
- Bins are unaffected by oil, alkaline, and most acids
- Ideal in production or for parts storage

Model No.	No. of Shelves	Shelving Dim.			Bin Dim.			No. of Bins	Colour
		W"	D"	H"	W"	D"	H"		
RL823	5	36	24	74	15 1/2	25	13	8	Blue
RL824	5	36	24	74	15 1/2	25	13	8	Yellow
RL825	5	36	24	74	15 1/2	25	13	8	Green
RL826	5	36	24	74	15 1/2	25	13	8	Red
RL835	5	48	24	74	7 7/8	17 11/16	7	4	Blue
					11 13/16	17 11/16	7	7	Blue
					15 1/2	25	13	6	Blue
RL836	5	48	24	74	7 7/8	17 11/16	7	4	Yellow
					11 13/16	17 11/16	7	7	Yellow
					15 1/2	25	13	6	Yellow
RL837	5	48	24	74	7 7/8	17 11/16	7	4	Green
					11 13/16	17 11/16	7	7	Green
					15 1/2	25	13	6	Green
RL838	5	48	24	74	7 7/8	17 11/16	7	4	Red
					11 13/16	17 11/16	7	7	Red
					15 1/2	25	13	6	Red



RL826



RL837

GREEN EPOXY FINISH WIRE SHELVING

- Ideal for use in wet environments
- Superior rust resistance
- Designed to minimize dust, improve air circulation, and provide greater visibility of stored items
- Post's circular grooves combined with tapered plastic sleeves allow for assembly in minutes with no special tools
- Shelf ribs run front to back allowing items to slide on and off shelves smoothly
- Shelves can be adjusted at precise 1" intervals
- Posts are double grooved every 8" and numbered for easy adjustment
- Adjustable feet compensate for surface irregularities
- Stationary unit's total capacity should not exceed 2000 lbs.
- NSF certified



RL648

WIRE SHELVES

Model No.	Dimensions W" x D"	Cap lbs. /Shelf*
RN082	30 x 14	800
RN083	36 x 14	800
RN084	48 x 14	800
RN085	60 x 14	600
RN086	72 x 14	600
RN087	30 x 18	800
RL622	36 x 18	800
RL623	48 x 18	800
RL624	60 x 18	600
RL625	72 x 18	600
RL626	36 x 24	800
RL627	48 x 24	800
RL628	60 x 24	600

* Evenly distributed weight

POSTS

Model No.	Height"
RL629	63
RL630	74
RL631	86

COMPLETE SHELVING UNITS

Model No.	Type	Dimensions			Cap. lbs. /Shelf
		W"	x	D" x H"	
4 SHELVES					
RN089	Starter	30	x	14 x 63	800
RN090	Add-On	30	x	14 x 63	800
RN091	Starter	36	x	14 x 63	800
RN092	Add-On	36	x	14 x 63	800
RN093	Starter	48	x	14 x 63	800
RN094	Add-On	48	x	14 x 63	800
RN095	Starter	60	x	14 x 63	600
RN096	Add-On	60	x	14 x 63	600
RN097	Starter	72	x	14 x 63	600
RN098	Add-On	72	x	14 x 63	600
RL648	Starter	36	x	18 x 63	800
RL649	Add-On	36	x	18 x 63	800
RL650	Starter	48	x	18 x 63	800
RL651	Add-On	48	x	18 x 63	800
RL652	Starter	60	x	18 x 63	600
RL653	Add-On	60	x	18 x 63	600
RL654	Starter	72	x	18 x 63	600
RL655	Add-On	72	x	18 x 63	600
RL656	Starter	36	x	24 x 63	800
RL657	Add-On	36	x	24 x 63	800
RL658	Starter	48	x	24 x 63	800
RL659	Add-On	48	x	24 x 63	800
RL660	Starter	60	x	24 x 63	600
RL661	Add-On	60	x	24 x 63	600
RN099	Starter	72	x	24 x 63	600
RN100	Add-On	72	x	24 x 63	600
5 SHELVES					
RL662	Starter	36	x	18 x 74	800
RL663	Add-On	36	x	18 x 74	800
RL664	Starter	48	x	18 x 74	800
RL665	Add-On	48	x	18 x 74	800
RL666	Starter	60	x	18 x 74	600
RL667	Add-On	60	x	18 x 74	600
RL668	Starter	72	x	18 x 74	600
RL669	Add-On	72	x	18 x 74	600
RL670	Starter	36	x	24 x 74	800
RL671	Add-On	36	x	24 x 74	800
RL672	Starter	48	x	24 x 74	800
RL673	Add-On	48	x	24 x 74	800
RL674	Starter	60	x	24 x 74	600
RL675	Add-On	60	x	24 x 74	600
RN111	Starter	72	x	24 x 74	600
RN112	Add-On	72	x	24 x 74	600

WIRE SHELF CARTS

GREEN EPOXY WIRE SHELF CARTS

- Ideal for use in wet environments
- Superior rust resistance
- Designed to minimize dust, improve air circulation, and provide greater visibility of stored items
- Shelves can be adjusted quickly and easily
- Strong and versatile
- **Includes:** 5" resilient rubber casters (two swivel, two with brake)
- Capacity: 600 lbs. evenly distributed
- 1-year limited warranty
- Shipped knocked-down
- NSF certified

KLETON

Model No.	Dimensions			Wt. lbs.
	W"	D"	H"	
4 SHELVES				
RL129	36	18	63	60
RL130	48	18	63	72
RL131	60	18	63	88
RL803	36	18	74	64
RL804	48	18	74	74
RL805	60	18	74	94
RL806	36	24	74	78
RL807	48	24	74	90
RL808	60	24	74	110
5 SHELVES				
RL809	36	18	86	68
RL810	48	18	86	78
RL811	60	18	86	98
RL812	36	24	86	82
RL813	48	24	86	94
RL814	60	24	86	114



WIRE SHELF CARTS

- Open-wire shelf design minimizes dust and increases air circulation and visibility
- High quality chromate shelves and posts prevent corrosion
- Shelves can be adjusted easily and quickly
- Capacity: 600 lbs. evenly distributed weight
- **Includes:** 5" resilient rubber casters (two swivel, two with brake)
- 1-year limited warranty
- Shipped knocked down
- NSF certified

KLETON

Model No.	Dimensions			Wt. lbs.
	W"	D"	H"	
4 SHELVES				
RL600	36	18	63	56
RL601	48	18	63	65
RL602	60	18	63	83
MJ527	36	18	74	64
MJ528	48	18	74	74
MJ529	60	18	74	94
RL603	36	24	63	69
RL604	48	24	63	81
RL605	60	24	63	95
MJ530	36	24	74	78
MJ531	48	24	74	90
MJ532	60	24	74	110
5 SHELVES				
MJ533	36	18	86	68
MJ534	48	18	86	78
MJ535	60	18	86	98
MJ536	36	24	86	82
MJ537	48	24	86	94
MJ538	60	24	86	114



STANDARD DUTY UTILITY CARTS

- Durable, dependable transport solution that is easy to manoeuvre
- Highly rigid construction lets you easily adjust at 1" increments
- Durable chromate handles, shelves and posts
- Capacity: 600 lbs. evenly distributed weight
- **Includes:** Two handles, indicated number of shelves, and casters
- 1-year limited warranty
- Shipped knocked down
- NSF certified



KLETON

Model No.	Dimensions			Wt. lbs.
	W"	D"	H"	
2 SHELVES				
MK781	30	18	39	36.5
MK782	36	18	39	40.25
MK783	48	18	39	44.75
MK784	60	18	39	54
MK785	36	24	39	47.75
MK786	48	24	39	53.75
MK787	60	24	39	63.5
3 SHELVES				
MJ539	30	18	39	45
MJ540	36	18	39	50
MJ541	48	18	39	57
MJ542	60	18	39	72
MJ543	36	24	39	61
MJ544	48	24	39	70
MJ545	60	24	39	85

PUSH CARTS

- Durable, dependable transport solution
- Easy maneuverability
- Shelves can be adjusted quickly and easily
- Capacity: 600 lbs. evenly distributed
- 1-year limited warranty
- Shipped knocked down
- NSF certified



KLETON

Model No.	Dimensions			Wt. lbs.
	W"	D"	H"	
4 SHELVES				
RL914	30	14	54	
RL915	36	14	54	
RL916	48	14	54	
RL917	60	14	54	
5 SHELVES				
RL918	30	14	54	
RL919	36	14	54	
RL920	48	14	54	
RL921	60	14	54	

KLETON STACK & HANG BINS

- Designed to hang from bin racks, panels, rails and carts
- Bins reduce and control inventories, shorten assembly times and minimize parts handling
- Reinforced ribs, on both sides, prevent bins from spreading under loads
- Front, back and side grips for easy handling
- Stackable

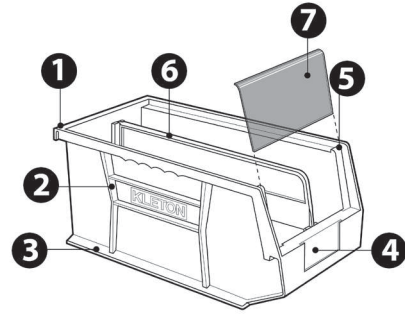
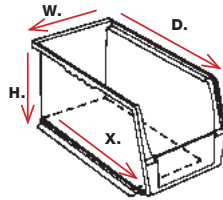
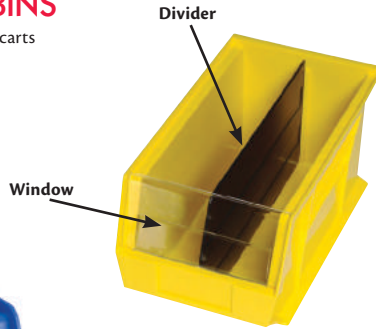

1. Full width hanger supports bins when suspended from louvered panels or rails
2. Reinforced rib design adds strength and prevents spreading when stacked
3. Extra-wide ledges for secure stacking and stability
4. Large front label slots ideal for larger bar code scanning and content identification
5. Anti-slide stop prevents stacked bins from shifting forward
6. Optional dividers increase storage options
7. Optional windows maximize storage capacity, prevent spillage and protect parts from dust and dirt

Blue	Red	Yellow	Green	Black	Series	Outside Dimensions			Inside Dimensions			Inside Bottom Depth X"	Bin Load Capacity lbs.	Uses Divider	Uses Clear Window
						W"	x D"	x H"	W"	x D"	x H"				
CF820	CF822	CF823	CF821	CF824	30210	4-1/8	x 5-3/8	x 3	3-7/16	x 4-3/4	x 2-13/16	4	10	CB825	-
CF825	CF827	CF828	CF826	CF829	30220	4-1/8	x 7-3/8	x 3	3-7/16	x 6-3/4	x 2-13/16	6	10	CB826	-
CF830	CF832	CF833	CF831	CF834	30230	5-1/2	x 10-7/8	x 5	4-3/8	x 10-1/4	x 4-3/4	9	30	CB829	CB814
CF835	CF837	CF838	CF836	CF839	30235	11	x 10-7/8	x 5	10	x 10-1/4	x 4-3/4	9	50	CB829	CB815
CF840	CF842	CF843	CF841	CF844	30239	8-1/4	x 10-3/4	x 7	6-9/16	x 10	x 6-3/4	8	50	CB830	CB818
CF845	CF847	CF848	CF846	CF849	30240	8-1/4	x 14-3/4	x 7	6-9/16	x 14	x 6-3/4	12	60	CB831	CB818
CF850	CF852	CF853	CF851	CF854	30250	16-1/2	x 14-3/4	x 7	14-3/4	x 14	x 6-3/4	12	75	CB831	CB819

DIVIDERS

- Maximizes flexibility, keeps contents organized
- Allows for the separation of contents in bins
- Installed in a back to front position



Model No.	Description	Dividers per Case
CB825	For 5-3/8" D x 3" H Bin	6
CB826	For 7-3/8" D x 3" H Bin	6
CB829	For 10-7/8" D x 5" H Bin	6
CB830	For 10-3/4" D x 7" H Bin	6
CB831	For 14-3/4" D x 7" H Bin	6

CLEAR WINDOWS

- Crystal styrene window front increases bin capacity
- Provides quick view on bin contents
- Snaps quickly into place



Model No.	Description	Windows per Case
CB814	5-1/2" W x 5" H	12
CB815	11" W x 5" H	6
CB818	8-1/4" W x 7" H	6
CB819	16-1/2" W x 7" H	6

BIN BUDDY™ & TRI-DEX™ LABEL HOLDERS

- Clear self-adhesive backing adheres to any plastic or metal container
- Clear bar code compatible window protects label from dirt and moisture
- Tri-Dex™ label holders snap into bin slots protecting label or barcode
- Includes a set of laser/ink jet compatible labels, 25/pack
- Extra refill labels are also available, sold 50/pack

Bin not included



OK113



Model No.	Mfg. No.	Dimensions"	Description	Refill Labels
OF212	BB-13	1 x 3	Bin Buddy™, Top/Bottom load, Self Adhesive	OF216
OF210	BB-35	3 x 5	Bin Buddy™, Side Load, Self Adhesive	OF214
OK113	TR-0813	13/16 x 3	Tri-Dex™, Ideal for Shelf Bins	OK118
OK114	TR-1300	1 x 3	Tri-Dex™, Ideal for Bin Series 30-210, 30-220	OK119
OK116	TR-1754	1 3/4 x 4	Tri-Dex™, Ideal for Bin Series 30-230, 30-250	OK121

CLEAR COVER

- Provides high visibility and accessibility to bin contents
- Easy snap-in installation due to integrated hinge pins
- Clear covers protects from dust, dirt, and debris
- Can be used with dividers



Model No.	Description	Covers per Case
CF855	For 5-3/8" D x 4-1/8" W x 3" H Bin	24
CF856	For 7-3/8" D x 4-1/8" W x 3" H Bin	24
CF857	For 10-7/8" D x 5-1/2" W x 5" H Bin	12
CF858	For 10-7/8" D x 11" W x 5" H Bin	6
CF859	For 10-3/4" D x 8-1/4" W x 7" H Bin	6
CF860	For 14-3/4" D x 8-1/4" W x 7" H Bin	12

BINS

HI-STAK PLASTIC BINS

- Innovative stacking design allows for greater visibility and easier access to contents
- Distortion-free from -40°C to 120°C
- Unaffected by oil, alkaline and most acids
- Ideal in production or for store display
- Included with each bin: I.D. card with clear plastic shield, four riser legs and connector clip

KLETON



Connector clip allows for back-to-back mounting



1" riser legs increase loading capacity and stability



Inclined faceplate with removable label and protector

Built-in extrusions allow side-by-side interlock



Stackable using built-in feet



Model No.				Dimensions					Qty	Wt.
Blue	Yellow	Green	Red	W"	x	D"	x	H"	/Case	lbs.
CB260	CB261	CC234	CC242	4 13/16	x	7 1/8	x	3 3/16	60	0.10
CB262	CB263	CC235	CC243	5 7/8	x	9 13/16	x	4 11/16	36	0.15
CB264	CB265	CC236	CC244	8 3/16	x	14	x	6 3/16	18	0.35
CC239	CC240	CC237	CC245	7 7/8	x	17 11/16	x	7	12	0.55
CB266	CB267	CC238	CC246	11 13/16	x	17 11/16	x	7	8	0.60

Add 1 inch to overall height when stacking on legs

WIRE SHELVING UNITS WITH STORAGE BINS

Same great features as the Kleton chromate wire shelving, but with the added convenience of heavy-duty storage bins.

- Adjustable chromate wire shelves
- Wire shelving resists corrosion and provides greater visibility to stored parts
- Wire shelves prevent build up of dust and dirt
- Bins are unaffected by oil, alkaline, and most acids
- Ideal in production or for parts storage
- Stationary units total capacity should not exceed 2000 lbs.
- NSF Certified (wire shelving units only)
- Assembly required

KLETON



RL815



RL820

Model No.	Shelving Dim. W" x D" x H"	No. of Shelves	Bin Dimensions					No. of Bins	Colour
			W"	x	D"	x	H"		
RL815	36 x 14 x 74	8	8 3/16	x	14	x	6 3/16	28	Blue
RL816	36 x 14 x 74	8	8 3/16	x	14	x	6 3/16	28	Yellow
RL817	36 x 14 x 74	8	8 3/16	x	14	x	6 3/16	28	Green
RL818	36 x 14 x 74	8	8 3/16	x	14	x	6 3/16	28	Red
RL819	36 x 18 x 74	8	7 7/8	x	17 11/16	x	7	28	Blue
RL820	36 x 18 x 74	8	7 7/8	x	17 11/16	x	7	28	Yellow
RL821	36 x 18 x 74	8	7 7/8	x	17 11/16	x	7	28	Green
RL822	36 x 18 x 74	8	7 7/8	x	17 11/16	x	7	28	Red
RL827	48 x 18 x 74	8	7 7/8	x	17 11/16	x	7	28	Blue
			11 13/16	x	17 11/16	x	7	7	Blue
RL828	48 x 18 x 74	8	7 7/8	x	17 11/16	x	7	28	Yellow
			11 13/16	x	17 11/16	x	7	7	Yellow
RL829	48 x 18 x 74	8	7 7/8	x	17 11/16	x	7	28	Green
			11 13/16	x	17 11/16	x	7	7	Green
RL830	48 x 18 x 74	8	7 7/8	x	17 11/16	x	7	28	Red
			11 13/16	x	17 11/16	x	7	7	Red
RL831	48 x 18 x 74	8	7 7/8	x	17 11/16	x	7	7	Blue
			11 13/16	x	17 11/16	x	7	21	Blue
RL832	48 x 18 x 74	8	7 7/8	x	17 11/16	x	7	7	Yellow
			11 13/16	x	17 11/16	x	7	21	Yellow
RL833	48 x 18 x 74	8	7 7/8	x	17 11/16	x	7	7	Green
			11 13/16	x	17 11/16	x	7	21	Green
RL834	48 x 18 x 74	8	7 7/8	x	17 11/16	x	7	7	Red
			11 13/16	x	17 11/16	x	7	21	Red
RL839	36 x 18 x 74	8	7 7/8	x	17 11/16	x	7	7	Blue
			11 13/16	x	17 11/16	x	7	14	Blue
RL840	36 x 18 x 74	8	7 7/8	x	17 11/16	x	7	7	Yellow
			11 13/16	x	17 11/16	x	7	14	Yellow
RL841	36 x 18 x 74	8	7 7/8	x	17 11/16	x	7	7	Green
			11 13/16	x	17 11/16	x	7	14	Green
RL842	36 x 18 x 74	8	7 7/8	x	17 11/16	x	7	7	Red
			11 13/16	x	17 11/16	x	7	14	Red

QUANTUM™ BINS

- Heavy-duty, virgin, high density polypropylene/polyethylene
- Autoclavable up to 250°F
- Large multiple label slots • Stackable
- Optional dividers and clear windows available for most units
- Hangs on louvered panels, rails and carts
- Jumbo bins cannot hang on louvered panels or rail systems
- Jumbo bins have a stack capacity of up to 100 lbs. and can stack up to six bins high
- Mobile bins come with four swivel 3" casters with brakes
- Made of FDA approved materials

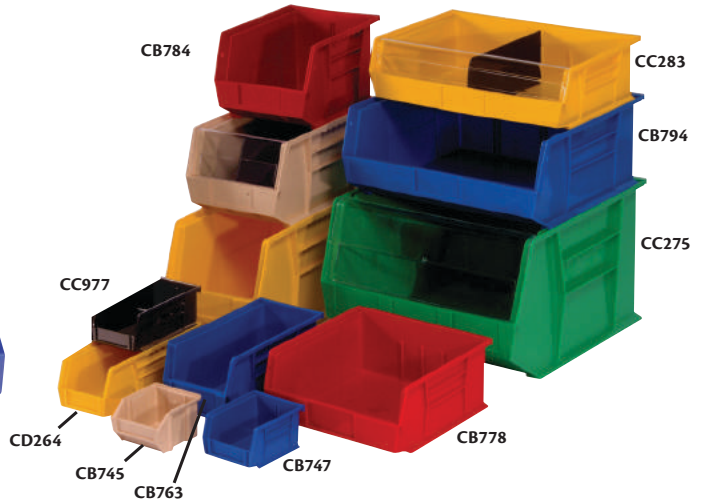

Black	Blue	Model No.				Mfg. No.	Outside Dimensions				Qty /Case	Bin load Cap. lbs.	Divider Model No.	Clear Window Model No.	
		Yellow	Red	Ivory	Green		W"	x	D"	x	H"				
CC975	CB739	CB741	CB744	CB745	CC264	QUS 200	4 1/8	x	5	x	3	24	8	CB824	-
CC976	CB747	CB750	CB751	CB753	CC265	QUS 210	4 1/8	x	5 3/8	x	3	24	10	CB825	-
CC977	CB756	CB757	CB759	CB762	CC266	QUS 220	4 1/8	x	7 3/8	x	3	24	10	CB826	-
CF376	CF377	CF378	CF379	CF380	CF381	QUS 221	6	x	9 1/4	x	5	12	20	CF501	CF560
CD276	CD249	CD262	CD263	CD264	CD265	QUS 224	4 1/8	x	10 7/8	x	4	12	30	CD250	CD266
CC978	CB763	CB765	CB766	CB768	CC267	QUS 230	5 1/2	x	10 7/8	x	5	12	30	CB829	CB814
CC974	CC971	CC972	CC973	CC990	CC970	QUS 234	5 1/2	x	14 3/4	x	5	12	50	CC569	CB814
CC980	CB775	CB777	CB778	CB780	CC269	QUS 235	11	x	10 7/8	x	5	6	50	CB829	CB815
CC576	CB781	CB783	CB784	CB786	CC270	QUS 239	8 1/4	x	10 3/4	x	7	6	50	CB830	CB818
CC577	CB787	CB789	CB790	CB792	CC271	QUS 240	8 1/4	x	14 3/4	x	7	12	60	CB831	CB818
CF382	CF383	CF384	CF385	CF386	CF387	QUS 241	8 1/4	x	13 5/8	x	6	12	60	CF394	CF396
CF388	CF389	CF390	CF391	CF392	CF393	QUS 242	8 1/4	x	13 5/8	x	8	12	60	CF395	CF397
CC983	CC282	CC283	CC284	CC285	CC286	QUS 245	16 1/2	x	10 7/8	x	5	6	60	CC297	CC300
CC578	CB794	CB795	CB796	CB802	CC272	QUS 250	16 1/2	x	14 3/4	x	7	6	75	CB831	CB819
CC579	CB798	CB800	CB801	CB802	CC273	QUS 255	11	x	16	x	8	4	75	CB833	CB820
CC580	CB803	CB804	CB806	CB807	CC274	QUS 260	11	x	18	x	10	4	75	CB834	CB821
CC581	CC287	CC288	CC289	CC290	CC291	QUS 265	8 1/4	x	18	x	9	6	60	CC298	CC301
CC582	CB808	CB809	CB810	CB811	CC275	QUS 270	16 1/2	x	18	x	11	3	75	CB835	CB822
CD674*	CD669*	CD670*	CD671*	CD673*	CD672*	QUS 275MOB	16 1/2	x	18	x	14	3	-	CB835	CB822

* Mobile unit

OPEN HOPPER STORAGE SHELF UNITS

QUS 239 SERIES

- 28 QUS 239 Series bins 8 1/4" W x 10 3/4" D x 7" H
- Eight heavy-duty grey enamel shelves
- 36" W x 12" D x 76" H
- Cap.: 630 lbs. per shelf
- Shipped knocked down



CF118

QUS 240 SERIES

- 28 QUS 240 Series bins 8 1/4" W x 14 3/4" D x 7" H
- Eight heavy-duty grey enamel shelves
- 36" W x 12" D x 76" H
- Cap.: 630 lbs. per shelf
- Shipped knocked down



CF126

QUS 250 SERIES

- 14 QUS 250 Series bins 16 1/2" W x 14 3/4" D x 7" H
- Eight heavy-duty grey enamel shelves
- 36" W x 12" D x 76" H
- Cap.: 630 lbs. per shelf
- Shipped knocked down



CF132

QUS 240 & 230 SERIES

- 8 QUS 240 Series bins 8 1/4" W x 14 3/4" D x 7" H
- 36 QUS 230 Series bins 5 1/2" W x 10 7/8" D x 5" H
- Nine heavy-duty grey enamel shelves
- 36" W x 12" D x 76" H
- Cap.: 630 lbs. per shelf
- Shipped knocked down



CF135

Black	Blue	Model No.				Description	No. of Shelves
		Yellow	Red	Ivory	Green		
QUS 239 SERIES BINS SHELF UNIT							
CF176	CF118	CF119	CF120	CF121	CF122	Starter	8
CF180	CF140	CF141	CF142	CF143	CF144	Add-On	8
QUS 240 SERIES BINS SHELF UNIT							
CF178	CF123	CF124	CF125	CF126	CF127	Starter	8
CF182	CF150	CF151	CF152	CF153	CF154	Add-On	8

Black	Blue	Model No.				Description	No. of Shelves
		Yellow	Red	Ivory	Green		
QUS 250 SERIES BINS SHELF UNIT							
CF177	CF128	CF129	CF130	CF131	CF132	Starter	8
CF181	CF145	CF146	CF147	CF148	CF149	Add-On	8
QUS 240 & 230 SERIES BINS SHELF UNIT							
CF179	CF133	CF134	CF135	CF136	CF137	Starter	9
CF183	CF175	CF155	CF156	CF157	CF158	Add-On	9

SHELF BINS

SHELF BINS

- Economical way to store and display parts and components
- Durable polypropylene
- Designed for use on 12", 18" and 24" deep shelving, or vertical storage and retrieval units
- Shelf bins "nest" when empty
- Bin cups and dividers available
- Manufactured from FDA approved polypropylene

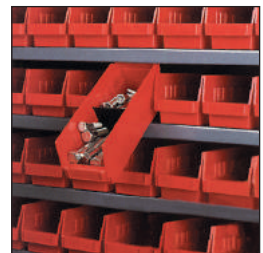
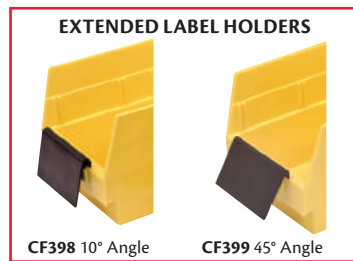
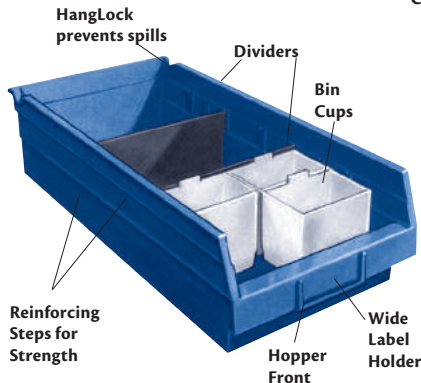
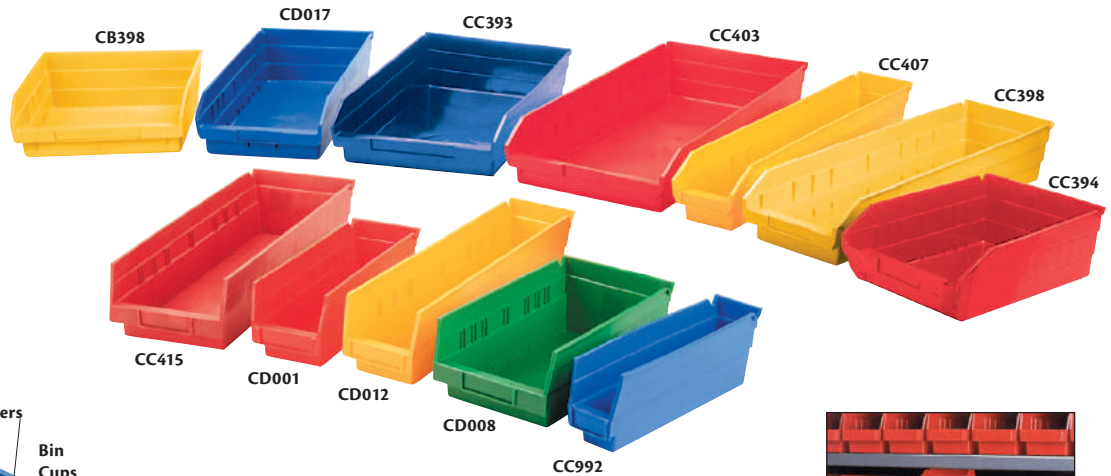

The special built-in hanglock catches the underside of the shelf above, allowing each bin to be tilted out for complete access.

Blue		Red		Model No.		Clear		Green		Mfg. No.		Outside Dimensions			Inside Dimensions			Qty /Case	Dividers, up to 7 per bin	Bin Cups Per Bin			
Model No.	Mfg. No.	Model No.	Mfg. No.	Model No.	Mfg. No.	Model No.	Mfg. No.	Model No.	Mfg. No.	Model No.	Mfg. No.	W" x D" x H"	W" x D" x H"	W" x D" x H"	W" x D" x H"	W" x D" x H"	W" x D" x H"	W" x D" x H"	W" x D" x H"	CD035	CD040	CD036	CD041
CC992	CC994	CC993	N/A	CC995	QSB100	2 3/4	x	11 5/8	x	4	1 5/8	x	10 1/4	x	4	24	N/A	3	N/A	3	N/A		
CC998	CD001	CC999	N/A	CD002	QSB101	4 1/8	x	11 5/8	x	4	3	x	10 1/4	x	4	24	CB861	6	2	6	2		
CD005	CD007	CD006	N/A	CD008	QSB102	6 5/8	x	11 5/8	x	4	5 1/2	x	10 1/4	x	4	12	CB862	9	4	N/A	N/A		
CC393	CC394	CC395	CF531	CD023	QSB107	8 3/8	x	11 5/8	x	4	7 1/2	x	10 3/4	x	3 7/8	20	CB867	12	4	12	4		
CC396	CC397	CC398	CF532	CD026	QSB109	11 1/8	x	11 5/8	x	4	10 3/8	x	10 3/4	x	3 7/8	8	CB869	18	6	18	6		
CD011	CD013	CD012	N/A	CD014	QSB103	4 1/8	x	17 7/8	x	4	3	x	16 1/2	x	4	12	CB861	9	3	9	3		
CD017	CD019	CD018	N/A	CD020	QSB104	6 5/8	x	17 7/8	x	4	5 1/2	x	16 1/2	x	4	12	CB862	15	6	15	6		
CC399	CC400	CC401	CF533	CD029	QSB108	8 3/8	x	17 7/8	x	4	7 1/2	x	16 1/2	x	3 7/8	10	CB867	19	6	19	6		
CC402	CC403	CC404	CF534	CD032	QSB110	11 1/8	x	17 7/8	x	4	10 3/8	x	16 3/8	x	3 7/8	8	CB869	29	8	29	8		
CC405	CC406	CC407	CF535	CD045	QSB105	4 1/8	x	23 5/8	x	4	3 1/4	x	22 1/4	x	3 7/8	8	CB861	13	4	13	4		
CC408	CC409	CC423	CF536	CD048	QSB106	6 5/8	x	23 5/8	x	4	5 1/2	x	22 1/4	x	3 7/8	8	CB862	21	8	21	8		
CC411	CC412	CC413	CF537	CD051	QSB114	8 3/8	x	23 5/8	x	4	7 1/2	x	22 1/4	x	3 7/8	6	CB867	24	8	24	8		
CC414	CC415	CC416	CF538	CD054	QSB116	11 1/8	x	23 5/8	x	4	10 3/8	x	22 1/4	x	3 7/8	6	CB869	35	16	35	16		

BIN DIVIDERS

Model No.	Mfg. No.	Width"	Qty/Case
CB861	DSB101/DSB103	4 1/8	50
CB862	DSB102/DSB103	6 5/8	50
CB867	DSB107	8 1/8	50
CB869	DSB109	11 1/8	50

BIN CUPS

Model No	Mfg. No.	Colour	Dimensions
CD035	QBC111	Blue	3 1/4" x 1 3/4"
CD040	QBC112	Blue	5 1/8" x 2 3/4"
CD036	QBC111	Yellow	3 1/4" x 1 3/4"
CD041	QBC112	Yellow	5 1/8" x 2 3/4"

EXTENDED LABEL HOLDERS, 24 PER BOX

Model No	Mfg. No.	Colour	Angle
CF398	ELH410	Black	10°
CF399	ELH415	Black	45°

RECYCLED SHELF BINS

- Manufactured from recycled 100% post consumer, high density polyethylene
- Available in black only

Model No.	Mfg. No.	Outside Dimensions W" x D" x H"	Qty /Case	Dividers*, up to 7 per bin Model No.
CC303	QSB100BR	2 3/4 x 11 5/8 x 4	48	N/A
CB850	QSB101BR	4 1/8 x 11 5/8 x 4	36	CB861
CB851	QSB102BR	6 5/8 x 11 5/8 x 4	30	CB862
CB852	QSB103BR	4 1/8 x 17 7/8 x 4	24	CB861
CB954	QSB104BR	6 5/8 x 17 7/8 x 4	20	CB862
CB854	QSB105BR	4 1/8 x 23 5/8 x 4	8	CB861
CB855	QSB106BR	6 5/8 x 23 5/8 x 4	8	CB862
CB857	QSB108BR	8 3/8 x 17 7/8 x 4	10	CB867
CB860	QSB114BR	8 1/8 x 23 5/8 x 4	6	CB867
CB304	QSB116BR	11 1/8 x 23 5/8 x 4	6	CB869

* Dividers are made of non-recycled polyethylene

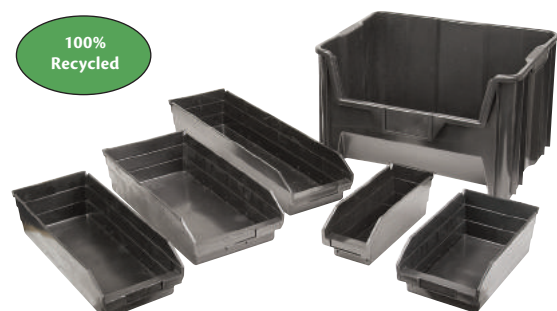

SHELF BINS & CONTAINERS

EURO DRAWERS

- Heavy-duty design for efficient organization of heavy parts, supplies, tools or equipment
- Injection molded from virgin grade high-impact polystyrene
- 12-gauge thick wall
- Completely waterproof
- Oil and chemical-resistant
- Smooth front curved pull handle has ample room for pressure sensitive identification labels or bar codes
- Front handle has 3/4" opening
- Full width back ledge ensures spill free use

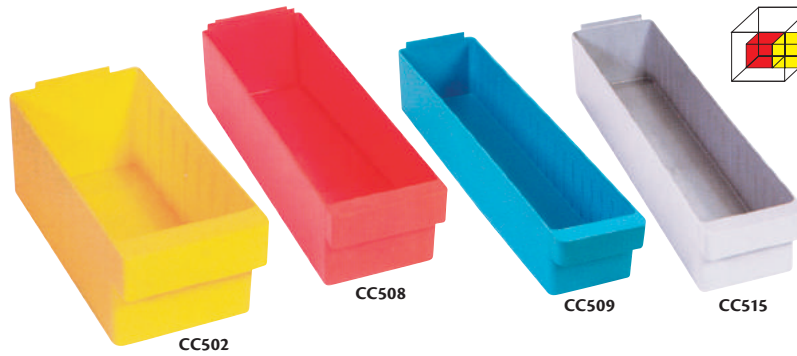

Model No.				Mfg. No.	Outside Dimensions			Qty /Case	Divider Model No.
Blue	Grey	Red	Yellow		W"	x D"	x H"		
CE289	CE291	CE292	CE290	QED401	5 9/16	x 11 5/8	x 2 5/8	24	CE309
CE293	CE295	CE296	CE294	QED501	3 3/4	x 11 5/8	x 4 5/8	24	CC518
CC501	CC503	CC504	CC502	QED601	5 9/16	x 11 5/8	x 4 5/8	24	CC517
CC505	CC507	CC508	CC506	QED602	5 9/16	x 17 5/8	x 4 5/8	24	CC517
CC509	CC511	CC512	CC510	QED603	5 9/16	x 23 7/8	x 4 5/8	12	CC517
CC513	CC515	CC516	CC514	QED604	3 3/4	x 17 5/8	x 4 5/8	24	CC518
CE305	CE307	CE308	CE306	QED606	8 3/8	x 17 5/8	x 4 5/8	24	CE312
CE297	CE299	CE300	CE298	QED701	8 3/8	x 11 5/8	x 4 5/8	24	CE312
CE301	CE303	CE304	CE302	QED801	11 1/8	x 11 5/8	x 4 5/8	12	CE314

Add dividers to Euro Drawers for additional storage possibilities!



GIANT STACKING CONTAINERS

- Designed for multiple applications in recycling, storing parts, tools and warehouse items
- Will stack up to six high creating sturdy, tall storage systems
- Large grip side handles
- Extra thick side walls with reinforcing ribs allow for 100-lb. stack capacity per bin
- Six 1/4" drill holes in bottom allow for drainage
- Outside dimensions: 15 1/4" L x 19 7/8" W x 12 7/16" H
- Optional clear window and labels are available



Model No.					Mfg. No.	Qty /Case
Grey	Blue	Ivory	Black	Red		
CB838	CB839	CB841	CB842	CC305	QGH700	3



JUMBO PLASTIC CONTAINERS

- Extra-large size provides massive amount of storage capacity
- Guaranteed unbreakable and distortion-free from -40°C to 120°C
- Unaffected by oil, alkaline, and most acids
- Nesting design allows for minimal storage space when not in use
- Stackable for added space savings, up to four high
- Outside Dimensions: 15 1/2" W x 25" D x 13" H
- Capacity: 200 lbs.



Model No.	Colour
CF328	Blue
CF330	Yellow

Model No.	Colour
CF329	Green
CF327	Red

STACK-N-NEST® STORAGE BINS

- Great for storing, assembling and transporting small parts, components and finished goods
- Designed for maximum efficiency and utility
- Set together one way they stack and the other way they nest
- May be used on shelving or stacked up
- Heavy-duty design allows higher stacking
- In the plant, use the same bin for storage, handling, and assembly, no need to transfer contents



Model No.	Colour	Outside Dimensions			Wt. lbs.
		W"	x D"	x H"	
CC890	Blue	12 1/4	x 15 1/4	x 6	2
CC892	Yellow	12 1/4	x 15 1/4	x 6	2

CONTAINERS

GIANT STACKING CONTAINERS

- Injection-molded from high density polyethylene
- Extra heavy, double wall thickness with interlock preformed lip allows containers to stack securely
- Molded carrying handle on backside
- Molded-in divider and label slots
- Optional windows available
- Can withstand temperatures ranging from -40° to 250°F
- Waterproof, will not rust or corrode
- Unaffected by chemicals and solvents
- Mobile bin comes with two swivel, two rigid 3" casters
- 250-lb. mobile capacity
- 150-lb. stack capacity

MAGNUM

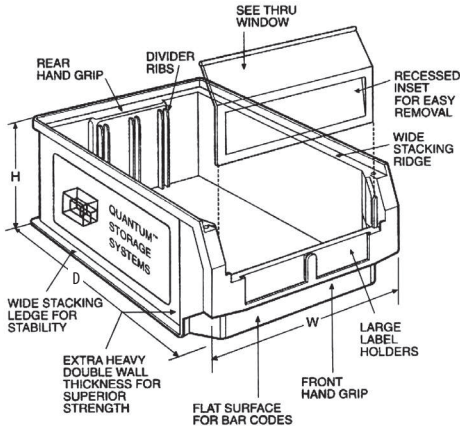

Model No.				Mfg. No.	Outside Dimensions				Qty /Case
Blue	Green	Red	Yellow		W"	x D"	x H"		
CC361	CC362	CC363	CC364	QMS531	12 3/8	x 19 3/4	x 5 7/8	6	
CC365	CC366	CC367	CC368	QMS532	12 3/8	x 19 3/4	x 7 7/8	6	
CC369	CC370	CC371	CC372	QMS533	12 3/8	x 19 3/4	x 11 7/8	3	
CC373	CC374	CC375	CC376	QMS543	18 3/8	x 19 3/4	x 11 7/8	3	
CC377*	CC378*	CC379*	CC380*	QMS743	18 3/8	x 29	x 11 7/8	1	
CC447*	CC449*	CC448*	CC450*	QMS843MOB**	18 3/8	x 29	x 11 7/8	1	

* Includes heavy-duty spread bar for extra strength and support. ** Mobile bins

Divider Model No.	Qty /Case	Window Model No.	Qty /Case
CC381	6	CC385	12
CC382	6	CC386	6
CC383	3	CC387	6
CC384	3	CC388	6
-	-	-	-
-	-	-	-

QUANTUM™ HULK CONTAINERS

- Heavy-duty injection-molded polypropylene stackable containers
- Organize and store your larger bulky items
- Extra large stacking containers offer a generous 2 to 2 1/2' in length to store your larger items
- Ideal for back-to-back use on 48" pallet rack or heavy-duty, extra deep shelving, and are available in a variety of widths and heights
- Heavy-duty front, back and side grips allow for easy handling
- Optional clear plastic window increases bin capacity and provides a quick view of the bin contents
- Optional dividers maximize flexibility and keep contents organized
- Wide stacking ledge and anti-slide lock keep stacked bins steady and prevent forward shifting
- Waterproof bins resist rust and corrosion
- Bins are autoclavable up to 250°F and are resistant to extreme cold
- **Do not hang on louvered panels or rail systems**

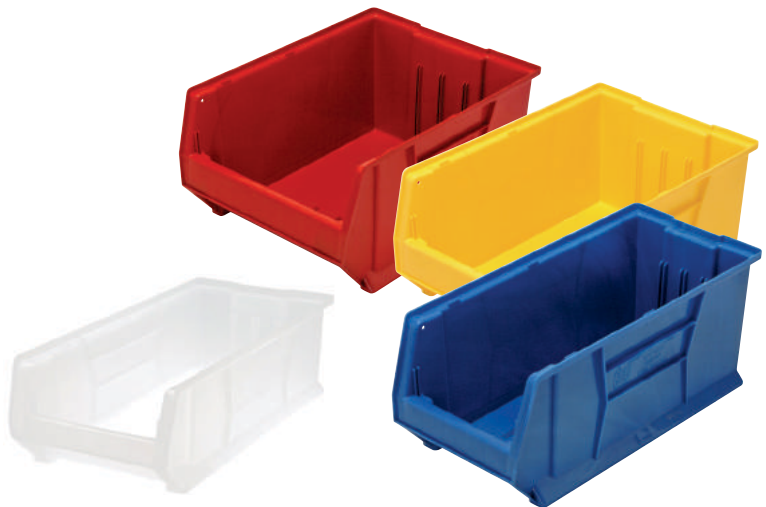

Model No.				Mfg. No.	Outside Dimensions			
Blue	Red	Yellow	Clear		W"	x D"	x H"	
CD545	CD546	CD547	CF525	QUS950	8 1/4	x 23 7/8	x 7	
CD548	CD549	CD550	CF526	QUS951	8 1/4	x 23 7/8	x 9	
CD551	CD552	CD553	CF527	QUS952	11	x 23 7/8	x 7	
CD554	CD555	CD556	CF528	QUS953	11	x 23 7/8	x 10	
CD557	CD558	CD559	CF529	QUS954	16 1/2	x 23 7/8	x 11	
CD560	CD561	CD562	CF530	QUS955	18 1/4	x 23 7/8	x 12	
CF196	CF197	CF198	-	QUS970	8 1/4	x 29 7/8	x 7	
CF199	CF200	CF201	-	QUS973	11	x 29 7/8	x 10	
CF202	CF203	CF204	-	QUS974	16 1/2	x 29 7/8	x 11	
CF205	CF206	CF207	-	QUS975	18 1/4	x 29 7/8	x 12	
CF208	CF209	CF210	-	QUS976	16 1/2	x 29 7/8	x 15	

Divider Model No.	Window Model No.
CD563	CD569
CD564	CD570
CD565	CD571
CD566	CD572
CD567	CD573
CD568	CD574
-	CD569
-	CD572
-	CD573
-	CD574
-	CF211

STACK & NEST TOTES

- Will stack with or without lids for maximum storage and shipping
- Ability to stack and can be turned 180° to nest when empty
- Textured bottoms ensure safe and easy, non-slip grip transit on conveyors
- Injection-molded from high-density polyethylene material
- Will not rust, corrode or bend out of shape
- Are unaffected by chemicals and are waterproof
- Fit on standard 48" x 40" pallets
- Can withstand temperature ranges from -10°F to 250°F
- Ribs under lip prevent jamming when nested
- Handle grips on either side
- Made of FDA compliant materials



Optional lids protect container contents. As pictured, lids can be fastened and locked for added security

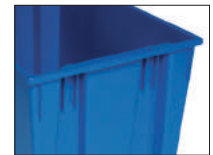

All nine sizes of totes have the ability to use the optional clear label holder. It securely attaches to SNT with or without lid for easy part identification.

CONTAINERS

CONTAINERS													LIDS					
Blue	Model No.		Mfg. No.	Outside Dimensions					Inside Dimensions					Qty /Case	Blue	Model No.		Qty /Case
	Grey	Red		L"	x	W"	x	H"	L"	x	W"	x	H"			Grey	Red	
CC315	CC316	CC317	SNT180	18	x	11	x	6	15 1/4	x	9 3/8	x	5 7/8	6	CC342	CC343	CC344	6
CC318	CC319	CC320	SNT185	18	x	11	x	9	15 1/8	x	9 1/8	x	8 7/8	6	CC342	CC343	CC344	6
CC321	CC322	CC323	SNT190	19 1/2	x	15 1/2	x	10	16	x	13 1/4	x	9 7/8	6	CC345	CC346	CC347	6
CC324	CC325	CC326	SNT195	19 1/2	x	15 1/2	x	13	15 7/8	x	13 3/8	x	12 7/8	6	CC345	CC346	CC347	6
CC327	CC328	CC329	SNT200	19 1/2	x	13 1/2	x	8	16 3/8	x	11 1/2	x	7 7/8	6	CC348	CC349	CC350	6
CC330	CC331	CC332	SNT225	23 1/2	x	19 1/2	x	10	19 3/8	x	16 7/8	x	9 7/8	3	CC351	CC352	CC353	3
CC333	CC334	CC335	SNT230	23 1/2	x	19 1/2	x	13	19 1/2	x	16 7/8	x	12 7/8	3	CC351	CC352	CC353	3
CC336	CC337	CC338	SNT240	23 1/2	x	15 1/2	x	12	19 5/8	x	13	x	11 7/8	3	CC354	CC355	CC356	3
CC339	CC340	CC341	SNT300	29 1/2	x	19 1/2	x	15	25 1/8	x	16 5/8	x	14 7/8	3	CC357	CC358	CC359	3

Model No. CC360

Label holder, accommodates up to 3" x 5". Fits all SNT containers.

QUANTUM NESTING TOTES

- High-density polyethylene
- Rolled top rim for comfortable grip
- Eight 1/4" position drill holes on bottom allow for drainage
- Dimensions: 24 1/2" L x 19" W x 9 1/2" H
- Made of FDA approved materials

Model No. CD244 Grey

Model No. CD434 Blue



COLLAPSIBLE CONTAINERS

- Polypropylene construction
- Collapses to 21" L x 14" W x 2" H for convenient storage
- Open dimensions: 21" L x 14" W x 10 1/2" H
- Reinforced base for added durability
- 16 heavy-duty steel pins built in for increased strength
- Capacity: 160 lbs.

Model No. CF326



STACK-N-NEST CONTAINERS

STACK-N-NEST PLASTIC CONTAINERS

- Polyewton® Stack-N-Nest containers used in general manufacturing, food processing and distribution applications
- Injection-molded from high-impact polyolefins
- Will not rust, rot or corrode, resist damaging effects of oil, most chemical solvents, water and steam
- Stack without lids
- Nest at alternating 180° positions when empty
- Withstands wide temperature variances
- Easily cleaned

Blue & grey bins made of FDA compliant materials



CONTAINERS

Grey	Model No.			Mfg. No.	Outside Dim. Top			Outside Dim. Bottom			Volume cu.ft.	Nesting Ratio	Wt. lbs.	LIDS				
	Red	Blue			L"	x	W"	x	H"	L"				x	W"	Grey	Red	Blue
CA341	CC859	CC868		SN2012-6	20.1	x	13.0	x	6.2	18.5	x	11.5	0.6	2.1:1	2.1	CA334	CC877	CC883
CA344	CC860	CC869		SN2414-8	24.0	x	14.1	x	7.9	21.8	x	11.5	1.1	4:1	3.4	CA337	CC880	CC886
CA342	CC861	CC870		SN2013-12	19.4	x	12.9	x	12.1	17.3	x	10.9	1.3	4:1	3.8	CA335	CC878	CC884
CA343	CC862	CC871		SN2117-12	21.0	x	17.0	x	12.0	18.8	x	15.0	1.8	4:1	5.0	CA336	CC879	CC885
CA346	CC863	CC872		SN2618-10	26.1	x	18.7	x	10.5	24.0	x	15.9	2.1	4:1	5.4	CA339	CC882	CC888
CA348	CC864	CC873		SN3022-6	29.6	x	22.4	x	6.1	28.3	x	21.0	2.1	4:1	4.8	N/A	N/A	N/A
CA347	CC865	CC874		SN2818-10	28.4	x	18.7	x	10.5	26.0	x	15.9	2.3	4:1	5.8	N/A	N/A	N/A
CA345	CC866	CC875		SN2420-13	24.0	x	20.0	x	13.0	21.6	x	17.7	2.7	4:1	6.1	CA338	CC881	CC887
CA349	CC867	CC876		SN3024-15	30.1	x	24.0	x	15.1	27.0	x	21.0	4.7	4.5:1	11.0	N/A	N/A	N/A

STACK-N-NEST PLEXTON CONTAINERS

- Ideal solution for heavy-duty storage, work-in-process and distribution applications
- Can withstand temperatures as low as -60°F and as high as 250°F (continuous)
- Resistant to moisture, chemicals, solvents and most oils
- Capacity: 500 lbs. per container



CONTAINERS

Red	Model No.		Mfg. No.	Outside Dim. Top			Inside Dim. Top			Qty /Case	LIDS			DOLLIES	
	Red	Grey		L"	x	W"	x	H"	L"		x	W"	Red		Grey
CD179	CD193		SN1610-5	17.9	x	10.8	x	5	15.9	x	10.1	10	CD207	CD216	CD225
CD180	CD194		SN1812-6	19.8	x	12.8	x	6	18.1	x	11.9	10	CD208	CD217	CD226
CD181	CD195		SN1812-8	20.6	x	13.0	x	8	18.0	x	12.3	10	CF673	CF672	CD227
CD182	CD196		SN2010-7	24.1	x	11.4	x	6.9	20.0	x	10.7	10	CD210	CD219	CD228
CD183	CD197		SN2010-9	24.1	x	11.4	x	9	20.0	x	10.6	10	CD210	CD219	CD228
CD184	CD198		SN2214-5	24.3	x	14.8	x	5.1	21.7	x	14.0	8	CD211	CD220	CD229
CD185	CD199		SN2214-8	24.3	x	14.8	x	8	21.5	x	13.9	8	CD211	CD220	CD229
CD186	CD200		SN2217-6	25.3	x	18.1	x	6.1	21.4	x	18.1	10	CD212	CD221	CD230
CD187	CD201		SN2217-10	25.3	x	18.1	x	10.1	22.8	x	17.3	5	CD212	CD221	CD230
CD188	CD202		SN2419-4	27.5	x	19.9	x	14.1	23.1	x	18.9	5	CD213	CD222	CD231
CD189	CD203		SN2713-7	29.6	x	13.8	x	7	26.7	x	12.9	10	N/A	N/A	N/A
CD190	CD204		SN2716-11	30.6	x	16.9	x	11.1	26.3	x	15.9	5	CD214	CD223	CD232
CD191	CD205		SN3023-8	34.1	x	24.0	x	8.1	30.1	x	21.6	5	N/A	N/A	N/A
CD192	CD206		SN3919-14	42.5	x	20.1	x	14.1	38.1	x	19.0	5	CD215	CD224	CD233

FDA APPROVED POLY CONTAINERS

BUS/UTILITY BOXES

- Made of durable, commercial grade plastic
- Reinforced handles, bottom and ribs for added strength
- Dimensions: 20" L x 15" W x 5" H
- Capacity: 17.5 L
- Certified to NSF Std. #2 (splash zone)
- USDA Meat & Poultry Equipment Group Listed and assists in complying w/HACCP guidelines



Model No. CD445 Grey
Mfg. No. 3349
Model No. CD446 White
Mfg. No. 3349
Model No. CD662 Grey Cover
Mfg. No. 3648



GENERAL PURPOSE PAILS

- Snap on lids available: Dry seal type or gasket type for liquid handling
- Galvanised steel handles except CB040



ROPAK

Model No.	Description	Dimensions Dia" x W"	Lid Type	Wt. lbs.
CB040	4-L Pail w/Plastic Handle	8 1/4 x 6	-	0.5
CB039	Lid for Pails 4, 5, 6 L w/Static Joint	8 1/2 x 1/2	Gasket	0.2
CB043	11.4-L Pail w/Metal Handle	11 x 9	-	1.1
CB041	Lid for Pails 11.4 L w/o Static Joint	11 3/8 x 5/8	Dry Seal	0.3
CB046	20-L Pail w/Metal Handle	11 7/8 x 15 3/8	-	2.0
CC426	Lid for 20-L pail	12 1/2 x 5/8	Dry Seal	0.4
CB045	Heavy-duty Lid for 20 and 23-L Pails w/Pouring Spout	12 1/8 x 3/4	Gasket	0.6

CYLINDRICAL TANKS

- Easy to clean and heavy-duty cylindrical tanks
- Ideal for mixing and storage of chemicals and food products
- Molded from 100% virgin LLDPE (linear low density polyethylene)
- Can remain full of liquids at room temperature without support
- An economical alternative to stainless steel tanks
- Naturally translucent so that the product level can be viewed at a glance
- Includes a lid
- Accepted for use in Canadian food processing facilities

CF795



CF794



Model No.	Mfg. No.	Capacity Gallons	Inside Diameter"	Depth"	Wall Thickness"	Tank Weight lbs.	Lid Weight lbs.
CF793	1635	25	16	35	3/16	8	1
CF794	2234	45	22.5	34	3/16	17	3
CF795*	3048	125	30	48	1/4	38	-
CF796	4248	240	42	48	1/4	65	11

* Lid not included

CROSS STACK BINS

- Ideal for production, assembly and order picking
- Injection-molded from high-impact polyethylene; will not crack or rust, and easy to clean
- Can be turned 90° to cross stack
- Built-in handle and bottom grooves for easy handling
- Capacity: 100 lbs.
- Made of FDA compliant materials
- Optional clear label holder CC360
- Drill hole pattern on bottom can be opened for drainage purposes



CONTAINERS

LIDS

Model No.			Dimensions			Model No.		
Blue	Grey	White	L"	W"	H	Blue	Grey	White
CD583	CD584	CD585	17 1/4	x 11	x 12	CF016	CD586	CF017
CD247	CD246	CD248	25 1/8	x 16	x 8 1/2	CF018	CD606	CF019

MOBILE INGREDIENT BINS

- Provide storage, protection and easy movement of all your ingredients with a hinged lid
- Smooth inside surface for easy cleaning
- 3" heavy-duty casters (two fixed, two swivel) provide both stability and manoeuvrability
- Made of FDA compliant materials
- Accepted for use in Canadian food processing facilities



Model No.	Capacity		Outside Dimensions			Lid	Wt. lbs.
	Cu. ft.	Imperial Gal.	L" x W" x H"				
NG953	3.36	21	29 x 12.25 x 27	Hinged	20		
NG954	4.4	28	29 x 15 x 27	Hinged	25		
NG955	6	45	33 x 19 x 29	Sliding	35		

PROSAVE™ MOBILE INGREDIENT BINS WITH 32-OZ. SCOOP

- Seamless construction, rounded corners and smooth walls make these bins easy to clean and bacteria free
- Clear, see-through lid with slide-back feature ideal for placing bin under counters
- Includes a scoop hook allowing scoop to be stored in bin and out of product, an ideal solution where cross contamination is a concern, and a 32-oz scoop
- USDA meat and poultry listed
- NSF Certified
- Made of FDA compliant materials



Model No.	Description	Capacity Cu. ft.	Dimensions		
			L" x W" x H"		
CA616	Slant front	2 3/4	29.25 x 13.13 x 28		
CA617	Slant front	3 1/2	29.50 x 15.50 x 28		
CA618	Slant front	4 1/8	29.75 x 18 x 28		
CC425	Flat front	3 3/4	22 x 23 x 23		

STAKPAK & DIVIDER BOX CONTAINERS

STAKPAK PLUS 4845 SYSTEM CONTAINERS

- Stack-only, injection molded, straight-wall modular containers
- High-density polyethylene (HDPE)
- Reinforced external ribbing adds maximum stacking strength

- Smooth, straight interior walls provide maximum space utilisation and easy cleaning
- Modular design optimizes cube on standard 45" x 48" pallet, allows for mixing and matching of various sizes

- Ergonomically designed handles for comfort and safety
- Containers hold up under temperatures from -10°F to 120°F
- Optional cardholders available

ORBIS

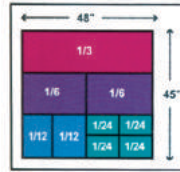

48" x 15" (1/3)
24" x 15" (1/6)
12" x 15" (1/12)
12" x 7" (1/24)

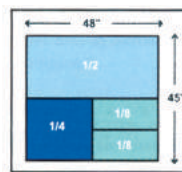

48" x 22" (1/2)
24" x 15" (1/4)
24" x 11" (1/8)

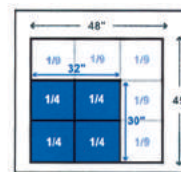

16" x 15" (1/4)
on AIAG 30" x 32"
15" x 15" (1/9)
on AIAG 45" x 48"

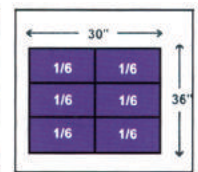

12" x 15" (1/6)

Model No.			Pallet Modularity (AIAG)		Outside Dimensions		Total Container Height"	Product Clearance"	Volume cu.ft.	48' Trailer Capacity (containers)	Wt. lbs.	Lids Model No.			Cardholder Model No.
Medium Green	Grey	Royal Blue	30" x 36"	45" x 48"	Top L" x W"	Bottom L" x W"		*				Medium Green	Grey	Royal Blue	
STAKPAK CONTAINERS															
CA498	CA499	CC112	1/12	1/24	12.0 x 7.4	12.0 x 7.4	5.0	4.5	0.1	8640	1.1	N/A	CA488	N/A	CA448
CA500	CA501	CC113	1/6	1/12	12.0 x 15.0	12.0 x 15.0	5.0	4.4	0.3	4320	1.6	CA489	CA490	CC121	CA448
CA502	CA503	CC114	1/6	1/12	12.0 x 15.0	12.0 x 15.0	7.5	6.8	0.5	3456	2.2	CA489	CA490	CC121	CA449
CA504	CC174	CC115	1/6	1/12	12.0 x 15.0	12.0 x 15.0	9.5	8.8	0.6	2304	2.5	CA489	CA490	CC121	CA449
CA507	CA508	CC116	-	1/6	24.0 x 15.0	24.0 x 15.0	5.0	4.5	0.7	2592	3.0	CA491	CA492	CC122	CA448
CA509	CA510	CC117	-	1/6	24.0 x 15.0	24.0 x 15.0	7.5	6.8	1.1	1728	3.6	CA491	CA492	CC122	CA449
CA511	CA512	CC118	-	1/6	24.0 x 15.0	24.0 x 15.0	9.5	8.8	1.4	1296	4.4	CA491	CA492	CC122	CA449
CA505	CA506	CC119	-	1/6	24.0 x 15.0	24.0 x 15.0	14.5	13.8	2.2	864	5.7	CA491	CA492	CC122	CA449
STAKPAK LIDS															
-	CA488	-	-	-	12.0 x 7.4						0.4	CARDHOLDERS			
CA489	CA490	CC121	-	-	12.0 x 15.0						0.6	Model No.	Dimensions L" x W"		
CA491	CA492	CC122	-	-	24.0 x 15.0						2.1	CA448	8.5 x 4.0		
												CA449	8.5 x 4.6		

* When containers are stacked on top of each other approximately 1/2" is lost to nesting.

DIVIDER BOX® CONTAINERS

- Divider Box® (DC) series containers are injection-molded HDPE
- DG series are injection-molded from high-density FDA approved polyethylene which resists most solvents and chemicals
- Large, flat areas on all four sides for content identification
- Comfort grip handle
- Stacking rims and multi-ribbed external sides provide high impact strength
- All containers can be divided into compartments by length and/or width
- Molded-in stacking ridge assures containers will stack securely with or without covers
- One set of cardholder snaps and security tie holes on two ends included on DC models only
- Full range of optional accessories available including hook and loop card holders for DG models and snap-on card holders for DC models, vertical dividers and covers
- Optional dolly (CF400) allows for easy transport



CARD HOLDERS

Model No.			Mfg. No.	Dimensions			Volume cu.ft.	Wt. lbs.	Short Dividers		Long Dividers		Clear Lids Model No.	Snap-On or Hook & Loop Model No.
Grey	Red	Light Blue		L" x W" x H"	L" x W" x H"	L" x W" x H"			Model No.	No. of Slots	Model No.	No. of Slots		
CA562	CC833	CC846	DC1025	10.8 x 8.3 x 2.5	9.2 x 6.6 x 2.5	0.07	0.5	CA568	7	CA571	5	CA556**	CC314	
CC641	CC934	CC946	DG91035	10.9 x 8.3 x 3.5	9.2 x 6.6 x 3.0	0.10	0.9	CC659	7	CC650	5	CD437*	CF351	
CC642	CC935	CC947	DG91050	10.9 x 8.3 x 5.0	9.2 x 6.6 x 4.5	0.19	1.2	CC660	7	CC651	5	CD437*	CF352	
CA565	CC836	CC849	DC2025	16.5 x 10.9 x 2.5	14.8 x 9.2 x 2.5	0.16	0.9	CA571	11	CA577	7	CA559/CA561**	CC314	
CC643	CC936	CC948	DG92035	16.5 x 10.9 x 3.5	14.9 x 9.3 x 3.0	0.24	1.42	CC661	11	CC652	7	CD438*	CF351	
CC644	CC937	CC949	DG92060	16.5 x 10.9 x 6.0	14.9 x 9.3 x 5.5	0.44	1.88	CC662	11	CC653	7	CD438*	CF352	
CA566	CC840	CC853	DC2070	16.5 x 10.9 x 7.0	15.0 x 9.3 x 7.0	0.51	1.7	CA575	11	CA581	7	CA559/CA561**	CA446/CC314	
CC645	CC938	CC950	DG92080	16.5 x 10.9 x 8.0	14.9 x 9.3 x 7.5	0.60	2.5	CC663	11	CC654	7	CD438*	CF353	
CC646	CC939	CC951	DG93030	22.5 x 17.5 x 3.0	20.6 x 15.6 x 2.5	0.44	2.5	CC664	15	CC655	11	CD439*	CF351	
CA567	CC842	CC855	DC3050	22.4 x 17.4 x 5.0	20.3 x 15.3 x 5.0	0.79	2.6	CA584	15	CA588	11	CA560/CD456**	CA446/CC314	
CC647	CC940	CC952	DG93060	22.5 x 17.5 x 6.0	20.6 x 15.6 x 5.5	0.97	4	CC665	15	CC656	11	CD439*	CF352	
CC648	CC941	CC953	DG93080	22.5 x 17.5 x 8.0	20.6 x 15.6 x 7.5	1.32	4.67	CC666	15	CC657	11	CD439*	CF353	
CC649	CC942	CC954	DG93120	22.5 x 17.5 x 12.0	20.6 x 15.6 x 11.5	2.03	5.67	CC667	15	CC658	11	CD439*	CF353	

* Grey, red and blue covers available. ** Grey and blue covers available.

DISTRIBUTION CONTAINERS

These reusable, returnable, attached-lid containers are ideal for use in wholesale product distribution and as picking containers. Hinged covers with tight interlocking fit provide maximum security and protection. Containers stack with lids closed and nest with lids open for optimum use of space in trucks, trailers or on pallets. Pebble grain bottom surface provides extra traction on conveyors. Load capacity per container is a maximum of 70-75 lbs. Bottom container will support 250 to 300 lbs. when stacked. (Please inquire for exact load capacities). Flipak™ containers are available in polyethylene plastic (PE) and polypropylene plastic (PP).

FLIPAK® POLYETHYLENE PLASTIC (PE) DISTRIBUTION CONTAINERS

- High-density polyethylene (HDPE) construction offers maximum product protection from moisture, impact and chemicals



ORBIS

Grey	Model No.		Outside Dimensions				Volume cu. ft.	Nesting Ratio	Wt. lbs.
	Red	Blue	Top		Bottom				
	L" x W" x H"	L" x W" x H"	L" x W"	L" x W"					
LESS THAN 2.0 CU.FT.									
CA452	-	CF265	11.8 x 9.8 x 7.7	9.3 x 7.0	0.3	2.8:1	2.1		
CA453	-	CF266	15.2 x 10.9 x 9.7	12.8 x 7.8	0.6	4.0:1	3.0		
CA454	-	-	21.8 x 15.1 x 5.5	18.9 x 13.7	0.7	3.6:1	4.8		
CA455	-	CF268	19.7 x 11.8 x 7.3	16.9 x 9.3	0.7	3.0:1	3.4		
CA456	-	-	20.6 x 13.5 x 6.5	18.2 x 11.7	0.8	2.1:1	5.2		
CA457	-	-	20.6 x 13.2 x 11.6	17.7 x 11.0	1.4	4.4:1	5.9		
CF559	CF556	CF557	21.9 x 15.2 x 9.3	19.1 x 13.3	1.3	4.4:1	5.0		
CA461	-	CF273	22.3 x 13.0 x 12.8	19.1 x 10.9	1.6	3.8:1	6.2		
CA462	CA463	CF274	21.8 x 15.2 x 12.9	18.6 x 12.9	1.8	4.0:1	6.5		
CA464	-	-	23.5 x 15.7 x 13.0	19.9 x 13.0	1.9	4.5:1	6.9		
2.0 CU.FT. & GREATER									
CF504*	CF503*	CF506*	26.9 x 16.9 x 12.1	24.4 x 14.7	2.4	4.2:1	8.2		
CA468	CA469	CF277	23.9 x 19.6 x 12.6	21.1 x 17.1	2.7	5.3:1	8.4		
CA471	-	-	39.0 x 14.0 x 13.0	36.3 x 11.3	3.3	4.9:1	10.4		
CA475	-	-	30.0 x 22.0 x 20.5	27.4 x 19.4	6.1	4.0:1	17.0		

*Dollies available for these sizes

FLIPAK® DOLLY

- Inside Dimensions: 24.4" L x 14.6" W
- Outside Dimensions: 26.9" L x 16.9" W
- Height Without Casters: 7"
- Allows for easy and efficient transport of multiple for Flipak® containers
- High corner supports hold totes in place
- Dollies securely stack together
- Easily cleanable
- All-plastic construction is durable, increases service life and reduces product damage
- Rugged rubber casters withstand varying ground surfaces
- Standard 3" casters included
- Compatible with CF503-CF506

Model No. CF936

FLIPAK® CLEAR POLYPROPYLENE PLASTIC (PP) DISTRIBUTION CONTAINERS

- Offer all the same benefits as the polyethylene containers, plus provide easy content identification
- Polypropylene (PP) is the same family as polyethylene
- Polypropylene's advantages over polyethylene include its greater stiffness and elevated use
- Temperature range: 30°F - 150°F



ORBIS

Model No.	Outside Dimensions			Volume cu. ft.	Nesting Ratio	Wt. lbs.
	L" x W" x H"	Bottom				
	L" x W" x H"	L" x W"	L" x W"			
LESS THAN 2.0 CU.FT.						
CC128	11.8 x 9.8 x 7.7	9.3 x 7.0	0.3	2.8:1	2.1	
CC129	15.2 x 10.9 x 9.7	12.8 x 7.8	0.6	4.0:1	3.0	
CC130	19.7 x 11.8 x 7.3	16.9 x 9.3	0.7	3.0:1	3.4	
CF558	21.9 x 15.2 x 9.8	19.1 x 13.3	1.4	4.4:1	5.0	
CC132	21.8 x 15.2 x 12.9	18.6 x 12.9	1.8	4.0:1	6.2	
2.0 CU.FT. & GREATER						
CF505*	26.9 x 16.9 x 12.1	24.4 x 14.7	2.3	5.3:1	7.8	

*Dollies available for these sizes



ORBIS

FLIP TOP ECONOMY CONTAINERS

- Stacks when lid is closed
- Nests when empty
- Recessed carry handles
- Dimensions: 21 1/2" L x 15" W x 12 1/2" H
- Capacity: 45 litres
- Weight: 5 lbs.

TRANSLUCENT

Model No. CD383 Black Top
Model No. CF555 Red Top

GREY

Model No. CD459



IP
INTEGRATED PLASTICS

BINS & SUPPORT RACKS

METAL BIN SUPPORT RACKS

- Louvered bin panels can be wall-mounted, attached to back of shelving, mounted on benches, carts, inside cabinets, fastened to slotted angle components or used for service truck interiors
- Bins are easily removed, refilled and replaced
- Each heavy-duty panel is 16-gauge cold-rolled steel
- Slotted holes 3/4" L x 3/8" W at 6" centres simplify installation
- Kleiton grey powder coated
- Installation note:** Panels must be securely fastened to materials of adequate load bearing strength



CF412

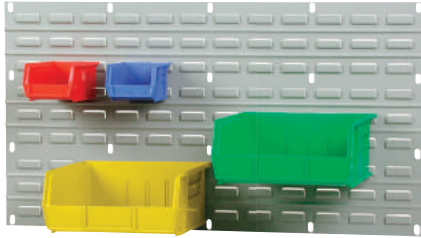

BIN QUANTITY TABLE

Quantity of identical plastic bins that fit CF412 Panel

Bins not included

Panel Height 35 3/4" Wide	Model No.						
	Bin CB093	Bin CB096	Bin CB099	Bin CB102	Bin CB105	Bin CB108	Bin CB111
1 Panel = 19" H	32	32	18	9	8	8	4
2 Panels = 37" H	72	72	36	18	18	16	8
3 Panels = 55" H	104	104	54	27	28	28	14
4 Panels = 73" H	144	144	72	36	36	36	18

For CF411 Panel, use 1/2 of bin quantities shown above

Model No.	Panel Dimensions		Wt. lbs.
	W" x H"	H"	
CF411	18 x 19	6	6
CF412	36 x 19	12	12



BENCH LOUVERED RACKS

- All-welded louvered bench rack
- Provides tool and storage for assembly or repair operations when combined with plastic parts bin
- Durable Kleiton blue enamel finish

36" FREE STANDING RACKS

- Free standing unit made of 1" square tube frame
- May be placed on any flat surface near a worksite without the need for bolts or fasteners

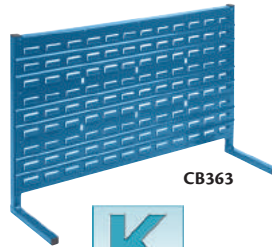

CB363



72" BOLT-ON RACKS

- Constructed of 1 1/4" square tube frame
- Designed to be permanently installed on a 72" wide workbench

Model No.	Rack Type	Dimensions			Wt. lbs.
		W" x D" x H"	D" x H"	H"	
CB363	Free Standing	36 x 10 x 22			22
CB364	Bolt-On	72 x 15 x 40			95

BINS CARTS

- All-welded bin cart
- Work surface made of 14-gauge steel
- Includes:** 20 bins of various size, bolted-on 5" non-marking casters and two louvered panels
- Capacity: 1000 lbs.
- Durable Kleiton blue enamel finish

BINS SUPPLIED

Bin Qty	Bin Dimensions		
	W" x D" x H"	D" x H"	H"
16	8 1/4 x 14 3/4 x 7		
4	16 1/2 x 14 3/4 x 7		



CB367

Model No.	Description	Dimensions			Wt. lbs.
		W" x D" x H"	D" x H"	H"	
CB365	Cart Only	24 x 38 1/2 x 36 1/2			95

CART/BIN COMBINATION

Blue	Red	Yellow	Green	Bin Qty	Wt. lbs.
CB366	CB367	CB368	CB689	20	133

STATIONARY BIN RACKS

- Designed to be permanently installed to the floor
- All-welded stationary bin racks
- Constructed of 1 1/4" square tube frame
- Choose from either single or double-sided racks to meet your storage needs
- Durable Kleiton blue enamel finish
- Includes 28 or 56 bins
- 8 1/4" W x 14 3/4" D x 7" H
- Shipped all-welded



Model No.	Description	Rack Type	Dimensions			Wt. lbs.
			W" x D" x H"	D" x H"	H"	
CB373	Rack Only	Single	36 x 12 x 61			60
CB653	Rack Only	Double	36 x 24 x 61			100

RACK/BIN COMBINATION

Blue	Red	Yellow	Green	Rack Type	Bin Qty	Capacity lbs.
CB654	CB655	CB656	CB685	Single	28	1680
CB370	CB371	CB372	CB687	Double	56	3360

ACCESSORIES

Model No.	Description
CC165	Round Hook, 6"
CC166	Round Hook, 12"
CC167	Square Hook, 6"
CC168	Square Hook, 12"



MOBILE BIN RACKS

- Ideal for transportation of small parts
- All-welded mobile bin rack
- Single** includes 36 bins
- 5 1/2" W x 10 7/8" D x 5" H, 3" casters and two louvered panels
- Double cart** includes 96 bins of various sizes, bolted on 5" non-marking casters and six louvered panels
- Capacity: 800 lbs. single sided and 1000 lbs. double sided
- Durable Kleiton blue enamel finish



CB090
Double-sided



BINS SUPPLIED

Bin Qty	Bin Dimensions		
	W" x D" x H"	D" x H"	H"
36	5 1/2 x 10 7/8 x 5		

Model No.	Description	Rack Type	Dimensions			Wt. lbs.
			W" x D" x H"	D" x H"	H"	
CB359	Rack only	Single	36 x 16 x 46			60
CB649	Rack only	Double	36 x 24 x 63			120

RACK/BIN COMBINATION

Blue	Red	Yellow	Green	Rack Type	Bin Qty	Wt. lbs.
CB650	CB651	CB652	CB681	Single	36	83
CB089	CB090	CB091	CB683	Double	96	187



CORRUGATED PARTS BINS & DIVIDERS

- Economical standard duty bins constructed of durable corrugated fibreboard
- Ideal for storing any loose small parts
- Assembled easily without staples or tape, just fold
- Bins are designed to hang from the shelf for hands-free access
- Bin dividers not included
- Qty per case: 100
- Shipped knocked down

Standard Corrugated Bins & Dividers



Removable dividers ease handling

12" DEEP PARTS BINS

Model No.	Ctn. Wt. lbs.	Model No.	Ctn. Wt. lbs.	Dimensions W" x H"
CB063	17	CB056	22	2 x 4 1/2
CB064	19	CB057	27	3 x 4 1/2
CB065	20	CB058	30	4 x 4 1/2
CB066	25	CB059	38	6 x 4 1/2
CB067	31	CB060	45	8 x 4 1/2
CB068	36	N/A	-	9 x 4 1/2
CB052	38	CB054	50	10 x 4 1/2
CB053	44	CB055	57	12 x 4 1/2

18" DEEP PARTS BINS

3 5/8" DEEP REMOVABLE DIVIDERS

Model No.	Dimensions W" x H"	Ctn. Wt. lbs.	Model No.	Dimensions W" x H"	Ctn. Wt. lbs.
CB071	1 3/4 x 4 1/8	7	CB075	7 3/4 x 4 1/8	22
CB072	2 3/4 x 4 1/8	9	CB069	9 3/4 x 4 1/8	27
CB073	3 3/4 x 4 1/8	10	CB070	11 3/4 x 4 1/8	31
CB074	5 3/4 x 4 1/8	14			



SINGLE-SIDED PICK-RACKS

- Units are free standing, but may be bolted to bench top, floor or wall
- 61" high floor model comes with 48-4" plastic storage bins and 10-6" plastic storage bins or 48-4" corrugated bins and 8-8" corrugated bins
- 21 1/2" high bench model comes with 16-4" plastic storage bins, and 5-6" plastic storage bins or 16-4" corrugated storage bins and 4-8" corrugated storage bins
- Order complete with plastic shelf bins, fibreboard bins or rack only
- Grey enamel finish
- Shipped knocked down

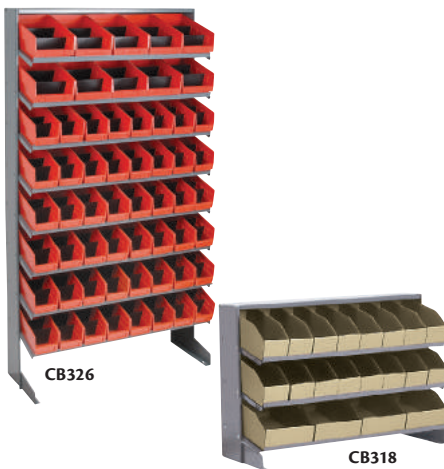

DOUBLE-SIDED MOBILE PICK-RACKS

- 22-gauge steel rack components mounted on a 26" x 36" dolly
- 3" casters
- Each rack accommodates 96-4" wide storage bins and 20-6" wide bins
- Order complete with plastic shelf bins, fibreboard bins or rack only
- Grey enamel finish
- Shipped knocked down

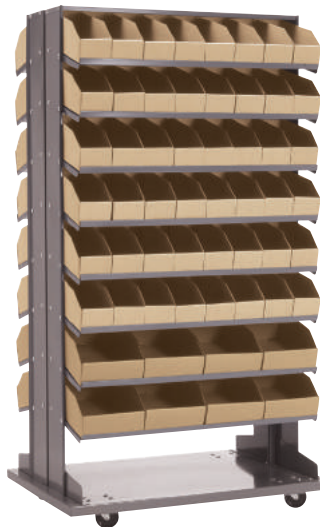

PARTS STORAGE SHELVING UNITS

- Provides a versatile heavy-duty storage facility for parts storage bins
- 76" high unit comes with 96-4" bins
- 40" high unit comes with 48-4" bins
- Available with plastic shelf bins, fibreboard bins or shelving only
- Grey enamel finish
- Shipped knocked down



Model No.	Dimensions W" x D" x H"	Bin Type	Wt. lbs.		
CB318	32 7/8 x 12 1/8 x 21 1/2	Corrugated	22		
CB377	32 7/8 x 12 1/8 x 21 1/2	Rack Only	17		
CB323	33 1/2 x 12 1/4 x 61	Corrugated	57		
CB378	33 1/2 x 12 1/4 x 61	Rack Only	45		
Blue	Red	Yellow			
CB320	CB321	CB322	21 1/2	Plastic	25
CB325	CB326	CB327	61	Plastic	65

Model No.	Dimensions W" x D" x H"	Bin Type	Wt. lbs.		
CB328	33 1/2 x 12 1/4 x 65	Corrugated	139		
CB337	33 1/2 x 12 1/4 x 65	Rack Only	115		
Blue	Red	Yellow			
CB330	CB331	CB332	65	Plastic	155

Model No.	Dimensions W" x D" x H"	Bin Type	Wt. lbs.		
CF048	36 x 12 x 40	Corrugated	90		
RK203	36 x 12 x 40	Shelving Only	80		
CF184	36 x 12 x 76	Corrugated	163		
RK241	36 x 12 x 76	Shelving Only	144		
Blue	Red	Yellow			
CF049	CF050	CF051	40	Plastic	96
CF053	CF054	CF055	76	Plastic	176

BINS/STORAGE CABINETS

DEEP DOOR COMBINATION CABINETS

- All-welded heavy-duty 16-gauge, combination bin/shelf cabinet
- 4" deep hinged doors
- Unique padlock hasp helps prevent access with bolt cutters
- Powder coated Kleton grey finish
- Padlock sold separately

A. 84 BIN CABINETS

- Four reinforced 16-gauge main adjustable shelves with 500-lb. capacity per shelf
- Incorporates louvered bin hanging panels welded into the cabinets doors

CABINET ONLY

Model No.	Description	Dimensions			Wt. lbs.
		W"	x D"	x H"	
CB442	Cabinet Only	38	x 24	x 72	324
FB025	Extra Shelf	38	x 21 1/4	x 1	18

CABINET WITH BINS

Blue	Model No.			Description	Wt. lbs.
	Red	Yellow	Green		
CB446	CB477	CB448	CB693	Cabinet and Plastic Bins	341

BINS SUPPLIED

Bin Qty	W"	Bin Dimensions			Capacity lbs.
		x D"	x H"		
84	4 1/8	x 5 3/8	x 3	10	

B. 96 BIN CABINETS

- Two reinforced 16-gauge main adjustable shelves with 500-lb. capacity per shelf
- Incorporates louvered bin hanging panels welded to the cabinet's back and doors

CABINET ONLY

Model No.	Description	Dimensions			Wt. lbs.
		W"	x D"	x H"	
FH820	Cabinet Only	38	x 24	x 72	316
FB025	Extra Shelf	38	x 21 1/4	x 1	18

CABINET WITH BINS

Blue	Model No.			Description	Wt. lbs.
	Red	Yellow	Green		
CF371	CF372	CF373	CF374	Cabinet and Plastic Bins	359

BINS SUPPLIED

Bin Qty	W"	Bin Dimensions			Capacity lbs.
		x D"	x H"		
84	4 1/8	x 5 3/8	x 3	10	
12	5 1/2	x 10 7/8	x 5	30	

C. 98 BIN CABINETS

- Two reinforced 16-gauge main adjustable shelves with 500-lb. capacity per shelf
- Incorporates louvered bin hanging panels welded to the cabinet's back and doors

CABINET ONLY

Model No.	Description	Dimensions			Wt. lbs.
		W"	x D"	x H"	
FH820	Cabinet Only	38	x 24	x 72	316
FB025	Extra Shelf	38	x 21 1/4	x 1	18

CABINET WITH BINS

Blue	Model No.			Description	Wt. lbs.
	Red	Yellow	Green		
CF355	CF356	CF354	CF357	Cabinet and Plastic Bins	385

BINS SUPPLIED

Bin Qty	W"	Bin Dimensions			Capacity lbs.
		x D"	x H"		
48	4 1/8	x 5 3/8	x 3	10	
36	4 1/8	x 7 3/8	x 3	10	
8	8 1/4	x 14 3/4	x 7	60	
6	16 1/2	x 14 3/4	x 7	75	

KLETON

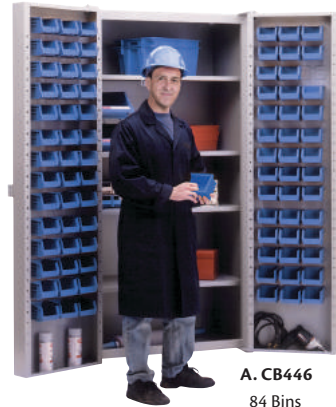

A. CB446
84 Bins



B. CF373
96 Bins



C. CF354
98 Bins



D. CB445
118 Bins

D. 118 BIN CABINETS

- Incorporates louvered bin hanging panels welded to the cabinet's back and doors

CABINET ONLY

Model No.	Description	Dimensions			Wt. lbs.
		W"	x D"	x H"	
CB441	Cabinet Only w/o Shelves	38	x 24	x 72	316

CABINET WITH BINS

Blue	Model No.			Description	Wt. lbs.
	Red	Yellow	Green		
CB443	CB444	CB445	CB691	Cabinet and Plastic Bins	385

BINS SUPPLIED

Bin Qty	W"	Bin Dimensions			Capacity lbs.
		x D"	x H"		
42	4 1/8	x 5 3/8	x 3	10	
42	4 1/8	x 7 3/8	x 3	10	
18	5 1/2	x 10 7/8	x 5	30	
12	8 1/4	x 14 3/4	x 7	60	
4	16 1/2	x 14 3/4	x 7	75	



HEAVY-DUTY PARTS CABINETS

- New design allows 98% use of drawer space to store larger tools or materials
- Housed in an all-welded 22-gauge galvanized steel cabinet
- I.D. card with clear plastic shield and divider included with every drawer
- Steel tabs and drawer stoppers allow for full extension without risk of spilling
- Cabinet has either polystyrene or heavy-duty ABS beige drawers
- Grey enamel finish

CA891



CF283



CC453

CA889



CD440



CA890



CF289



CF293



Model No.	No. of Drawers	Drawer Description	Drawer Dimensions			Cabinet Dimensions			Wt. lbs.				
			W"	x	D"	x	H"	W"		x	D"	x	H"
CF311	18	Polystyrene	3.5	x	8.6	x	2.2	13.9	x	8.7	x	16.3	19
CF312	20	Polystyrene	3.5	x	8.6	x	2.2	18.3	x	8.7	x	13.8	21
CF314	40	Polystyrene	3.5	x	8.6	x	2.2	18.3	x	8.7	x	25.3	40
CF313	25	Polystyrene	3.5	x	8.6	x	2.2	23.1	x	8.7	x	13.8	27
CF315	75	Polystyrene	3.5	x	8.6	x	2.2	23.1	x	8.7	x	36.9	66
CF305	16	Polystyrene	3.5	x	8.6	x	2.7	18.3	x	8.7	x	13.8	21
CF304	15	Polystyrene	3.5	x	8.6	x	2.7	13.9	x	8.7	x	16.3	22
CF306	20	Polystyrene	3.5	x	8.6	x	2.7	23.1	x	8.7	x	13.8	27
CC453	32	Polystyrene	3.5	x	8.6	x	2.7	18.1	x	8.7	x	25.6	31
CC454	60	Polystyrene	3.5	x	8.6	x	2.7	22.6	x	8.7	x	36.9	68
CF298	16	ABS	4.7	x	8.6	x	2.7	23.1	x	8.7	x	13.8	24
CA891	24	ABS	4.7	x	8.6	x	2.7	17.3	x	8.7	x	25.6	33
CA892	48	ABS	4.7	x	8.6	x	2.7	22.6	x	8.7	x	36.9	58
CD440*	48	ABS	4.7	x	8.6	x	2.7	22.6	x	10.8	x	36.9	66.8
CA889	30	ABS	5.9	x	9.8	x	3.3	21.3	x	10.4	x	36.9	58
CF289	24	Polystyrene	5.9	x	9.8	x	1.6	14.3	x	10.4	x	22.5	32
CA890	60	Polystyrene	5.9	x	9.8	x	1.6	21.3	x	10.4	x	36.9	60
CF293	18	Polystyrene	5.9	x	9.8	x	1.6	21.3	x	10.4	x	12.2	25
CF283	12	ABS	6.4	x	11.3	x	2.7	23	x	11.4	x	13.8	28
CF284	24	ABS	6.4	x	11.3	x	2.7	23	x	11.4	x	25.2	47
CF285	36	ABS	6.4	x	11.3	x	2.7	23	x	11.4	x	36.9	60

* Comes with locking doors

HEAVY-DUTY INDUSTRIAL CAROUSEL DRAWER CABINETS

- Create your customized carousel cabinet
- Each level accommodates four parts cabinets with same height
- For a multiple tier cabinet (maximum three tiers), you require add-on-shelves and threaded rods as per the following:
One add-on-shelf **CF402** for each level of cabinets
14" rod required for each level of **CF312** or **CF305** cabinets
25" rod required for each level of **CC453** or **CF314** cabinets
- Rotational base allows for 800-lb. capacity
- All-welded 11-gauge steel base
- Durable Kleton grey enamel finish

Model No.	Description	Dimensions				Wt. lbs.	
		W"	x	D"	x		H"
3 TIER CABINETS KITS							
CF405	192 Drawers	27	x	27	x	48	392
CF406	240 Drawers	27	x	27	x	48	407
CF407	384 Drawers	27	x	27	x	80	497
CF408	480 Drawers	27	x	27	x	80	600
COMPONENTS							
CF401	Base and Top Cover	27 1/2	x	27 1/2	x	4	80
CF402	Add-on Shelf	27 1/2	x	27 1/2	x	1	18
CF403	Threaded Rod - 14"	3/8	x	-	x	14	1
CF404	Threaded Rod - 25"	3/8	x	-	x	25	1.5
CF305	Parts Cabinet - 16 Drawers	18 5/16	x	8 11/16	x	14	21
CF312	Parts Cabinet - 20 Drawers	18 5/16	x	8 11/16	x	14	21
CC453	Parts Cabinet - 32 Drawers	18 5/16	x	8 11/16	x	25	31
CF314	Parts Cabinet - 40 Drawers	18 5/16	x	8 11/16	x	25	40



CF408 (Kit)



INCLUDES:

- 12 - CF314 - Cabinet - 40 drawers
- 1 - CF401 - Base and Top Cover
- 2 - CF404 - Threaded Rod 25"
- 2 - CF402 - Add-on Shelf

PARTS CABINETS

CAROUSEL DRAWER CABINETS

- Designed to utilize open and often unused areas such as corners
- Optional turntable can be used to create a rotary carousel unit providing convenience for accessing small parts storage
- All-welded cabinets include clear drawers, dividers and I.D. labels
- Cabinet overall dimension: 12" W x 5 3/4" D x 22" H
- Blue enamel finish
- Turntable **CA912** may be set up with up to three levels of four cabinets per level

Model No.	No. of Drawers	Drawer Model No.	Drawer Dimensions				Wt. lbs.
			W"	x	D"	x H"	
CA870	60	CD441	2	x	5 5/16	x 1 3/8	10.7
CA869	48	CD442	2 1/2	x	5 5/16	x 1 3/8	10.7
CA868	30	24 x CD442	2 1/2	x	5 5/16	x 1 3/8	10.7
		4 x CD443	5 5/16	x	5 5/16	x 2 1/4	-
		2 x CD444	11	x	5 5/16	x 2 1/4	-
CA867	16	CD443	5 5/16	x	5 5/16	x 2 1/4	10.3
CA912	-		3 Tier Turntable Unit Only				40.0

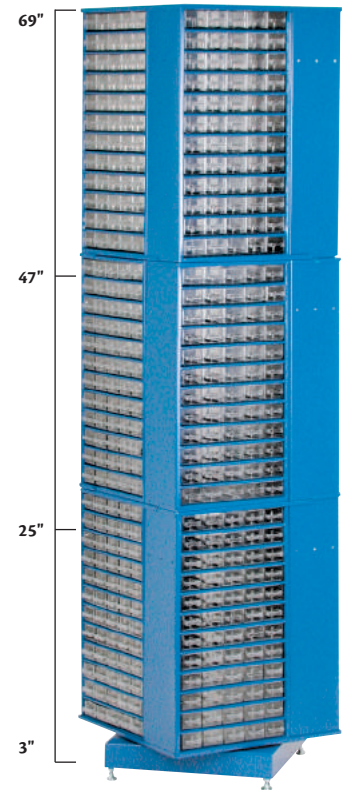
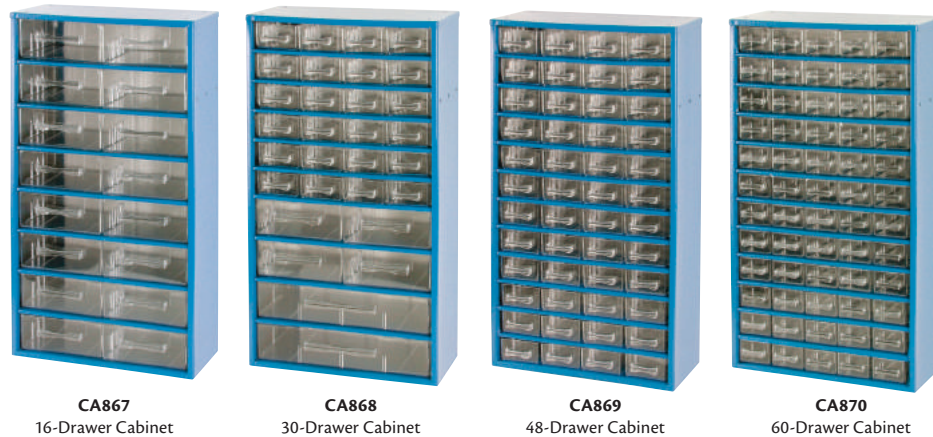

CA912 - Turntable Base
Turntable unit shown with 12 CA870 cabinets (sold separately)

ADD-A-DRAWER®

- Grey plastic drawer modules with clear windows simply slide and lock onto each other
- Can be stacked both horizontally and vertically
- Allows you to create a customized drawer cabinet
- Add on one or more units as more storage capacity is required
- Dividers and labels included



CA841 Shown with two units

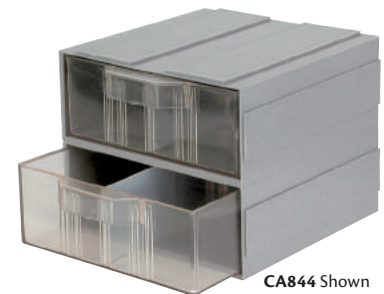

CA844 Shown with two units



CA842 Shown with two units

Customize your drawer cabinet!

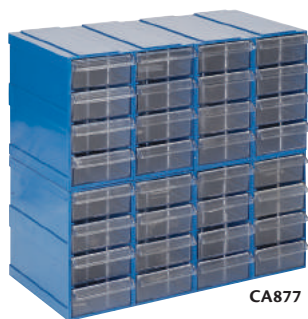

CA877

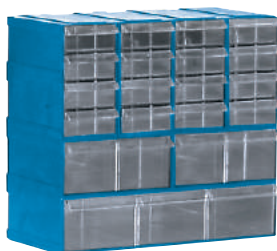

CA855



CD234

Model No.	No. of Drawers	Dimensions				Colour	Wt. lbs.
		W"	x	D"	x H"		
DRAWER MODULES							
CA840	2	5	x	5	x 2	Grey	0.88
CA841	1	2 1/2	x	5	x 2	Grey	0.20
CA842	1	4 1/2	x	10	x 2 1/2	Grey	1.00
CA844	1	5	x	5	x 2	Grey	0.20
CA843	4	3	x	6	x 5 3/4	Blue	1.0
CA845	2	6	x	6	x 3	Blue	1.0
CA846	1	6	x	6	x 3	Blue	1.0
CA847	1	12	x	6	x 3	Blue	1.6
CABINET KITS							
CD234	4	4 1/2	x	10 1/2	x 10	Grey	4
CD235	42	15	x	5	x 16	Grey	15.5
CA877	32	12	x	6	x 10 1/2	Blue	8.0
CA874	27	12	x	6	x 17 3/4	Blue	11.6
CA855	19	12	x	6	x 11 3/4	Blue	7.6

WORKBENCH SMALL PARTS CABINETS

- Ideal for storing small parts right on your workbench
- New design allows for 98% use of drawer space
- I.D. cards and dividers included with every drawer
- Heavy-duty ABS beige drawers
- 30 drawers, dimensions: 6.5" W x 14.8" D x 4.1" H
- Cabinet: 34.6" W x 15.7" D x 34.6" H
- Housed in an all-welded galvanized steel container finished in a grey enamel paint
- Weight: 119 lbs.

Model No. CF323



KLETON



CF318



CF319

KPC-700 PARTS CABINETS

- Drawer size: 4.7" W x 8.6" D x 2.2" H
- Clear polystyrene drawers

KLETON

Model No.	No. of Drawers	Dimensions			Wt. lbs.
		W"	D"	H"	
CF318	20	23.1	8.7	13.6	25
CF319	30	17.5	8.7	25.3	40
CF320	60	23.1	8.7	36.9	71

HEAVY-DUTY DRAWER CABINETS

- Heavy-duty parts cabinets feature break resistant high impact clear plastic "scoop" drawers for easy removal of small parts, with two adjustable compartment dividers
- Drawers dimensions: 2 7/8" W x 5 1/2" D x 1 7/8" H
- Welded steel cabinets are finished in grey powder coat

DURHAM MFG
Est. 1922

Model No.	No. of Drawers	Cabinet Dimensions			Wt. lbs.
		W"	D"	H"	
CA899	64	25 1/2	6 1/2	21 3/4	34
CA898	20	16 1/2	6 1/2	11 1/4	12

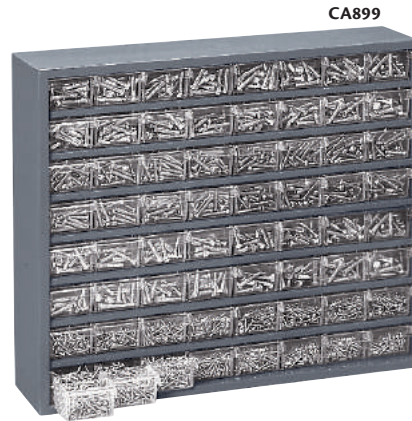

CA899



CA898

MODULAR PARTS CABINETS

- Organize and control small parts inventory
- Standard cabinets come with light grey polystyrene drawers that are virtually indestructible
- Transparent windows on drawer fronts
- Label holder on drawer pull allows for instant identification
- Comes with two removable dividers per drawer
- Stackable steel cabinet frames finished in grey baked enamel
- Cabinet frame dimensions: 17" W x 11" D x 11" H
- **Includes:** Two dividers and one label per drawer

CA853



CA854



CA857



CA858



CA856

Model No.	No. of Drawers	Drawer Dimensions			Wt. lbs.	Dividers Model No.	Replacement Drawers Model No.
		W"	D"	H"			
CA853	28	2 3/16	10 9/16	2 1/16	24	CA859	
CA854	20	3 3/16	10 9/16	2 1/16	21	CC143	
CA856	16	4	10 9/16	2 1/8	20	CA860	
CA857	15	3 3/16	10 9/16	3 1/16	20	CA863	
CA858	9	5 3/16	10 9/16	3 1/16	18	CA865	

AKRO-MILS
CANADA

STEEL DRAWER CABINETS & CARTS

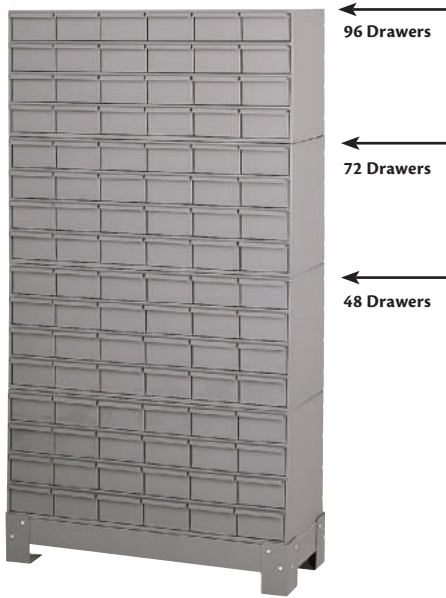

A. 48, 72 & 96-Drawer Cabinets, Base included



B. 18-Drawer Cabinets



D. 9-Drawer Cabinets



C. 24-Drawer Cabinets



E. 30-Drawer Cabinets

INDUSTRIAL DRAWER CABINETS

- Provide a rugged modular storage system for small parts
- Select from a range of drawer capacities from 9 drawers to 96 drawers per cabinet
- Various drawer sizes are available including drawer heights of 2 3/4" and 3 1/2", and drawer depths of 11 1/8" and 17"
- Each drawer includes two adjustable dividers and full width handles
- Drawer sides are slotted to hold dividers

Type	Model No.	No. of Drawers	Drawer Dimensions					Cabinet Height"	Wt. lbs.	Replacement Drawers
			W"	x	D"	x	H"			
A	FI356	30	5 3/8	x	11 1/8	x	3 1/2	26 7/8	107	CD661
A	CA936	48	5 3/8	x	11 1/8	x	2 3/4	33 3/4	176	CA921
A	FI357	60	5 3/8	x	11 1/8	x	3 1/2	48	194	CD661
A	CA939	72	5 3/8	x	11 1/8	x	2 3/4	48 1/8	238	CA921
A	FI358	90	5 3/8	x	11 1/8	x	3 1/2	69 1/8	281	CD661
A	CA941	96	5 3/8	x	11 1/8	x	2 3/4	62 1/2	300	CA921
B	CA924	18	5 3/8	x	11 1/8	x	2 3/4	10 7/8	50	CA921
B	CA925	18	5 3/8	x	11 1/8	x	3 1/2	12 7/8	87	CD661
B	CA926	18	5 3/8	x	17	x	3 1/2	12 7/8	75	CA923
C	CA930	24	5 3/8	x	11 1/8	x	2 3/4	14 3/8	60	CA921
C	CA932	24	5 3/8	x	17	x	3 1/2	17	96	CA923
D	CA942	9	5 3/8	x	11 1/8	x	2 3/4	10 7/8	28	CA921
E	CA934	30	5 3/8	x	11 1/8	x	3 1/2	21 1/8	87	CD661
E	CA935	30	5 3/8	x	17	x	3 1/2	21 1/8	118	CA923
-	CA946	Extra Divider for 2 3/4" H Drawer					-	0.1	-	-
-	CA947	Extra Divider for 3 1/2" H Drawer					-	0.1	-	-

DURHAM MFG
Est. 1922

HEAVY-DUTY 2-SIDED MOBILE CART/WORK STATIONS

- Two rigid and two swivel casters with locking brakes
- Sturdy tubular handle allows ease of mobility
- Rubber tray mat provides safe, secure, non-skid work surface
- Finished in rust and acid resistant grey powder coat
- Heavy-duty casters, capacity of 1000 lbs.
- Shipped fully welded

DURHAM MFG
Est. 1922



Front



- Two 12-compartment bins back-to-back
- Overall dimensions: 34" W x 24" D x 32" H
- Ship weight: 139 lbs.

Model No. CD330



- Two 40-compartment bins back-to-back
- Overall dimensions: 34" W x 24" D x 32" H
- Ship weight: 159 lbs.

Model No. CD349

- One lockable 4-compartment storage cabinet
- One storage bin with 12 compartments
- 12 easily dividable pull out storage drawers, six on each side
- Overall dimensions: 34" W x 24" D x 36" H
- Ship weight: 180 lbs.

Model No. MO070



Back

PLASTIC COMPARTMENT CASES

COMPACT POLYPROPYLENE COMPARTMENT BOXES

- High strength, oil resistant polypropylene, boxes with covers fitted with heavy-duty reinforced hinges
- Hinges have a special "stop" feature which allows the cover to remain in open position
- Covers overlap on all sides of the bottom tray
- Two snap latches assure secure closure
- Stackable



DURHAM MFG
Est. 1922



COMPARTMENT BOX CABINETS

- All steel grey powder coated cabinet holds five plastic compartment boxes
- Bolt holes permit stacking and keyhole slots are furnished for wall mounting
- Convenient carrying handle



Model No.	Overall Dimensions				No. of Compartments	Compartment Dimensions					Wt. lbs.	
	W"	x	D"	x		H"	W"	x	D"	x		H"
CB513	11	x	6 3/4	x	13/4	6	1 3/4	x	6 1/4	x	1 9/16	0.7
CB509	11	x	6 3/4	x	13/4	12	1 3/4	x	3 1/8	x	1 9/16	0.7
CB511	11	x	6 3/4	x	13/4	18	1 3/4	x	2 1/16	x	1 9/16	0.7
CB507	13 1/8	x	9	x	2 5/16	6	2	x	8 1/2	x	2	0.8
CB501	13 1/8	x	9	x	2 5/16	12	2	x	4 3/32	x	2	0.8
CB503	13 1/8	x	9	x	2 5/16	18	2	x	(6) 4 3/4 (12) 2	x	2	0.8
CB505	13 1/8	x	9	x	2 5/16	24	2	x	2	x	2	0.8

COMPARTMENT BOX RACKS

Model No.	Description	Dimensions					Wt. lbs.
		W"	x	D"	x	H"	
CB631	Small Box Rack	11 1/4	x	6 3/4	x	10 3/4	7
CB632	Large Box Rack	13 1/2	x	9 1/8	x	13 1/4	11

COMPARTMENT CASE

- High strength, high quality polypropylene case
- Translucent lid allows for quick view of contents
- Snap latch ensures a secure closure
- Removable dividers allow for different configurations

TLZ117



CF333

aurora tools

Model No.	Overall Dimensions			No. of Compartments	Wt. lbs.
	W"	x	D" x H"		
CF333	10 3/4	x	5 3/8 x 1 1/2	Variable up to 17	0.7
TLZ117	5 3/8	x	5 3/8 x 1 3/8	Variable up to 9	0.3

LARGE CASES

18 1/2" L x 13" W

- Large Super Satchel organize tool cribs, maintenance departments, shop floors and allow complete portability
- See-through lids allow quick identification of contents
- Copolymer resins will not rust
- Brass pinned hinges provide strength and durability
- Identification card holder for quick case selection
- Molded integral feet, making ideal presentation cases

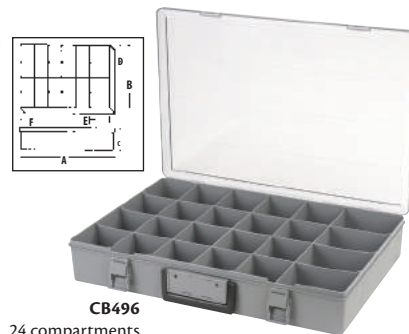
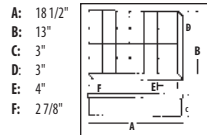

CB496
24 compartments
Wt.: 3.5 lbs.

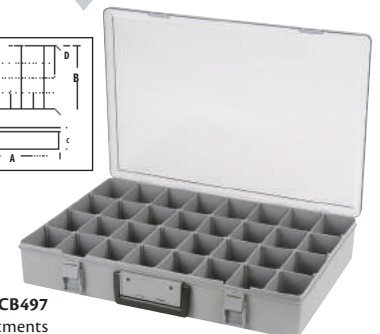
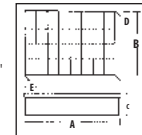

CB497
8 to 32 compartments
24 partitions provided
Wt.: 3.5 lbs.

SMALL CASES

15" L x 11 3/4" W

- Small Satchel store and organize large, medium, small and flat parts, removable partitions
- See-through lids allow quick identification of contents
- Copolymer resins that will not rust or dent
- Brass pinned hinges provide strength and durability
- Divided style (CB499) or double case (CB500) with two cases sonically welded back to back
- Can be stored flat or upright

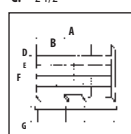
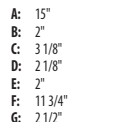

CB499
9 to 24 compartments
Wt. 2.9 lbs.

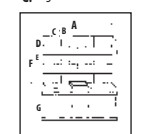
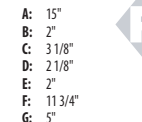

Flambeau



CB500
18 to 48 compartments
Wt. 5.8 lbs.

STORAGE SYSTEMS

TIP-OUT™ BIN MODULAR STORAGE SYSTEMS

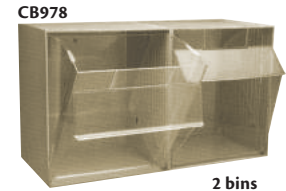

- Each bin has a slot for labeling
- Bins can be completely removed for replenishing or cleaning
- Uniform widths of 23.6" (for units of two to nine bins)
- Can be used free-standing or with stands and pedestals

- Transparent compartments tip out for easy access and viewing
- Two of **CB573** disc and screw set are needed for every bin
- Colour: Beige or grey
- Disc and screw set (**CB573**) is required if the bin rack needs to be mounted on a frame

TILT BINS

Model No.		Mfg. No.	No. of Bins	Bin Dimensions					Cabinet Dimensions					Wt. lbs.
Beige	Grey			W"	x	D"	x	H"	W"	x	D"	x	H"	
CB552	CB553	QTB309	9	23/16	x	13/4	x	2 1/2	23 5/8	x	2 1/2	x	3 1/8	2.0
CB549	CB550	QTB306	6	3 1/2	x	2 5/8	x	3 3/4	23 5/8	x	3 5/8	x	4 1/2	3.0
CB546	CB547	QTB305	5	4 1/4	x	3 3/4	x	5 3/4	23 5/8	x	5 1/4	x	6 1/2	5.0
CB543	CB544	QTB304	4	5 5/8	x	5	x	7 1/2	23 5/8	x	6 5/8	x	8 1/8	7.0
CB540	CB541	QTB303	3	7 3/8	x	5 7/8	x	8 5/8	23 5/8	x	7 3/4	x	9 1/2	9.0
CB977	CB978	QTB302	2	11 1/16	x	8 7/8	x	13 5/8	23 5/8	x	11 7/8	x	13 7/8	14
CB975	CB976	QTB301	1	11 1/16	x	8 7/8	x	13 5/8	11 3/16	x	11 7/8	x	13 7/8	7

CB573 Two discs and two screws set (1 needed for each bin)

TIP OUT™ FRAMES

- Assembly required
- Disc screw set required for each bin cabinet to be mounted on a frame



FRAME ONLY: BINS NOT INCLUDED

Model No.	Description	Dimensions				Bin Quantity Table QTB Series Bins						
		W"	x	D"	x	H"	302	303	304	305	306	309
FLOOR STANDS												
CB562	48" 1-Sided	23 5/8	x	8	x	52	3	5	6	7	11	16
CB563	70" 1-Sided	23 5/8	x	8	x	75	5	7	8	10	15	23
CB565	48" 2-Sided	23 5/8	x	16	x	52	6	10	12	14	22	32
CB568	70" 2-Sided	23 5/8	x	16	x	75	10	14	16	20	30	46
MOBILE FLOOR STANDS												
CB952	48" 2-Sided	23 5/8	x	16	x	52	6	10	12	14	22	32
CB953	70" 2-Sided	23 5/8	x	16	x	75	10	14	16	20	30	46
WALL FRAMES												
CB559	48"						3	5	6	7	11	16
CB561	70"						5	7	8	10	15	23
CB573	Two Discs & Two Screws Set											

HEAVY-DUTY TILT BINS

- Extremely durable ABS plastic housing and drawer body
- Transparent polystyrene front window for easy viewing
- Conveniently connects to each other with grooved channels on top, bottom and sides
- Shake resistant design prevents drawers from opening on their own
- Keyholes on back for wall mounting applications
- Colour: Black and grey



Model No.	No. of Drawers	Bin Dimensions					Cabinet Dimensions					Wt. lbs.
		W"	x	D"	x	H"	W"	x	D"	x	H"	
CF471	8	2 3/4	x	3 1/4	x	3 5/8	11 3/4	x	2 3/4	x	7 7/8	1.8
CF472	6	3 11/16	x	4	x	4 5/8	11 3/4	x	3 1/2	x	9 3/4	2.26
CF473	5	4 1/2	x	4 7/8	x	5 1/2	23 1/2	x	4	x	5 7/8	2.84
CF474	4	5 5/8	x	6 3/8	x	7 1/2	23 1/2	x	5 1/2	x	7 7/8	3.10

MOBILE TILT BIN RACKS

- Heavy-duty steel frame
- Durable powder coat paint finish on galvanized steel
- 3" swivel casters with brake
- Single or double-sided use
- Overall dimensions: 26 1/4" W 22" D x 57 1/2" H
- Colour: Grey



MOUNTING CHANNELS FOR MOBILE TILT BIN RACK

- Single side of mixed size tilt bins, any combination, takes up to six mounting channels per side
- Single side CF473 tilt bins only takes up to eight mounting channels per side
- CF471 and CF472 takes two bin units per level per side

Model No.	Description	Bin Units Included
CF477	Single-Sided	2 of each CF471, CF472, CF473, CF474
CF478	Double-Sided	4 of each CF471, CF472, CF473, CF474
CF475*	Cart Only	-
CF476	Mounting Channel for Tilt Bins	-
CF502	Mounting Channel for Hanging Bins**	-

* Mounting channels and bins not included

** See page B129 for hanging bins

ROTABIN STORAGE UNITS

- Revolving units allow for greater accessibility and visibility
- Shelves sit securely on ball bearings held with a solid steel pin
- Each shelf rotates smoothly and independently

28" DIAMETER

- Six permanent 14 1/2" wide compartments per shelf
- Extra CA221 dividers can be inserted on 1" centres
- Capacity: 500 lbs. per shelf

34" DIAMETER

- Five permanent 21" wide compartments per shelf
- Extra CD463 dividers can be inserted on 1" centres
- Optional removable pans for 34" diameter units allow for easy parts inventory, restocking, transporting to work area or to get weighted
- Capacity: 500 lbs. per shelf

DURHAM MFG
Est. 1922

Model No.	No. of Shelves	No. of Pans*	Unit Height"	Wt. lbs.
UNIT ONLY 28" (PANS NOT AVAILABLE)				
CA193	5	-	38	125
CA194	6	-	41	144
CA195	7	-	47	163
CA196	8	-	53	182
CA197	9	-	60	201
CA198	10	-	66	220
UNIT ONLY 34" (PANS NOT INCLUDED)				
CA225	4	60	35	135
CA226	5	75	43	162
CA227	6	90	50	188
CA228	7	105	66	215
CA229	8	120	66	240
GREY PANS FOR 34" UNIT				
CA258	-	-	-	-

* Max number of pans (pans not included)

17" DIAMETER

- Can be used on counter tops or workbenches
- Each shelf has 4 permanent compartments
- Can have up to 16 compartments per shelf using model CA192 adjustable dividers
- Curved bottom facilitates removal of small parts



CA188

Model No.	No. of Shelves	Unit Height"	Wt. Capacity per Shelf lbs.	Wt. lbs
CA188	4	18 1/2	60	25
CA189	6	26 1/8	60	34
CA190	8	34 1/2	60	43
CA191	10	42 1/8	60	52

Model No.	Description	Wt. lbs.
CA192	Adjustable Divider	0.02



CA229 shown with CA258 pans

STEEL COMPARTMENT CASES

COMPARTMENT STEEL SCOOP BOXES

- Manufactured of prime cold-rolled steel
- Fixed compartment boxes
- Choose from between 8 and 32 fixed compartment boxes
- Small box dimensions: 13 3/8" W x 9 1/4" D x 2" H
- Large box dimensions: 18" W x 12" D x 3" H
- Finished in rust and acid resistant baked enamel
- Boxes have inserts of high impact plastic
- Inserts have rounded scoops, making it easy to remove small parts
- All models have covers designed to stay open
- See chart below for box configurations

DURHAM MFG®
Est. 1922



FIXED COMPARTMENT CONFIGURATIONS, ORDER BY NUMBER OF COMPARTMENTS



LARGE COMPARTMENT BOXES 18" W x 12" D x 3" H

SMALL COMPARTMENT BOXES 13 3/8" W x 9 1/4" D x 2" H

Number of Compartments	Model No.	Wt. lbs.	Model No.	Wt. lbs.
8	-	-	CB032	4
12	CA986	8	CB015	4
16	CA989	8	CB017	4
20	CA992	8	CB023	4
21	CA995	8	CB026	4
24	CA997	8	CB029	4
32	CB002	8	-	-

COMPARTMENT BOX CABINETS

- Carriages extend 100% of the drawers depth for easy access to parts
- Flexibility of removable drawers and a large selection of drawer configurations
- Drawer cabinet may be mounted on a raised base
- Cabinets are available for both the small and large drawer sizes
- Boxes and base are sold separately
- Optional locking hinge (CB037) prevents boxes from sliding out during transport

DURHAM MFG®
Est. 1922

Model No.	Dimensions W" x D" x H"	For Box	Drawer Capacity	Wt. lbs.
CA963	20 x 15 3/4 x 8 1/8	Large	2	20
CA965	20 x 15 3/4 x 15	Large	4	34
CA972	15 1/4 x 11 3/4 x 11 1/4	Small	4	22
CA975	15 1/4 x 11 3/4 x 16 3/8	Small	6	32
CB037	Optional Locking Hinge for CA972	-	-	-
CB038	Optional Locking Hinge for CA965 and CA975	-	-	-



Cabinet and boxes sold separately

ADJUSTABLE COMPARTMENT BOXES

- Adjustable drawers provide the added flexibility of arranging your drawers according to your changing needs
- Removable dividers can be "slotted" into place or removed altogether



DURHAM MFG®
Est. 1922

Model No.	Dimensions W" x D" x H"	Description	Wt. lbs.
CA977	18 x 12 x 3	Large	8
CA979	13 3/8 x 9 1/4 x 2	Small	4

CABINET BASES

- Cabinet bases raise your cabinet/drawer combination 12" off of the floor or workbench
- Models are available to adapt to both small and large drawer size cabinets



DURHAM MFG®
Est. 1922

Model No.	Overall Dimensions W" x D" x H"	For Box	Wt. lbs.
CA980	20 3/8 x 16 x 15 1/8	Large	13
CA983	15 1/2 x 12 1/8 x 15 1/8	Small	12

STACKBIN® CONTAINERS

STEEL STACKBINS®

- Hopper-front steel Stackbins® are available with capacities from 70 cubic inches up to 5100 cubic inches
- They may be easily stacked one on top of another, or housed in steel Stackracks®, together with Stackracks® base allowing lower units to be removed without disturbing units stacked above them
- Standard blue baked enamel finish



PLASTIC STACKBINS®

- CB314 and CB315 are molded of polyethylene and have a capacity of 1600 cu. in.
- The exclusive interlocking front bar prevents the bins from spreading under heavy loads



STACKBIN

Model No.	Capacity Cu. in.	Dimensions				Wt. lbs.	Top Cover Model No.	Front Cover Model No.
		W"	x	D"	x	H"		
CA765	70	4 1/2	x	8	x	4 1/2	-	-
CA766	200	5 1/2	x	12	x	4 1/2	CD369	CD368
CA767	500	7 1/2	x	15 1/2	x	6	CD370	CA734
CA768	900	9	x	18 3/4	x	7 1/2	CA706	CA735
CA772	1400	10	x	24	x	8	CA710	CA739
CA769	1600	12	x	20 1/2	x	9 1/2	CA707	CA736
CA770	2800	15	x	24	x	11	CA708	CA737
CA771	5100	18	x	30	x	12	CA709	CA738

STACKBIN

Model No.		Wt. lbs.
Blue	Grey	
12" W X 20 1/2" D X 9 1/2" H		
CB314	CB315	4

STACKRACKS®

- Stackracks® are designed to be teamed up with Stackbins® to create a heavy-duty storage system
- Stackracks® allow for bins to be removed easily from a setup
- Can support any weight that fits within the cube of the coinciding container
- Easily stack together without tools or fasteners and feature Stackbins® patented locking system
- Can be reconfigured or added to at any time



Shown with 10 - CA769 bins, 10 - CA776 single Stackracks® and 1 - CA693 Base 2 bins wide



12" HIGH BASES

- Can be butt-up to each other to make continuous rows of storage bins
- Bases are made specifically for each size steel container
- 14-gauge legs and supports
- Spot welded
- Capacity: 1000 lbs.

Model No.	Description
1-BIN WIDE	
CA687	For Stackracks® CA775
CA692	For Stackracks® CA776
CA696	For Stackracks® CA778
CA699	For Stackracks® CA779
2-BIN WIDE	
CD448	For Stackracks® CA774
CA688	For Stackracks® CA775
CA703	For Stackracks® CA780
CA693	For Stackracks® CA776
CA697	For Stackracks® CA778
CA700	For Stackracks® CA779
3-BIN WIDE	
CD449	For Stackracks® CA774
CA689	For Stackracks® CA775
CA704	For Stackracks® CA780
CA694	For Stackracks® CA776

STACKBIN

STACKRACKS®

Model No.	Description	Wt. lbs.
CD447	For Bin CA765	3.5
CA773	For Bin CA766	4
CA774	For Bin CA767	5.5
CA775	For Bin CA768	8.5
CA780	For Bin CA772	9
CA776	For Bin CA769	10
CA778	For Bin CA770	12
CA779	For Bin CA771	14

STACKRACKS® COVERS

Model No.	Description
CA715	For CA775
CA730	For CA780
CA720	For CA776
CA724	For CA778
CA727	For CA779

SECTIONAL STACKBINS® SYSTEMS

- Sectional Stackbin® units are an economical alternative to standard Stackbins®
- Individual compartments are created from a standard 37" wide unit divided by welded steel partitions
- Each unit may be stacked on a larger, or similar sized unit, with covers and bases to complete the unit

Model No.	Dimensions				Bins in Section	Wt. lbs.
	W"	x	D"	x	H"	
SECTIONAL STACKBINS®						
CA786*	37	x	8	x	4 1/2	8 11.0
CA787*	37	x	12	x	4 1/2	6 13.8
CA788	37	x	15 1/2	x	6	5 20.0
CA789	37	x	18 3/4	x	7 1/2	4 29.0
CA790	37	x	20 1/2	x	9 1/2	3 35.0
CA791	37	x	24	x	11	2 40.0

* No bases available

Model No.	Description	Model No.	Description
SECTIONAL BASES		SECTIONAL COVERS	
CA793	For CA788	CA797	For CA786
CA794	For CA789	CA798	For CA787
CA795	For CA790	CA799	For CA788
CA796	For CA791	CA800	For CA789
		CA801	For CA790
		CA802	For CA791

STACKBIN



CA791

PRE-ENGINEERED SECTIONAL SYSTEMS

- Complete with sectional Stackbin® 6" high base and top cover
- 5000-lb. stocking capacity

Model No.	Description	Wt. lbs.
USING CA788 SECTIONAL STACKBINS®		
CD354	7 Row Unit w/35 Compartments	136.5
CD355	8 Row Unit w/40 Compartments	156
USING CA789 SECTIONAL STACKBINS®		
CD356	6 Row Unit w/24 Compartments	174
CD357	7 Row Unit w/28 Compartments	226.5
USING CA790 SECTIONAL STACKBINS®		
CD358	5 Row Unit w/15 Compartments	200
CD359	6 Row Unit w/18 Compartments	235
USING CA791 SECTIONAL STACKBINS®		
CD360	4 Row Unit w/8 Compartments	183.5
CD361	5 Row Unit w/10 Compartments	222.5

STACKBIN



CD361

STEEL PARTS STORAGE

STEEL STORAGE BINS

- Pigeonhole type steel storage bin units organize small parts
- Best suited where space is limited and organization is crucial
- Produced of prime cold rolled steel
- Fully welded, will not warp, twist or sag
- Fully hemmed label holders provide adequate space for content identification
- Each divider is hemmed in a tear drop design to avoid sharp edges
- Doors with padlock attachment and bases to raise units are available with most models
- All units are 33 3/4" wide and are available in depths of 12" or 8 1/2"
- 12" deep units feature a 45° slope front for easy removal of parts
- Finished in grey powder coat

DURHAM MFG®
Est. 1922

Perfect for organizing your shop - can be filled with just about anything!



CA154

Base for storage bins

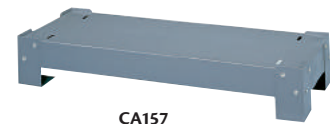

CA157

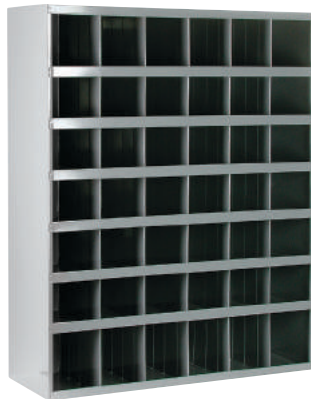

CA151



CA152

Doors for storage bins



CA151 with CA141 and CA157



CA149



CA136



CA133

Model No.	Dimensions					No. of Bins	Bin Dimensions					Wt. lbs.	Base Model No.	Door Model No.
	W"	x	D"	x	H"		W"	x	D"	x	H"			
12" DEEP STORAGE BINS														
CA133	33 3/4	x	12	x	11 1/2	16	4	x	11 7/8	x	5 1/8	25	CA157	-
CA134	33 3/4	x	12	x	19 1/4	18	5 3/8	x	11 7/8	x	6 3/8	38	CA157	-
CA136	33 3/4	x	12	x	23 7/8	24	5 3/8	x	11 7/8	x	5 1/2	44	CA157	CA142
CA149	33 3/4	x	12	x	23 7/8	40	4	x	11 7/8	x	4 1/2	50	CA157	CA142
CA151	33 3/4	x	12	x	42	42	5 3/8	x	11 7/8	x	5 1/2	71	CA157	CA141
CA152	33 3/4	x	12	x	42	56	4 7/8	x	11 7/8	x	5 1/8	75	CA157	CA141
CA154	33 3/4	x	12	x	42	72	4	x	11 7/8	x	4 1/2	68	CA157	CA141
8 1/2" DEEP STORAGE BINS														
CA150	33 3/4	x	8 1/2	x	22 1/4	40	4	x	8 3/8	x	4 1/2	50	CA158	CA148
CA155	33 3/4	x	8 1/2	x	42	72	4	x	8 3/8	x	4 1/2	58	CA158	CA141

EZ-EDGE™ SELF ADHESIVE STRIPS

- Self adhesive strip featuring a bottom guide for easy installation and instant organization
- Made of heavy-duty UV treated PVC
- Clear front and black back are barcode compatible
- Can be trimmed to retro-fit many other bins and shelving products
- No inserts included
- Plastic Colour: Clear
- Thickness: 0.15625"
- Height: 1-1/8", Length: 32-5/8"



Model No.	Description
CF798	EZ-Edge™ Self Adhesive Strips - Pack of 5
CF799	EZ-Edge™ Self Adhesive Strips - Pack of 9

REPLACEMENT INSERTS

OK120	Compatible with all EZ-Edge™ and Tri-Dex™ strips - Inserts per Package: 800
OP955	Compatible with all EZ-Edge™ and Shelf-Clip™ strips - Inserts per Package: 400

BULK STACKING CONTAINERS

- Heavy-duty all-welded construction
- Mesh containers use 2" x 2" x 10 gauge wire mesh
- All containers use a 13-gauge corrugated sheet steel base
- 2" x 2" x 3/16" angle posts
- 4-way fork truck entry with 4" underclearance
- Available with one drop gate or fully enclosed sides
- Height: 24" inside, 30" overall
- Stackable up to five high
- Other sizes are available
- Painted durable Kleton blue



CF449



CF453



CF457



KLETON

Model No.	Description	Dimensions W" x L"	Capacity lbs.	Wt. lbs.
MESH CONTAINERS				
CF449	Fully Enclosed	34 1/2 x 40 1/2	3000	125
CF450	One Drop Gate	34 1/2 x 40 1/2	3000	130
CF451	Fully Enclosed	40 1/2 x 48 1/2	3000	150
CF452	One Drop Gate	40 1/2 x 48 1/2	3000	160
SHEET CONTAINERS				
CF453	Fully Enclosed	34 1/2 x 40 1/2	3500	150
CF454	One Drop Gate	34 1/2 x 40 1/2	3500	150
CF455	Fully Enclosed	40 1/2 x 48 1/2	3500	185
CF456	One Drop Gate	40 1/2 x 48 1/2	3500	185
CORRUGATED CONTAINERS				
CF457	Fully Enclosed	34 1/2 x 40 1/2	4500	160
CF458	One Drop Gate	34 1/2 x 40 1/2	4500	160
CF459	Fully Enclosed	40 1/2 x 48 1/2	4500	195
CF460	One Drop Gate	40 1/2 x 48 1/2	4500	195

COLLAPSIBLE BULK CONTAINER

- Drop gates knock-down with ease
- Quickly collapsed, folded, and stacked for convenient transportation
- Lid sold separately
- Colour: Grey
- Max. Height: 39.4"
- Max. Length: 47.2"
- Max. Width: 39.4"
- No. of Drop Gates: 2
- Material: High-density polyethylene (HDPE)
- Weight Capacity: 2000 lbs.
- Folded Height: 14.2"
- Weight 121.3 lbs. (55 kg.)

Model No. CF862



LID

- For use with Kleton collapsible bulk container
- Material: High-density polyethylene (HDPE)
- Colour: Light Grey
- Weight: 13.2 lbs. (6 kg.)

Model No. CF863

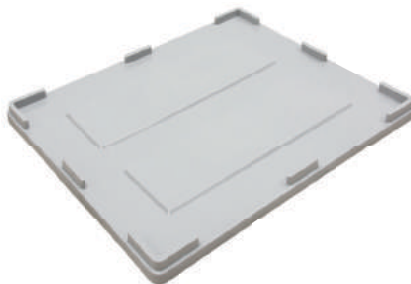

KLETON

OPEN MESH CONTAINERS

- Rugged construction ensures long-lasting, trouble-free service
- 3/4" - 13 gauge expanded metal mesh panels
- Two half drop gates
- 4-way fork truck access
- 4 1/4" underclearance
- Overall dimensions: 34 1/2" W x 40 1/2" L x 32 1/4" H
- Stackable up to five high
- 15 cu.ft. capacity
- Deck capacity: 2500 lbs. mesh deck, 3000 lbs. sheet metal deck
- Blue enamel finish



Model No.	Style	Wt. lbs.
CA397	Mesh Deck	105
CA398	Sheet Metal Deck	114
CA368	Replacement Foot	0.72

STACKING RACKS

- Rugged all-welded 2" square tubing steel construction
- Utilise warehouse airspace and lower the chances of damage that is associated with bulk stacking
- Designed for storage of loose and palletised goods
- Holds 4000 lbs per rack and can be stacked four high
- Posts and bases are sold separately
- Durable Kleton blue enamel finish

KLETON

Model No.	Inside Dim. W" x D"	Overall Dim. W" x D"	Wt. lbs.
OPEN BASE			
RL414	38 x 44	42 x 48	85
RL415	44 x 48	48 x 48	90
CLOSED BASE			
RL416	38 x 44	42 x 48	110
RL417	44 x 44	48 x 48	115

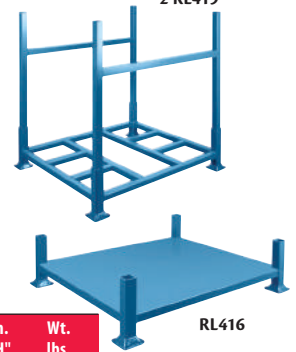

RL414 with 2 RL419

RL416

ACCESSORIES

Model No.	Description	Overall Dim. W" x H"	Wt. lbs.
RL418	42" Side Rail	42 x 48	30
RL419	48" Side Rail	48 x 48	32
RL420	42" Upright Post-Pack of 4	2 x 42	35
RL421	48" Upright Post-Pack of 4	2 x 48	40
RL422	60" Upright Post-Pack of 4	2 x 60	50



COLLAPSIBLE WIRE CONTAINERS

- Welded, square mesh wire allows full visibility and excellent ventilation
- Foldable and constructed of durable 3-gauge wire
- 4-way entry for easy use with lift trucks
- Convenient drop gate design for easy access to products
- Safety rating plates with static load capacity and static load height
- Stack up to four high
- 4" under clearance



NashvilleWire

Model No.	Dimensions W" x D" x H"	Usable Height"	Drop Gate	Mesh Dim."	Cap. lbs.	Wt. lbs.
CF462	20 x 32 x 21	16	32" Side	1 x 1	1000	43
CF463	20 x 32 x 21	16	32" Side	1/2 x 1/2	1000	55
CF464	32 x 40 x 34 1/2	28	40" Side	2 x 2	4000	122
CF465	40 x 48 x 30 1/2	24	48" Side	2 x 2	4000	150
CF466	40 x 48 x 36 1/2	30	48" Side	2 x 2	4000	163
CF467	40 x 48 x 36 1/2	30	40" End	2 x 2	4000	163
CF468	40 x 48 x 42 1/2	36	48" Side	2 x 2	4000	176

PACKAGING SUPPLIES

PROLITE™ HAND STRETCH FILM

- New technology allows lighter gauge to perform like 60-75 gauge films
- Silent and clear film resists puncturing
- 14" x 1500' x 47ga (355 mm x 457m x 12 microns)

Prices are subject to market fluctuations

Model No. PE520



ECOLITE BUBBLE SHIPPING MAILERS

- Self-sealing, protective shipping envelopes offer superior protection
- Their light weight saves on postage cost
- Uniform air bubble construction
- Redefined bubble configuration results in greater strength
- High-slip lining allows for easier product insertion
- Self-seal eliminates the need for tape and staples; offers tamper evident security, faster processing
- 100% recycled kraft material
- Colour: Golden kraft



POLYAIR

Model No.	Code	Size"	Qty /Case	Case Wt. lbs.
PA624	0	6 x 10	250	12.5
PA627	1	7 1/4 x 12	100	7
PA628	2	8 1/2 x 12	100	8
PA631	5	10 1/2 x 16	100	14

STRETCH WRAP DISPENSERS

- For a smooth, tight application of stretch wrap
- Tension control knob on top ensures a tight, smooth wrap; also provides a second hand grip for added stability
- Adjusts to hold rolls from 11" to 18" wide
- Wt.: 4 lbs.

Model No. PE354



STRETCH WRAP

- Conventional cast hand film
- Quiet
- High clarity
- Limited neck down
- Colour: Clear

Prices are subject to market fluctuations



RECLOSABLE POLY BAGS

- Zippered opening allows for easy sealing, opening and resealing
- Keeps out dirt and moisture
- Hang-holes allow user to hang on hooks or pegs
- 2-mil or 4-mil thickness for heavier duty applications
- 1000 bags per case



Model No.	Bag Size"
2-MIL THICKNESS	
PE710	12 x 15
PE712	15 x 20
4-MIL THICKNESS	
PE730	6 x 9
PE104*	9 x 12

Custom sizes and printed bags available. Please inquire.

* 500/case

Model No.	Width"	Length'	Gauge
PF718	14	1476	80 (20.3 micrometers)
PF719	13	1476	75 (19 micrometers)
PF720	13	1476	65 (16.5 micrometers)
PF721	12	1476	47 (12 micrometers)
PF722	18	1500	80 (20.3 micrometers)
PF724	18	1000	120 (30.5 micrometers)
PF725	15	1500	80 (20.3 micrometers)

BANDING FILM

- Premium cast bundling film
- Ideal for unitizing several small items into one package
- Can be applied to the top of a pallet load to enhance stability
- One handle included in each case
- Colour: Clear

Prices are subject to market fluctuations



EXTENDED CORE HAND STRETCH WRAP

- 20" web for faster wrapping
- Cast co-extruded premium film
- 5" extended application handles
- No dispenser required
- Save time and energy
- Colour: Clear

Prices are subject to market fluctuations



Model No.	Width"	Length'	Gauge
PF731	20	1000	80 (20.3 micrometers)
PF732	20	700	120 (30 micrometers)

STRETCH WRAP

- Conventional blown hand film
- Cost effective
- High puncture resistance
- Aggressive cling
- Outstanding containment
- Colour: Opaque Black

Prices are subject to market fluctuations

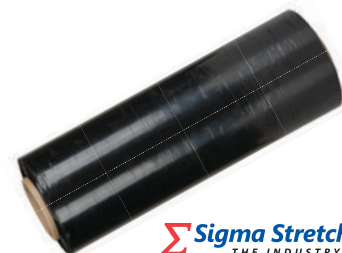

Model No.	Width"	Length'	Gauge
PF723	15	1500	80 (20.3 micrometers)
PF733	18	1500	80 (20.3 micrometers)

CABLE TIES

- Manufactured from Dupont™ Zytel® 101F and Ascend™ Vydyne® 21SPF
- Ideal use in temperatures ranging from -20° C to 80°C
- **PF396** has the added benefit of weather resistance

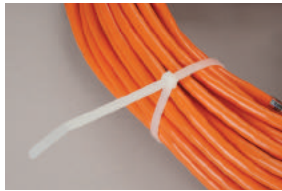

aurora tools

Model No.	Colour	Length"	Bundle Dia. Min"-Max"	Tensile Strength lb	Qty /Bag
PF385	Natural	4	1/16 - 7/8	18	1000
PF386	Black	4	1/16 - 7/8	18	1000
PF387	Natural	6	1/16 - 1 1/4	40	1000
PF388	Black	6	1/16 - 1 1/4	40	1000
PF389	Natural	8	1/16 - 1 3/4	50	1000
PF390	Black	8	1/16 - 1 3/4	50	1000
PF391	Natural	11	1/16 - 3	50	1000
PF392	Black	11	1/16 - 3	50	1000
PF393	Natural	15 1/2	1/16 - 4	120	100
PF394	Black	15 1/2	1/16 - 4	120	100
PF395	Natural	24	3/16 - 7	175	100
PF396	Black	24	3/16 - 7	175	100

HEAVY-DUTY STAPLE GUN

- All-steel construction with rubberized handle for superior grip
- Easy squeeze, double leverage handle reduces operator fatigue
- Hand-contoured handle features molded plastic handle stop
- Bottom loading with jam proof mechanism
- Adjustable driving force facilitates use
- Accepts staples in three lengths: 5/16", 3/8" and 1/2", with a crown width of 3/8"



aurora tools

Model No. PE337

HEAVY-DUTY HAMMER TACKER

- All-steel construction, with rubberized handle for superior grip
- Precision locked rear loading, with jam proof mechanism
- Retractable striking edge
- Chrome-plated finish
- Accepts staples in three lengths: 5/16", 3/8" and 1/2", with a crown width of 3/8"



aurora tools

Model No. PE338

AURORA STAPLES

- Cold rolled steel construction
- 3/8" (10.5 mm) flat crown staples
- For use in most industrial staple guns
- 500 per box



aurora tools

Model No.	Dimensions
ON919	5/16" (8 mm)
ON920	3/8" (10 mm)
ON921	1/2" (12 mm)

HEAT IMPULSE SEALERS

- Used for sealing polyethylene, polypropylene, and PVC bags
- Compact design
- Lightweight
- Easy to operate
- 110 V



KLETON

Model No.	Size"	Power
PF464	8	260 W
PF465	12	380 W

CARTON SIZER

- Ideal for cutting boxes down to the desired depth
- Lowers cost on shipping and packaging fill materials
- 12" ruler allows for precise measuring
- Replacement blade: **PF346**

Model No. PF345



CORRUGATED CARTONS

- 125 to 200-lb. test cartons withstand rough handling during shipment
- Shipped flat to save storage space



Withstands rough handling during shipment

Model No.	Dimensions L' x W' x D"	Test lbs.
-----------	-------------------------	-----------

APPROX. 20 TO 30-LBS. CAPACITY

PA136	6 x 6 x 6	125C
PA137	7 x 4 x 4	125C
PA138	8 x 6 x 4	125C
PA140	8 x 8 x 8	125C
PA141	9 x 6 x 6	125C
PA112	10 x 10 x 10	125C
PA113	11 x 10 x 3	125C
PA132	12 x 12 x 7	125C
PA114	12 x 12 x 12	125C
PA139	13 x 8 x 6.5	125C
PA115	13 x 10 x 10	125C
PA133	14 x 12 x 8	125C

Model No.	Dimensions L' x W' x D"	Test lbs.
-----------	-------------------------	-----------

APPROX. 50-LB. CAPACITY

PB501	14 x 14 x 14	175C
PA116	15 x 11 x 11	175C
PA117	16 x 12 x 10	175C
PA118	16 x 16 x 16	175C
PA122	18 x 12 x 6	175C
PA123	18 x 12 x 9	175C
PA120	18 x 12 x 12	175C
PA121	18 x 15 x 10	175C
PA119	18 x 18 x 18	175C
PA126	20 x 20 x 20	175C
PA111	21 x 14.5 x 15	175C
PA127	21 x 15 x 11	175C
PA124	24 x 19 x 19	175C

Model No.	Dimensions L' x W' x D"	Test lbs.
-----------	-------------------------	-----------

APPROX. 70-LB. CAPACITY

PA125	21 x 20 x 16	200C
PA135	24 x 14 x 24	200C
PA129	24 x 19 x 24	200C
PA131	26 x 19 x 30	200C
PB502	26 x 26 x 26	200C
PB503	30 x 30 x 30	200C
PB504	36 x 36 x 36	200C

PACKING LIST ENVELOPES

- Polyethylene envelopes are 100% waterproof and self-adhesive on any surface
- Will not peel off in transit
- Top loading style
- Once packing list is inserted in envelope, no dirt or moisture can penetrate
- Inside dimensions: 4 1/2" x 5 1/2"
- Weight: 7 lbs.
- 1000 per case

Model No. AMB459
Mfg. No. TC-1



3M

POLY TUBING

- Need special size bags for odd-shaped or extra-large products
- Just cut the length you need, insert your product and seal the ends for a custom fit every time
- 4-mil poly tubing available in 3" width to 24" width,
- 2 mil also available



Model No.	Roll Size"	Roll Dia. (+/-2")	Approx. lbs. Roll	Approx. Length/Roll'
PF105	3	19	25	2604
PF107	5	14.5	25	1563
PF096	6	18.5	50	1832
PF099	8	15.5	50	1563
PF103	10	14.5	50	1562
PF098	12	13	50	1302
PF101	16	11.5	50	977
PF097	24	9.5	50	651

PACKAGING SUPPLIES

BOX SEALING TAPE

TARTAN™ 369 GENERAL PURPOSE

- Offers good holding power for lightweight cartons
- Utility grade polypropylene

SCOTCH® 371 INDUSTRIAL

- Known for its consistent adhesive
- Sticks instantly to any shape or surface



Model No.	Dimensions	Total Thickness	Rolls /Case
TARTAN™ 369 GENERAL PURPOSE			
PB883	2" x 328' (48 mm x 100 m)	1.6 mil, 25 micrometers	36
PC881	2" x 432' (48 mm x 132 m)	1.6 mil, 25 micrometers	48
PA586	2" x 2997' (48 mm x 914 m)	1.6 mil, 25 micrometers	6
SCOTCH® 371 INDUSTRIAL			
PB884	2" x 328' (48 mm x 100 m)	2.0 mil, 30 micrometers	36

TAPE DISPENSERS

- Retractable safety blade protects operator from injury
- Industrial quality tape guns constructed of steel and high impact plastic frame
- Adjustable brake lets you choose the desired release tension

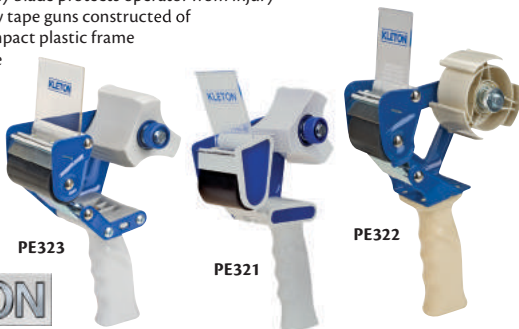

Model No.	Description	Replacement Blade Model No.	Replacement Window Model No.
PE321	2" Standard-Duty Plastic	PE325	PE327
PE322	2" Heavy-Duty Steel	PE325	PE327
PE323	3" Heavy-Duty Steel	PE326	PE329

PRE-PRINTED MESSAGE TAPE

- 3M™ #371 box sealing tape
- All messages are red on white
- Trilingual (English, French, Spanish)
- 48 mm x 100 m rolls

PA601



Model No.	Message	Thickness Microns	Mils	Rolls /Case
PA600	If seal is broken...	30	2.0	36
PA601	Fragile handle with care	30	2.0	36

SCOTCH® ATG TAPE

- Pressure sensitive two-way adhesive can be applied exactly where needed
- Ideal for mounting, splicing or bonding
- Can be used in a broad range of industries, including printing, furniture manufacturing, electronics, appliances, signs and displays, automotive and others
- ATG system applies 2-mils reinforced clear acrylic adhesive and simultaneously rewinds the tape liner inside the dispenser

Model No. PA974
Mfg. No. ATG-700



TAPE

Model No.	Mfg. No.	Description	Rolls/Case
PA612	924-12	1/2" x 108' Tape	72
PA613	924-19	3/4" x 108' Tape	48

BOX SEALING TAPE

- Quality acrylic tape provides consistent performance
- Designed to resist center seam splitting
- Fits on most industrial tape guns
- Elongation at break: 130%
- Colour: Clear



Model No.	Dimensions	Thickness Microns	Mils
PF231	48 mm x 66 m (2" x 216')	40	1.6
PF232	48 mm x 100 m (2" x 328')	40	1.6
PF233	48 mm x 100 m (2" x 328')	50	2.0
PF234	72 mm x 66 m (3" x 216')	40	1.6
PF235	48 mm x 132 m (2" x 432')	40	1.6

HIGHLAND™ 203 MASKING TAPE

- General purpose
- Pressure sensitive
- Ideal for holding, bundling, sealing and non-critical masking
- 55 m (180') per roll



Model No.	Width	Rolls /Case
AMA015	12 mm (1/2")	72
PC049	18 mm (3/4")	48
PC050	24 mm (1")	36
PC051	36 mm (1 1/2")	24
PC052	48 mm (2")	24
PC588	72 mm (3")	12

SCOTCH® PERFORMANCE 231 MASKING TAPE

- Excellent for reducing paint edge buildup
- Leaves no adhesive residue
- Excellent holding capability
- High performance
- Capable of 250°F for 1 hour
- 55 m (180') per roll



Model No.	Width	Rolls /Case
PC538	18 mm (3/4")	48
PC485	24 mm (1")	36
PC539	36 mm (1 1/2")	24
PC531	48 mm (2")	24
PC486	72 mm (3")	12

TARTAN™ 8934 FILAMENT TAPE

- Ideal for light to medium-duty strapping
- Abrasion and moisture resistant
- Allows printing and illustrations to be seen through tape
- 100-lb. tensile strength



Model No.	Dimensions	Rolls /Case
PC595	1/2" x 180' (12 mm x 55 m)	72
PC596	3/4" x 180' (18 mm x 55 m)	48
PC597	1" x 180' (24 mm x 55 m)	36
PC749	2" x 180' (48 mm x 55 m)	24
PE355	1" Filament Tape Dispenser	-

VINYL DUCT TAPE 3903

- General purpose vinyl duct tape
- Ideal for sealing and protecting surfaces and openings from dust, dirt and moisture
- Good for colour coding, general maintenance as well as wrapping and bundling
- Leaves less adhesive residue on surfaces than the traditional cloth duct tapes
- Easy to tear by hand
- 50 mm x 45.5 m (2" x 149.25')
- Thickness: 6.3 mils



Model No.	Colour	Rolls /Case
PB961	Grey	24
PB962	Blue	24
PB963	Green	24
PB964	Yellow	24
PB965	White	24

PAINTERS MASKING TAPE

- Colour: Green
- High quality painting tape adheres to multiple surfaces
- Reliable adhesion resists paint bleed-through
- Removes cleanly in one piece



Model No.	Length	Width
PF690	55 m (180')	25 mm (1")
PF691	55 m (180')	50 mm (2")

MULTI-PURPOSE SILVER DUCT TAPE

- Ideal for many duct and moisture sealing, holding, protecting and bundling applications
- Polyethylene-coated cloth backing
- Rubber adhesive, high tack, easy tear
- 2" x 150' (48 mm x 45.7 m)
- 6-mil thick
- 24 rolls per case



Model No. PE464

UTILITY GRADE DUCT TAPE

- Colour: Silver
- Ideal for a wide variety of projects and applications
- Water resistant
- Easy to tear



Model No.	Length	Width	Thickness
PF689	45 m (150')	50 mm (2")	6 mils
PF688	55 m (180')	50 mm (2")	9 mils

TARTAN™ 3939 SILVER DUCT TAPE

- Ideal for many duct and moisture sealing, holding, protecting, and bundling applications
- Polyethylene coated cloth backing
- Rubber adhesive
- High tack
- Easy tear
- 48 mm x 55 m (2" x 180')
- Thickness: 9 mils



Model No. PC419

TEMFLEX™ ELECTRICAL TAPE

- General purpose, flexible vinyl tape designed for indoor or short term use and bundling
- Temperature rating: -10°C/80°C
- 3/4" x 60' (19 mm x 18 m) per roll
- Thickness: 7 mils
- UL and CSA approved
- 100 rolls per case



Model No. PC695

ELECTRICAL TAPE

- Material: Vinyl Plastic
- Electrical tape for splicing and insulating wires
- For use between -7°C and 80°C
- CSA approved
- Width: 3/4" (19 mm)
- Length: 18 m (60')
- Thickness: 7 mils
- Colour: Black

Model No. XE890



SUPER 77 SPRAY ADHESIVE

- Ideal for permanently adhering lightweight materials to metal, wood and cardboard
- Two actuators: standard (round) and wide (fan) spray patterns
- High tack, fast drying
- Coverage: 163 sq.ft.
- Net content: 16.5 oz
- 12 per case

Model No. PA003



HI-STRENGTH 90 ADHESIVE

- Ideal for adhering to particle board, polyethylene, polypropylene, rubber and wood
- 1" to 3" adjustable spray width
- 1 to 2-minute drying time
- Coverage: 100 sq.ft.
- Net content: 17.6 oz
- 12 per case

Model No. PA001



HI-TACK 76 ADHESIVE

- Ideal for adhering paper, fabric, cork, foil, rubber and more
- Excellent when strength or high temperature resistance is needed
- 1" to 3" adjustable spray width
- Coverage: 100 sq.ft.
- Net content: 18.1 oz
- 12 per case

Model No. PA002



INDUSTRIAL MARKERS & BAGS

FOR COLD SURFACES

B® PAINTSTIK® -50° TO 150°F



The Original ALL Purpose Cold Surface Markers

- Real paint in stick form
- Ideal for long-lasting, weather, fade and abrasion resistant identification
- Leaves bright, highly visible marks on all materials, including asphalt, aluminum, glass, plastic, marble, lumber and steel
- Writes on rough, smooth, oily, wet, dry, icy and rusty surfaces



Model No.	Colour	Model No.	Colour
PA298	White	NE264	Green
PA320	Black	PA300	Orange
PA309	Yellow	PA353	Grey
NE265	Red	PA348	Blue

B-L® BLUE PAINTSTIK® -50° TO 150°F

Makes permanent marks that bleed through painted surfaces. Available in blue only.

Model No. PA356

BALL PAINT MARKER® -50° TO 150°F

- Produce long lasting, weather and water resistant fine line marks with real paint that dries in minutes
- Writes like a pencil on metal, wood, plastics, rubber - any surface or material
- Packaged in unbreakable 2-oz. plastic bottles with cap to prevent drying or leaking



Model No.	Colour	Model No.	Colour
PA339	White	PA345	Green
PA340	Yellow	PA343	Orange
PA341	Red	PA342	Black
PA344	Blue		

RECLOSABLE POLY BAGS

- Zippered opening allows for easy sealing, opening and resealing
- Keeps out dirt and moisture
- Hang-holes allow user to hang on hooks or pegs
- 2-mil or 4-mil thickness for heavier duty applications
- 1000 bags per case

Model No.	Bag Dimensions"
2-MIL THICKNESS	
PE713	2 x 2
PE714	2 x 3
PE716	3 x 3
PA040	3 x 4
PE718	3 x 5
PE720	3 x 6
PE721	4 x 4
PA058	4 x 6
PE724	4 x 8
PE725	5 x 7
PA063	5 x 8
PE729	6 x 6
PE727	6 x 8

Custom sizes and printed bags available. Please inquire.

QUIK STIK® TWIST-UP PAINT MARKERS

- All purpose paint marker for marking metal, wood, glass, plastic, cardboard and more
- Fast drying paint is fade and weather resistant
- 20% more marks than other brands
- Easy-to-use twist-up holder with self-storing cap keeps hands and clothing clean
- 72 per case



Model No.	Colour
PB937	White
PB938	Yellow
PB939	Red
PB940	Black
OP543	Fluorescent Yellow
OP544	Fluorescent Green
OP545	Fluorescent Orange
OP546	Fluorescent Pink

VALVE ACTION® PAINT MARKERS



MARKING RANGE -50° TO 150°F.

- A fast drying, lead free paint marker ideal for all surfaces
- Weather and fade resistant
- Replaceable fibre tip ensures full use of the marker



Model No.	Colour
PA418	White
PA431	Black
PA420	Red
PA422	Green
PA419	Yellow
PA423	Aluminum
PA421	Blue
PE935	Fluorescent Yellow
PE936	Fluorescent Green
PE937	Fluorescent Orange
PE938	Fluorescent Pink

REPLACEMENT TIPS (12/PKG)

Model No. PA424

PRO-LINE HP® MARKERS

- High performance paint marker has unsurpassed writing capabilities on oily, soapy and wet surfaces
- Excellent on most metals, coatings, plastics, glass, ceramics and other non-porous materials
- Low in halogenated compounds and sulphur allowing use in stainless steel and other corrosion sensitive applications



Model No.	Colour
PE507	White
PE508	Yellow
PE509	Red
PE510	Black
PE511	Blue
PE512	Green
PE513	Silver
PE514	Orange

Xylene Free!



Model No.	Bag Dimensions"
2-MIL THICKNESS	
PA071	6 x 9
PE728	6 x 10
PE731	7 x 10
PE733	8 x 8
PA075	8 x 10
PE734	9 x 12
PE708	10 x 10
PA029	10 x 12
PE707	10 x 13
PE709	12 x 12
PE710	12 x 15
PE712	15 x 20

#15 SHARPIE® MARKERS

Fine point marker. Extra tough tip that will not spread or mush. High visibility ink.



Model No.	Colour
PA393	Black
PA395	Blue
PA392	Red

Model No.	Bag Dimensions"
4-MIL THICKNESS	
PE715	2 x 3
PE717	3 x 4
PE719	3 x 5
PE722	4 x 4
PE723	4 x 6
PE726	5 x 8
PE730	6 x 9
PE732	8 x 10
PE104*	9 x 12
PE711	12 x 15

*500 bags/case

HEAVY-DUTY UTILITY KNIVES



PA227



PB861



PA228



PB949



PB834



PA190



PA212



PA224



PA246



PB860

Model No.	Mfg. No.	Description
PA227	L-1	Heavy-Duty Knife
PA228	L-2	Heavy-Duty Knife w/an Ergonomically-Designed Handle that Features a Rubber Grip Insert
PB861	NL-AL	Auto-Lock Heavy-Duty Hand-Saver Utility Knife
PB949	NA-1	Cushion Grip Cutter w/Auto-Lock Blade Slide
PA190	180	Quality at an Economical Price. Features Snap-Off Blades
PA224	H-1	Extra Heavy-Duty Cutter w/Rubber Grip Insert
PB834	SK-4	Carton Cutter Knife w/Self-Retracting Blade for Enhanced User Safety
PA212	CL	18mm Heavy-Duty Utility Knife with Ratchet Lock
PA246	SL-1	All Purpose Utility Knife
PB860	1118008	18 mm All-Over Rubber Grip HD Utility Knife

REPLACEMENT BLADES

Model No.	Use With	Blades /Pkg.
PA238	All Knives Except PA190 and PA224	10
PA239	All Knives Except PA190 and PA224	50
PA199	PA190 and PB949	10
PA731	PA190 and PB949	50
PB835	PB834 Only	10
VQ359	PA224 Only	5
VQ360	PA224 Only	20
PC544	PC563 Only	100

BAG SEALER & TAPE

- Heavy-duty bag sealer with tape cutter
- Easy to use; just twist bag shut and move through slot

Model No. PE356



REPLACEMENT BLADE

Model No. PE383

BAG SEALING TAPE

- 3/8" x 216' PVC tape

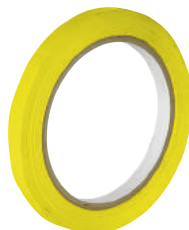

Model No.	Colour
PF208	White
PF209	Yellow
PE538	Red
PF211	Blue
PF212	Green



SNAP IT 'N' TRAP IT HEAVY-DUTY UTILITY KNIVES

- Enables you to renew and dispose up to 16 blade segments quickly
- Features the Olfa silver LB blade, made of premium carbon tool steel for superior sharpness and durability
- Built with high-impact ABS plastic handle for strength
- Tackles the toughest of jobs like cutting drywall, linoleum, rubber and more

Model No. PE987

Mfg. No. DL-1



REPLACEMENT BLADES

Model No. PA238 10/pkg. Mfg. No. LB-10B

Model No. PA239 50/pkg. Mfg. No. LB-50B



SAFETY KNIVES WITH CONCEALED BLADE

- Adjustable blade positioning design which allows for four cutting points on a single-edge blade
- Highly productive, it delivers 4x's more cuts than a single-edge, fixed blade "gooseneck" safety knife
- Uses the Olfa SKB-10 blade
- Fits both right and left-handed users with no blade adjustment necessary

Model No. PE929

Mfg. No. SK-10



REPLACEMENT BLADES

Model No. PE990 10/pkg.

Mfg. No. SKB-10/10B



INDUSTRIAL UTILITY KNIVES



PF710



PF711



PE813



PE345



PE814



PF708



PE549



PE349



PE812



PE812



Model No.	Description
PF708	Self-Retracting Utility Knife
PF710	25 mm, Blade Screw-Lock, Snap-off Blades
PF711	18 mm, Blade Screw-Lock, Snap-off Blades
PE813	Blade Screw-Lock, Comes w/Blade Snapper
PE814	Auto-Lock Blade, Attached Blade Snapper
PE549	Auto-Lock Blade, Lightweight Design
PE345	Attached Blade Snapper
PE349	Blade Screw Lock, Rubber Handle Insert for Superior Grip
PE812	Auto-Reload Blade Change, Auto-Lock Blade, Thumb Operated Screw-Lock for Heavy-Duty Operation, Rubber Handle Insert for Superior Grip, Attached Blade Snapper, Includes 4 Heavy-Duty Blades

REPLACEMENT BLADES

Model No.	Use With
PF709	PF708 Only, 10/Pkg.
PF205	PF711, PE813, PF814, PE549 and PE812, 10/Pkg.
PE407	PE345 and PE346, 10/Pkg.
PE410	PF710 and PE349, 10/Pkg.

PACKAGING SUPPLIES

STEEL STRAPPING

- Strongest material for a wide range of strapping requirements
- Ideal for heavy shipments that require stronger protection over polypropylene and polyester
- Black painted and waxed finished
- Oscillated wound



Model No.	Strap Width"	Core Dimensions"	Strength lbs.	Coil'
PF404	1/2 x 0.020	16 x 3	1200	2940
PF405	5/8 x 0.020	16 x 3	1500	2360
PF406	3/4 x 0.020	16 x 3	1800	1960
PF407*	1 1/4 x 0.031	16 x 1 1/4	5500	760

* Ribbon wound

STEEL SEALS

- All fully galvanized steel
- Open (Snap-on) type:
Used on flat and smooth surfaces
- Fully closed (push) type:
Used on curver and irregular surfaces

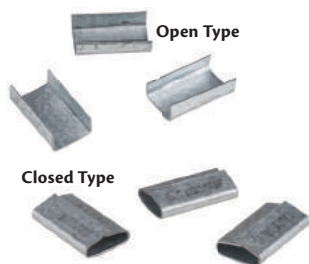

Model No.	Strap Width"	Qty /Box
OPEN (SNAP-ON)		
PF408	1/2	2000
PF409	5/8	2000
PF410	3/4	2000
PF411	1/2	5000
PF412	5/8	5000
PF413	3/4	5000
PF414	1 1/4	1000

Model No.	Strap Width"	Qty /Box
FULLY CLOSED (PUSH)		
PF415	1/2	2000
PF416	5/8	2000
PF417	3/4	2000
PF418	1/8	5000
PF419	5/8	5000
PF420	3/4	5000
PF421	1 1/4	1000

STEEL & POLYPROPYLENE STRAPPING DISPENSER

- Strapping cart is designed to be compatible with both polypropylene and steel strapping
- The unique multi-tier discs accommodate three core strapping sizes: 16" x 3", 16" x 6", and 8" x 8"
- Rubber rollers prevent strapping from unrolling
- Cart includes large storage tray for strapping accessories
- Heavy-duty 8" rubber wheels for easy maneuverability
- For use with 1/2" - 3/4" strapping

Model No. PE555



1/2" STEEL STRAPPING SYSTEMS

EASY-TO-USE, EFFICIENT SYSTEM PROVIDES MAXIMUM STRENGTH PACKAGING, BUNDLING & PALLETIZING

Contains open seals for flat surfaces

Consists of the following components:

- 1- PA528 1/2" x 0.20" steel strapping
- 1- PC446 cutter 3/8" - 1 1/4"
- 1- PC938 3/8" to 3/4" wide standard tensioner
- 1- PA550 1/2" wide sealer for open seals
- 1- PA533 1/2" wide open seals 2000/box
- 1- PE555 dispenser

Model No. PB654



SAFETY CUTTERS FOR STEEL STRAPPING

STANDARD-DUTY

- Cuts steel strapping 3/8-1 1/4" wide x .036" thick
- Safety design holds strapping in place to prevent injuries from flying ends
- Rubber pads gently release strapping when being cut

Model No. PC446



HEAVY-DUTY

- Cuts steel strapping 3/8-2" wide x .050" thick
- Powerful drop-forged steel design
- Heavy-duty performance for industrial applications
- 24" long

Model No. PC479



STEEL STRAPPING TENSIONERS

PUSH BAR STYLE

- Accepts steel strapping 0.020" thick
- Light tension, limited take-up
- Ideal for applications on small, round or irregular surfaces
- For use with push type closed seals



PA567

FEED-WHEEL STYLE

- Accepts steel strapping 0.035" thick
- Fast and easy operation
- Medium/heavy tension, unlimited take-up
- Ideal for applications on flat surfaces
- For use with open seals



PC938

PE350



PUSH BAR STYLE

Model No.	Description	Width"
PA567	Standard	3/8 - 1/2
PC350	Heavy-Duty	3/8 - 3/4

FEED-WHEEL STYLE

Model No.	Description	Width"
PC938	Standard	3/8 - 3/4
PC399	Heavy-Duty	3/4 - 1 1/4

STEEL STRAPPING SEALERS

STANDARD STEEL STRAPPING SEALER, FOR USE WITH OPEN SEALS

- Double notch creates a strong interlocking joint
- Heat-treated steel construction for added durability
- Ball handles provide a superior grip
- Ideal for use with feed-wheel tensioners

Model No.	Width"
PA550	1/2
PA562	5/8
PA551	3/4



STANDARD STEEL STRAPPING SEALER, FOR USE WITH CLOSED & SEMI-CLOSED SEALS

- Single notch
- Chrome-plated steel construction
- Ball handles provide a superior grip
- Ideal for use with push-bar style tensioners

Model No.	Width"
PE351	1/2
PE352	5/8
PE353	3/4



HEAVY DUTY STEEL STRAPPING SEALER

- Single notch
- Heat-treated steel construction for added durability
- Ideal for use with push-bar style tensioners
- For use with 1 1/4" wide steel strapping
- 28" long

Model No. PB016 (closed & semi-closed seals)

Model No. PF687 (open seals)



POLYPROPYLENE STRAPPING

- The most inexpensive of all strapping materials
- Lightweight, easy to apply and recyclable
- Available in both manual and machine grade
- Manual application is ideal for low and moderate volume users
- Ideal for light duty palletizing, unitizing, carton closing and bundling



Model No.	Colour	Strap Width"	Strength lbs.	Coils /Coil"	Coils /Carton	Dim. Core" W"	Wt. lbs.
MACHINE GRADE							
PA526	White	3/8	300	12900	1	8 8	28
PF073	White	1/2	300	9000	1	8 8	31
MANUAL GRADE							
PF079	Black	5/8	500	7500	1	8 8	31
PF067	Black	5/8	700	6000	1	8 8	31
PF078	Black	3/4	1050	4500	1	8 8	31
PF075	Black	1/2	600	7200	1	8 8	31
PF071	Black	1/2	750	5600	1	16 6	40
PF077	Black	5/8	850	6000	1	8 8	31
PF074	Black	5/8	1100	4400	1	16 6	40
PF083	Black	1/2	600	7200	1	16 6	31

SEALS & BUCKLES FOR POLYPROPYLENE STRAPPING



Model No.	Strap Width"	Type	Qty /Box
STEEL SEALS			
PA509	1/2	Open	2000
PA510	5/8	Open	2000
PC886	3/4	Open	1000
PLASTIC BUCKLES			
PA500	3/8	Plastic	1000
PA498	1/2	Plastic	2000
PA499	5/8	Plastic	2000
WIRE BUCKLES			
PA501	1/2	Wire	2000
PA502*	1/2	H.D. Wire	1000
PA503	5/8	Wire	2000
PA504*	5/8	H.D. Wire	1000

*Recommended for strap with strength over 400 lbs.

POLYPROPYLENE STRAPPING SEALERS

- Heat-treated steel construction for superior strength and durability
- Prevents strapping from loosening during transit
- Long 18" handle requires less effort
- Use on steel seals

Model No.	Strap Width"
PA555	1/2
PA556	5/8
PF459	3/4



POLYPROPYLENE & POLYESTER STRAPPING TENSIONERS

- Ideal for applications on flat surfaces
- Accepts strapping 3/8 -3/4" wide
- Superior design and performance
- Premium copper bushings
- Built-in strapping cutter
- For use with open seals or buckles

Model No. PC939



1/2" POLYPROPYLENE STRAPPING SYSTEMS

Consists of the following components:

- 1- PF071 1/2" x 5600', 750-lb. strength poly strapping
- 1- PE555 dispenser
- 1- PA555 1/2" poly sealer
- 1- PC939 polypropylene and polyester tensioner
- 1- PA509 1/2" open seals, 2000/box

Model No. PD023



POLY STRAPPING KIT

- Hand strap large or small packages
- Carton comes complete with polypropylene strapping and steel buckles
- Conveniently stored in a portable cardboard box



Model No.	Strap Width"	Strength lbs.	Feet /Ctn.	Buckles /Ctn.
PF072	1/2	300	3300	360

EDGEBOARD CORNER PROTECTORS

- Improves stocking strength and cushions package edges against hard knocks
- Also helps improve the flow of strapping and stretch film around the product
- 20 per bundle



PRE-BUNDLED PACKS

Model No.	Leg"	Thickness"	Length"
PB264	2.5 x 2.5	0.200	36
PB265	2.5 x 2.5	0.200	42
PB266	2.5 x 2.5	0.200	48
PB267	3 x 3	0.200	36
PB268	3 x 3	0.200	42
PB269	3 x 3	0.200	48

Note: Pallet quantities are available. Other thicknesses and lengths available upon request.

EDGE PROTECTORS

- Plastic edge protectors spread strapping tension across a 2" surface
- Protects packages from surface damage
- 1" L x 1 1/4" W
- For use with strapping up to 3/4" W
- Quantity of 1000 per package
- Priced per package

Model No. PA497



VELCRO® BRAND LOGISTRAP™

- Base material: Nylon with metal buckle
- Applications: Distribution centers, warehouses and logistics
- Working Load Limit: 225 lbs. (102 kg)
- Secure pallet boxes, sleeve packs and collapsible containers
- Reusable straps are cost effective and reduce waste
- Easily and quickly secures goods to a pallet
- Made with VELCRO® brand woven hook and loop
- Style: Hook and Loop
- Length: 16.4'
- Width: 2"
- Colour: Orange

Model No. PF734



VELCRO® BRAND QWIK TIES

- Hook Material: Polypropylene
- Loop Material: Nylon
- Applications: Cable management, medical equipment bundling and materials handling
- Ideal for other applications requiring an adjustable and reusable self-engaging fastener
- VELCRO® Brand Qwik Ties self-gripping fasteners are ideal for cable management applications
- Self-engaging
- Colour: Black
- Width: 3/4"
- Length: 25 yds

Model No. OP759



VELCRO® BRAND STICKY BACK TAPE

- Base Material: Nylon
- Applications: Apparel, office folders, stationery, rigid packaging and trays, medical equipment
- Quantity per pack: 12
- Both Hook and Loop components supplied in package
- Width: 3/4"
- Length: 15'



Model No.	Colour
OP764	Black
OP765	White



VELCRO® BRAND ONE-WRAP® TAPE

- Hook Material: Polypropylene
- Loop Material: Nylon
- Applications: Cable management, medical equipment bundling and materials handling
- Ideal for other applications requiring a strong, durable, adjustable and reusable self-engaging fastener
- Self-engaging
- Strong, reusable ONE-WRAP® fasteners feature hook and loop laminated back to back without glue, so there's no chemical residue
- Colour: Black
- Length: 25 yds



Model No.	Width"
OP622	1/2
OP623	1



VELCRO® BRAND SEW ON ROLL

- Hook and Loop Material: Nylon
- Application: Ideal for applications requiring high cycle life closure
- Hoop 88 and Loop 1000 included in package
- Easy to sew & easy to fasten
- An adjustable alternative to snaps, buttons, zippers, hooks & eyes
- Width: 3/4"
- Length: 30'



Model No.	Colour
OP785	White
OP786	Black



VELCRO® BRAND SEW-ON TAPE

- Base Material: Nylon
- Applications: Apparel, furnishings, straps, medical equipment and fabric applications
- Both Hook and Loop components supplied in package
- Easy to sew & easy to fasten
- An adjustable alternative to snaps, buttons, zippers, hooks & eyes
- Machine washable and dry cleanable
- Width: 1-1/2"
- Length: 15'



Model No.	Colour
OP643	Black
OP644	White



VELCRO® BRAND STICKY BACK SQUARES

- Base Material: Nylon
- Applications: Apparel, office folders, stationery, rigid packaging and trays
- Squares per pack: 12
- Both Hook and Loop components supplied in package
- Ideal for smooth indoor surfaces
- Excellent for keeping things organized and connected
- Perfect for everyday applications
- Diameter: 7/8"



Model No.	Colour
OP639	Black
OP640	White



VELCRO® BRAND ONE-WRAP® ROLL

- Hook Material: Polypropylene
- Loop Material: Nylon
- Applications: Cable management, medical equipment bundling and materials handling
- Ideal for other applications requiring a strong, durable, adjustable and reusable self-engaging fastener
- Self-engaging
- Strong, reusable ONE-WRAP® fasteners feature hook and loop laminated back to back without glue, so there's no chemical residue
- Colour: Black

Model No.	Width"	Length'
OP628	3/4	12
OP629	1-1/2	30



VELCRO® BRAND VELCOIN® HOOK 88

- Base Material: Nylon
- Suggested paired component: Loop 1000
- Applications: Apparel, office folders, stationery, rigid packaging and trays
- Coins per roll: 1028
- Peel and stick coins provide VELCRO® Brand convenience in a precut fastener
- Colour: White
- Diameter: 3/4"

Model No. OP766



VELCRO® BRAND STICKY BACK ROLL

- Hook and Loop Material: Nylon
- Application: Ideal for applications requiring high cycle life closure
- Hoop 88 and Loop 1000 included in package
- Ideal for smooth indoor surfaces
- Excellent for keeping things organized and connected
- Perfect for everyday applications
- Colour: Black
- Width: 3/4"
- Length: 15'

Model No. OP787

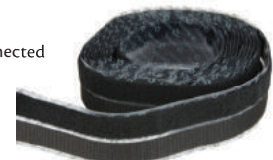

ELECTRONIC DIGITAL WEIGHING SCALES

- Compact design 12 1/2" D x 11 3/4" W x 45/8" H (32 cm x 30 cm x 12 cm)
- Check-weighing function (HI/LO/Target) and a secondary counting function
- Offers four capacities (3, 6, 15, & 30 kg / 6, 12, 30 & 60 lbs.) and four weighing modes (g, kg, lbs., oz.)
- Removable stainless steel platform 11 3/4" D x 8 3/4" W (30 cm x 22 cm)
- ABS enclosure
- Large LCD display with both front and rear indicators and level indicator for weighing accuracy
- Rechargeable battery with low battery indicator and AC adapter (included)

NOT LEGAL FOR TRADE



IA991



Model No.	Mfg. No.	Capacity kg/g/lbs./oz.	Graduation kg/g/lbs./oz.
-----------	----------	------------------------	--------------------------

NOT LEGAL FOR TRADE

IA988	KWS-SW06	3/3000/6/96	0.001/1/0.002/0.05
IA989	KWS-SW12	6/6000/12/192	0.002/2/0.005/0.1
IA990	KWS-SW30	15/15 000/30/480	0.005/5/0.01/0.2
IA991	KWS-SW60	30/30 000/60/960	0.01/10/0.02/0.5

LEGAL FOR TRADE

IA992	KWS-SW06	3/3000/6/96	0.001/1/0.002/0.05
IA993	KWS-SW12	6/6000/12/192	0.002/2/0.005/0.1
IA994	KWS-SW30	15/15 000/30/480	0.005/5/0.01/0.2
IA995	KWS-SW60	30/30 000/60/960	0.01/10/0.02/0.5

WEIGHING SCALES

- Ideal for high humidity and dusty work environments
- Large stainless steel platform is removable for easy cleaning
- Convenient displays on front and rear of the scale allow use from both sides of the worktable
- Meets IP66 (dust tight and protected against a strong water jet) standards

FEATURES:

- Large LCD type display with backlight
- ABS enclosure
- Water and dust resistant
- Secondary counting function
- Four direct keys: Zero, tare, units/counting, on/off
- Four weight modes: g, kg, oz., lbs.
- A/C power or rechargeable battery (not included)
- Dimensions: 9" W x 9 1/2" D x 5 3/4" H

NOT LEGAL FOR TRADE



PE129



Model No.	Mfg. No.	Capacity	Graduation
-----------	----------	----------	------------

NOT LEGAL FOR TRADE

PE126	KWD 500-5	5 lbs./2.5 kg	0.002 lbs./0.001 kg
PE127	KWD 500-10	10 lbs./5 kg	0.005 lbs./0.002 kg
PE128	KWD 500-20	20 lbs./10 kg	0.01 lbs./0.005 kg
PE129	KWD 500-50	50 lbs./20 kg	0.02 lbs./0.01 kg

LEGAL FOR TRADE

IA591	KWD 500-5	5 lbs./2.5 kg	0.002 lbs./0.001 kg
IA592	KWD 500-10	10 lbs./5 kg	0.005 lbs./0.002 kg
IA593	KWD 500-20	20 lbs./10 kg	0.01 lbs./0.005 kg
IA594	KWD 500-50	50 lbs./20 kg	0.02 lbs./0.01 kg

DIGITAL COUNTING SCALES

- Used for counting and quantity checking
- Primary counting function
- High accuracy load cell
- Large LCD display
- Rechargeable battery
- Full digital calibration
- Tare function
- Auto zero tracking
- Quantity set alarm (checking)
- Backlight display
- Accumulation memory quantity
- 1-year warranty

NOT LEGAL FOR TRADE



HX133



Model No.	Mfg. No.	Capacity	Graduation	Counting Resolutions
IB620	KCS 301-6	13.2 lbs./6 kg	0.0004 lbs./0.2 g	1/30 000
IA590	KCS 301-15	33 lbs./15 kg	0.001 lbs./0.5 g	1/30 000
HX133	KCS 301-30	66 lbs./30 kg	0.002 lbs./1 g	1/30 000

COMPACT ELECTRONIC SCALES

- Displays results in grams or combined lb:oz
- One-button operation
- Full capacity tare
- LCD display
- Dimensions: 5.3" W x 7.6" D x 1.5" H
- Weight: 1 lb.
- Operates on three AAA batteries (included) or with an optional AC adapter
- 1-year warranty on parts and labour

HN218



NOT LEGAL FOR TRADE

Model No.	Mfg. No.	Capacity	Graduation
HN218	CS200	0 lb:7.05 oz/200 g	0.01 oz/0.1 g
HN219	CS2000	4 lb:6.55 oz/2000 g	0.05 oz/1.0 g
HN220	CS5000	11 lb:0.4 oz/5000 g	0.1 oz/2.0 g
IB538	-	Optional AC Power Adapter	

BRIEFCASE/UTILITY MECHANICAL RECEIVING SCALES

- These general purpose, portable weighing scales can be used in shipping and receiving areas.
- The large dual dial is easy to read from either the top or side position.
- The memory lock lever will hold the reading when dial is obscured by an oversized package.

NOT LEGAL FOR TRADE

HL933



Model No.	Mfg. No.	Capacity	Graduation	Dimensions L" x W" x H"		
HL933	P250	250 lbs.	1 lb	13 1/4	x 10 1/2	x 3 7/8
HX655	P1145	114 kg	0.5 kg	13 1/4	x 10 1/2	x 3 7/8

SCALES

DEFENDER™ 3000 PLATFORM SCALES

- Ideal for general weighing and simple counting applications in production, packaging, warehouse, inventory, shipping and receiving areas
- Ideal for bench and floor scale applications
- Indicator features a high-impact durable ABS housing with reversible rear cover for either wall, column or table-top mounting
- Large, backlit LCD display quickly displays results in a choice of multiple weighing units (lb., oz, combined lb:oz, kg or g)
- Parts counting mode with a minimum average piece weight of 1d, selectable sample sizes, and automatic retention of last sample size used and average piece weight data
- Built-in bidirectional RS232C for printing or connection to PC
- Includes an AC adapter and an internal rechargeable lead acid battery that lasts 100-hours between recharges
- Platform dimensions: 19.7" x 25.6" / 500 mm x 650 mm



IA555



NOT LEGAL FOR TRADE

Model No.	Mfg. No.	Capacity	Graduation
IA555	D31P150BX	300 lbs./150 kg	0.05 lbs./0.02 kg
IA556	D31P300BX	600 lbs./300 kg	0.1 lbs./0.05 kg

RECEIVING SCALES

These scales are heavy-duty, general purpose and are suitable for light industrial or shipping applications. The easy-to-read indicator is connected to the base by an 8' coiled cord that allows convenient remote placement. Large removable stainless steel platform allows for easy clean up. A keypad toggle allows easy kg/lbs. selection.

NOT LEGAL FOR TRADE



HX632

FEATURES:

- Kg/lbs. modes
- Programmable Auto-Off function
- Removable stainless steel platform (HX632, HX633, IA558, IA782, and IA783)
- Fixed mild steel checkered platform (IA564 and IA558)
- 4 1/2" x 1 1/2" LCD display (HX632, HX633 and IA558)
- 3" x 1 1/4" LCD display (IA564 and IA453)
- Platform dimensions: 11 3/4" x 12 1/4" (HX632, HX633, IA558, IA564 and IA453) 14" x 16" (IA752 and IA783)
- Zero, tare and kg/lbs. (toggle) keys
- Heavy-duty 8' coiled cord
- Power supply: Six AA alkaline batteries (not included) or 120 V AC adapter (included)
- 1-year warranty



Model No.	Mfg. No.	Capacity	Graduation
HX632	KPS-50-2	110 lbs./50 kg	0.05 lbs./20 g
HX633	KPS-100-2	220 lbs./100 kg	0.1 lbs./50 g
IA558	KPS-150-2	300 lbs./150 kg	0.2 lbs./100 g
IA564	KPS-68MS	150 lbs./68 kg	0.2 lbs./100 g
IA782	KPS-60SS	130 lbs./60 kg	0.05 lbs./20 g
IA783	KPS-150SS	330 lbs./150 kg	0.1 lbs./50 g
IA453	KPS-180MS	400 lbs./180 kg	0.5 lbs./200 g

PORTION CONTROL SCALE

- Auto off (after 120 seconds of inactivity)
- Full tare capacity
- Bright-blue backlit LCD display
- Low battery and overload indications
- Stainless steel platform
- Transparent cover protects the scale when not in use
- 7 Weighing modes: kg, lbs., g, oz., lb-oz, lb-1/4oz, 1/4oz
- Power supply: 4 x AA rechargeable batteries and power adapter included
- Capacity: 33 lbs. / 15 kg.
- Graduations: 2 g
- Platform Dimensions: 7" L x 7" W

Model No. IB735
Mfg. No. 6015C



NOT LEGAL FOR TRADE

HANDIFOR® MINI WEIGHER LOAD INDICATOR

- Built to measure small forces or loads in different environments
- Temperature range: from -10°C to 50°C (14°F to 122°F)
- Units of measure: lbs. and kg
- 9/16 in. (14 mm) LCD digits
- Power supply: two 1.5 V "AAA" batteries
- IP 40 protection
- Supplied with a snap shackle and a "S" hook



Model No.	Mfg. No.	Accuracy lbs. (tons)	Increment lbs./kg	Working Load Limit lbs./kg
LV247	199919	± 0.2 / 0.1	0.2/0.1	40 (0.02)
LV248	199929	± 0.6 / 0.3	0.4/0.2	100 (0.05)
LV249	199939	± 1.1 / 0.5	0.4/0.2	200 (0.1)
LV250	199949	± 2.2 / 1	1.1/0.5	400 (0.2)

INDUSTRIAL HANGING SCALES

- Cast aluminum scratch resistant body
- Clear shatter resistant face plate
- 7.5" diameter, kg and lbs. dial
- Heavy-duty welded steel shackle ring
- Large pointed J-hook
- 1-year warranty

IA545



NOT LEGAL FOR TRADE



Model No.	Mfg. No.	Capacity	Graduation
IA543	KHS-C360	60 kg/125 lbs.	200 g/0.5 lbs.
IA544	KHS-C3120	120 kg/250 lbs.	500 g/1 lbs.
IA545	KHS-C3250	250 kg/540 lbs.	1 kg/2 lbs.

MINI DIGITAL CRANE SCALES

- Stainless steel load receptor
- Cast aluminum housing
- LCD screen viewable from 22'
- Tare, Hold, Unit (between kg and lbs.), Zero
- Programmable auto-off, auto-zero, manual zero, backlight
- Removable hook for easy cleaning
- For use in a dry environment and areas of low humidity
- 1-year warranty

IA787



NOT LEGAL FOR TRADE



Model No.	Mfg. No.	Capacity	Graduation
IA784	KHS 200-30	60 lbs./30 kg	0.02 lbs./ 0.01 kg
IA785	KHS 200-60	120 lbs./60 kg	0.05 lbs./ 0.02 kg
IA786	KHS 200-150	300 lbs./150 kg	0.1 lbs./ 0.05 kg
IA787	KHS 200-300	600 lbs./300 kg	0.2 lbs./ 0.1 kg

SCALES

CYCLONE BENCH AND PLATFORM SCALE

- Durable thick stainless steel platter allows for heavy loads without bending
- 2 scales in one - Dual range- always the right sensitivity no matter how light or heavy the load
- Back support - Ideal for weighing products in bags or that which require extra support.
- Post mounted indicator - Makes it easy to see the screen
- Three weighing modes: lb., kg, pcs
- Ideal for shipping, receiving, check weighing or counting
- Battery or adapter operated



NOT LEGAL FOR TRADE

Model No.	Capacity Range 1	Graduation Range 1	Capacity Range 2	Graduation Range 2
15-3/4" L x 19-7/10" W				
IB770	0-60 kg / 0-150 lbs.	20 g / 0.05 lbs.	60-150 kg / 150-300 lbs.	50 g / 0.1 lbs.
17-3/4" L x 23-3/5" W				
IB771	0-150 kg / 0-300 lbs.	50 g / 0.1 lbs.	150-300 kg / 300-600 lbs.	100 g / 0.2 lbs.

VN SERIES ECONOMICAL FLOOR SCALES

The Ohaus VN Series of floor platforms and scales are the value solution to your dry weighing needs in industrial and commercial applications. Its high-quality construction is designed to minimize distortion under heavy loads, and ensures years of dependable performance. NTEP certification ensures consistent weighing results.

Standard features of the VN Series include:

- 5 mm/0.196" painted carbon steel weighing platform top plate with raised cross-hatch surface for added slip resistance
- Four NTEP-certified shear beam load cells protected to IP67
- Side-access NEMA 4X/IP65 dust and water protected stainless steel junction box with 16 1/2' indicator cable
- Four self-swiveling ball-in-cap feet, with top-access leveling adjustment for easy installation
- Internal structural bracing ensures platform rigidity
- Carbon steel eyebolts attached to side of platform for easy lifting and positioning
- T31P indicator includes: Backlit LCD display with 1" high digits, lbs. and kg weighing units, counting mode for inventory applications, 16 1/2' indicator cable, wall bracket for easy mounting, 80-hour internal rechargeable battery and AC adapter

NOT LEGAL FOR TRADE

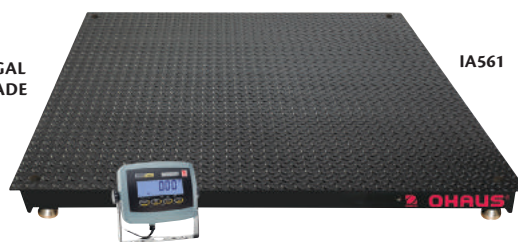

Model No.	Mfg. No.	Capacity	Graduation	Platform Dim. L" x W" x H"
IA560	VN31P5000L	5000 lbs./2500 kg	1 lbs./0.5 kg	48 x 48 x 3 1/2
IA561	VN31P5000X	5000 lbs./2500 kg	1 lbs./0.5 kg	60 x 60 x 3 1/2
IA562	80252565		Floor Ramp, 4' Wide	
IA563	80252566		Floor Ramp, 5' Wide	

TOP LOADING SCALES

- Large stainless steel and enamel platforms to accommodate a variety of package sizes
- Bold graphics improve reading accuracy and ease
- Portable, rugged and reliable

NOT LEGAL FOR TRADE



Model No.	Mfg. No.	Capacity	Case Finish	Platform Dim. W" x D"
PE446	KAM1101PL	11 lbs./5 kg	Enamel	7 1/2 x 7 1/2
PE447	KAM2501SPL	26 lbs./12 kg	Stainless Steel	7 1/2 x 7 1/2
PE449	KAM5002PL	50 lbs./22 kg	Enamel	10 3/4 x 9 1/2

TOP LOADING SCALES

- Brushed stainless steel body and stainless platform
- Portable rugged and reliable
- Bold large numbers for easy readability
- Rotating dial
- Tare function



Model No.	Mfg. No.	Capacity	Graduation	Platform Dim. L" x W"
NOT LEGAL FOR TRADE				
IB736	620SC	2.2 lbs./1 kg	5 g/0.25 oz.	6 x 6
IB737	6215C	5 lbs./2.2 kg	5 g/0.5 oz.	6 x 6
IB738	6225C	25 lbs./12 kg	50 g/0.125 lbs.	8 x 8

RECYCLING CONTAINERS

RECYCLING CONTAINERS, TOPS & BOXES

For use in areas of high paper generation, such as near copiers, printers and in mailrooms.

- Serves as a convenient central collection site for multiple workstations
- Recycling boxes are perfect for curbside recycling programs
- Contains post-consumer recycled resin (PCR) exceeding EPA guidelines



Model No.	Mfg. No.	Description	Capacity US Gal.	Dimensions"	Colour	Wt. lbs.
STATION CONTAINERS						
NH779	3958-73	Square Recycling Container with Recycle Symbol	35	19 1/2 sq x 27 5/8 H	Dark Blue	9.86
NH780	3959-73	Square Recycling Container with Recycle Symbol	50	19 1/2 sq x 34 1/4 H	Dark Blue	13.47
STATION CONTAINER TOPS						
NH763	2791	Untouchable® Bottle and Can, Recycling Top, Fits NH779, NH780 Containers	-	-	Dark Blue	7.05
NH764	2794	Untouchable® Paper Recycling Top, Fits NH779, NH780 Containers	-	-	Dark Blue	7.05
RECYCLING BOXES						
JC060	5714-73	Recycling Box	14	20 3/4 L x 16 W x 14 3/4 H	Blue	4.5
JC061	5714-73	Recycling Box	14	20 3/4 L x 16 W x 14 3/4 H	Green	4.5
JC062	5718-73	Recycling Box	18	25 3/4 L x 16 W x 14 3/4 H	Blue	5
JC063	5718-73	Recycling Box	18	25 3/4 L x 16 W x 14 3/4 H	Green	5

RECYCLING CONTAINERS

- Promote fast, easy and efficient recycling collection
- All-plastic construction will not rust, chip or peel
- Blue colour in a variety of shapes and capacities to suit your workspace
- Recycling symbol imprinted on the containers
- Contains post-consumer recycled resin (PCR) exceeding EPA Guidelines



A. DESKSIDE CONTAINERS

- Designed to be used with existing office containers and accessories
- Easy and effective way to collect waste paper
- JC134 fits inside or outside of deskside containers - allows for easy separation of trash and recycling

Model No.	Mfg. No.	Capacity US Qt.	Dimensions L" x W" x H"	Wt. lbs.
NG274	2955-73	13 5/8	11 3/8 x 8 1/4 x 12 1/8	2
NA737	2956-73	28 1/8	14 3/8 x 10 1/4 x 15	2
NG277	2957-73	41 1/4	15 1/4 x 11 x 19 7/8	3
JC134*	2950-73	4 3/4	10 5/8 x 7 1/4 x 11 1/2	0.75

*Fits NA737 & NG277 only

B. STATION CONTAINERS

- Serves as a convenient central collection site for multiple workstations
- For use in areas of high paper generation, such as near copiers, printers and in mailrooms
- Available in Untouchable® containers, half, round and square and Slim Jims®

Model No.	Mfg. No.	Description	Capacity US Gal.	Dimensions L" x W" x H"	Wt. lbs.
UNTOUCHABLE® CONTAINERS					
NG279	3520-73	Half Round	21	21 x 11 x 28	8
JB606	3569-73	Square	23	16 x 15 x 31	7
JB607	2689-88	Swing Top - Black	-	16 x 16 x 4	3
SLIM JIM® CONTAINERS					
JB524	FG354007BLUE	Slim Jim® Container w/Recycling Symbol	23	22 x 11 x 30	7.75
NG266	2703-88	Slim Jim® Paper Top w/No Imprint	-	20 1/2 x 11 5/16 x 2 3/4	3
JB525	2673-60	Slim Jim® Untouchable® Top w/No Imprint	-	20 1/2 x 11 3/8 x 5	3

C. COLLECTION CONTAINERS

- Serves as a central collection container or shipping container, reducing the amount of handling
- Transport recyclable waste with ease and efficiency
- 8" rubber casters on dolly, sold separately
- Colour of dollies: Black

Model No.	Mfg. No.	Description	Capacity US Gal.	Dimensions"	Wt. lbs.
BRUTE® CONTAINERS					
NG288	2620-73	Round	20	19 1/2 Dia. x 22 7/8 H	7
NA697	2632-73	Round	32	22 Dia. x 27 1/4 H	11
JE165	2643-73	Round	44	24 Dia. x 31 1/2 H	14
NA704	2640	Round Dolly for 20, 32 and 44 US gal. Containers	-	18 Dia. x 5 1/4 H	8
NG292	3536-73	Square	40	23 1/2 sq. x 28 3/4 H	15
NA757	3530	Square Dolly for 28 and 40 US gal. Containers	-	17 1/4 sq. x 6 1/4 H	7

RECYCLING CONTAINERS

GLUTTON® RECYCLING STATIONS

- All-plastic construction resistant to corrosion and withstands impacts

GLUTTON® STATIONS

- Two Glutton® containers, four Slim Jim® containers, one station lid frame, eight restrictive-opening tops (four circles, two slots, one square, one triangle) and one label pack containing both iconic labels and word labels in three languages (English, French, Spanish)
- Dimensions: 53" L x 24" W x 35.3" H
- 92-gallon capacity

Model No. JB612 Mfg. No. 1792372 Dark Blue

Model No. JB613 Mfg. No. 1792374 Beige



1/2 GLUTTON® STATIONS

- One Glutton® container, two Slim Jim® containers, one lid, three restrictive openings and label pack
- Dimensions: 26.8" L x 24" W x 35.3" H
- 46-gallon capacity
- Colour: Dark blue

Model No. JC092 Mfg. No. 1792339

SLIM JIM® WITH VENTING CHANNELS

- Durable, all-plastic construction
- Efficient size and shape fits tight spaces
- Venting channels reduces lifting force by 68% on average, which enhances workplace ergonomics
- Integrated handles allow for easier lifting
- Available with universal recycling symbol imprint
- Stainless steel dolly resists rusting, provides easy mobility and fits all Slim Jim® containers
- Bases and tops sold separately



Model No.	Mfg No.	Capacity US Gal.	Description	Dimensions			Colour
				L"	W"	H"	
JH509	1955959	16	Slim Jim® Container	22	x 11	x 25	Black
JH510	1956181	16	Slim Jim® Container	22	x 11	x 25	Brown
JH511	1955960	16	Slim Jim® Container	22	x 11	x 25	Green
JH295	1971257	16	Slim Jim® Container	22	x 11	x 25	Blue
JH296	1971258	16	Slim Jim® Container	22	x 11	x 25	Grey
JH297	1971259	16	Slim Jim® Container	22	x 11	x 25	Beige
JH512	1956187	23	Slim Jim® Container	22	x 11	x 30	Brown
JH513	1956185	23	Slim Jim® Container	22	x 11	x 30	Blue
JH514	1956186	23	Slim Jim® Container	22	x 11	x 30	Green
JH515	1956188	23	Slim Jim® Container	22	x 11	x 30	Yellow
JH516	1956189	23	Slim Jim® Container	22	x 11	x 30	Red
JB519	3540-60	23	Slim Jim® Container	22	x 11	x 30	Black
JB520	3540-60	23	Slim Jim® Container	22	x 11	x 30	Beige
JB521	3540-60	23	Slim Jim® Container	22	x 11	x 30	Grey
JB523	3540-07	23	Slim Jim® Container w/Recycling Symbol	22	x 11	x 30	Green
JB524	3540-07	23	Slim Jim® Container w/Recycling Symbol	22	x 11	x 30	Blue
JB525	2673-60	-	Swing Top	20.5	x 11.4	x 5	Black
NA723	2673-60	-	Swing Top	20-3/8	x 11-3/8	x 4-3/4	Grey
JB529	2674	-	Hinge Top	21.9	x 13.45	x 1.24	Black
NG268	2692-88	-	Bottle & Can Recycling Top	-	-	-	Brown
JB530	3553	-	Slim Jim® Dolly	20.3	x 9.3	x 9.5	Stainless Steel
JH476	1980602	-	Slim Jim® Trolley	-	-	-	Polypropylene

WASTE BIN

- Plastic construction prevents rusting, chipping and peeling
- Lids sold separately
- Optional trolley allows for easy movement of waste bin
- Capacity: 16 US gal.
- Material: Plastic



Model No.	Description	Colour	Opening
JH485	Container	Grey	-
JH480	Lid	Blue	Rectangle
JH481	Lid	Red	Round
JH482	Lid	Yellow	Round
JH483	Trolley	-	-
JH484	Trolley Hooks	-	-

RMP® GARBAGE BAGS

- Bags are "Best in Class" on attributes such as energy use, amount of recycled material, post consumer waste retrieved and re-used
- Quality of these "green bags" is as good as "non-green bags"
- Excellent strength and puncture resistance eliminate the need for double bagging
- Excellent performance when compared to standard in the category
- Certified UL ECOLOGO® by a well recognized Canadian third party certification body
- UL ECOLOGO® certified bags are less harmful for the environment



Model No.		Dimensions"	Description	Qty /Case
Black	Clear			
JD130	JD146	20 x 22	Utility (0.6 mil)	500
JD131	JD147	22 x 22	Utility (0.6 mil)	500
JD132	JD148	24 x 22	Utility (0.6 mil)	500
JD133	JC835	22 x 24	Utility (0.6 mil)	500
JD134	JD150	26 x 36	Regular (0.8 mil)	250
JD135	JD151	26 x 36	Strong (1.1 mil)	200
JD136*	JD152	26 x 36	X-Strong (1.2 mil)	125
JD137	JD153	30 x 38	Regular (0.8 mil)	250
JD138	JD154	30 x 38	Strong (1.1 mil)	200
JD139	JD155	30 x 38	X-Strong (1.2 mil)	150
JD140	JD156	35 x 50	Regular (0.8 mil)	250
JD141	JD157	35 x 50	Strong (1.1 mil)	200
JD142	JD158	35 x 50	X-Strong (1.2 mil)	150
JD143	JD159	42 x 48	Regular (0.8 mil)	250
JD144	JD160	42 x 48	Strong (1.1 mil)	200
JD145	JD161	42 x 48	X-Strong (1.2 mil)	150

BULLSEYE™ RECYCLING CONTAINERS

- Ideal for the separation of recyclables
- Round hole for cans and bottles or a rectangular slot for paper
- Colour: Blue
- Other colours available (sandstone, greenstone and granite grey)
- Decals sold separately



Model No.	Capacity Gal.	Opening	Dimensions		
			L"	W"	H"
NA804	16	Round	20 1/2	x 11	x 34
NA806	30	Round	20 1/2	x 20 1/2	x 34
NA805	16	Rectangular	20 1/2	x 11	x 34
NA807	30	Square	20 1/2	x 20 1/2	x 34

DECALS

Model No.	Description	Language
JD326	Glass Only	Bilingual
JD327	Plastic Only	Bilingual
JD328	Paper Only	Bilingual

WASTE CONTAINERS

BRUTE® VENTED CONTAINERS, TOPS & DOLLIES

- Extra strong polyethylene construction withstands bumps and kicks; will not rust, chip or peel
- Nest for easy storage and cleans easily due to seamless construction
- Pro-Touch™ handle grips allow for comfortable gripping and lifting
- Four cinches on container enable users to secure bags to container
- Choice of snap-on flat lid or dome top
- Dome top turns container into a rugged outdoor receptacle
- Door swings shut to keep out water and trap odours
- Dome top also fits 45-gallon steel drums
- Twist-on round 5-wheel dolly fits 20-55 US gallon containers
- Universal 5-wheel dolly fits any size round Brute® container and supports up to 500 lbs.
- Internal venting channels allow for easy removal of garbage bags

Note: Items shown in rim caddy NI596 are not included.



NA694



NA701



Model No.	Mfg. No.	Description	Capacity US Gal.	Dimensions			Colour	Wt. lbs.
				Dia."	x	H"		
NA685*	2610	Brute® Vented Container	10	15 5/8	x	17 1/8	Grey	3
NA686*	2610	Brute® Vented Container	10	15 5/8	x	17 1/8	White	3
NA683*	2609	Flat Lid	-	16	x	1	Grey	1
NA684*	2609	Flat Lid	-	16	x	1	White	1
NA691*	2620	Brute® Vented Container	20	19 1/2	x	22 7/8	Grey	7
NA692*	2620	Brute® Vented Container	20	19 1/2	x	22 7/8	White	7
NA693*	2620	Brute® Vented Container	20	19 1/2	x	22 7/8	Yellow	7
NG250	2620	Brute® Vented Container	20	19 1/2	x	22 7/8	Blue	7
NA687*	2619	Flat Lid	-	19 7/8	x	1 1/4	Grey	2
NA688*	2619	Flat Lid	-	19 7/8	x	1 1/4	White	2
NA689*	2619	Flat Lid	-	19 7/8	x	1 1/4	Yellow	2
NA698*	2632	Brute® Vented Container	32	22	x	27 1/4	Grey	11
NA699*	2632	Brute® Vented Container	32	22	x	27 1/4	White	11
NA700*	2632	Brute® Vented Container	32	22	x	27 1/4	Yellow	11
NG251	2632	Brute® Vented Container	32	22	x	27 1/4	Blue	11
NG551	2632	Brute® Vented Container	32	22	x	27 1/4	Red	11
NA694*	2631	Flat Lid	-	22 1/4	x	1 3/8	Grey	3
NA695*	2631	Flat Lid	-	22 1/4	x	1 3/8	White	3
NA696*	2631	Flat Lid	-	22 1/4	x	1 3/8	Yellow	3
NA701	2637	Dome Top	-	22 11/16	x	12 1/4	Grey	15
NA703*	2637	Dome Top	-	22 11/16	x	12 1/4	Red	15
JB463*	2643	Brute® Vented Container	44	24	x	31 1/2	Grey	14
NA706*	2643	Brute® Vented Container	44	24	x	31 1/2	White	14
JB465*	2643	Brute® Vented Container	44	24	x	31 1/2	Yellow	14
JB466	2643	Brute® Vented Container	44	24	x	31 1/2	Blue	14
JB467*	2645	Flat Lid	-	24 1/2	x	1 1/2	Black	2.5
JB616*	2645	Flat Lid	-	24 1/2	x	1 1/2	White	2.5
JB618*	2645	Flat Lid	-	24 1/2	x	1 1/2	Yellow	2.5
NA712	2647	Dome Top	-	24 13/16	x	12 19/32	Grey	16
NA713	2647	Dome Top	-	24 13/16	x	12 19/32	Red	16
NA716*	2655	Brute® Vented Container	55	26 1/2	x	33	Grey	16
NA715*	2654	Flat Lid	-	26 3/4	x	2	Grey	4
NA717	2657	Dome Top	-	27 1/4	x	14 1/2	Grey	17
NA718	2657	Dome Top	-	27 1/4	x	14 1/2	Red	17
NA704	2640	Twist-On Dolly	20 - 55	18	x	6 1/2	Black	8
NA714	2650	Universal Dolly	10 - 55	24 3/8	x	7 1/8	Black	17
NI596	9W87	Rim Caddy for 44-Gallon Container (32 1/2 L" x 26 1/2 W" x 6 3/4 H")					Yellow	5

* Accepted for use in Canadian food processing facilities

JB463



NA704



NA714



SQUARE BRUTE® CONTAINERS, TOPS & DOLLIES

- Extra strong polyethylene construction withstands bumps and kicks; will not rust, chip or peel
- Built-in handles, double-ribbed base for increased stability and dragging capacity and seamless construction with rounded corners for easy cleaning
- Twist-on dolly for easy mobility
- Strong, snap-on lid keeps odours in
- Grey and white are USDA Meat and Poultry Equipment Group listed

Note: Items shown in caddy bag NC428 are not included.

Model No.	Mfg. No.	Description	Capacity US Gal.	Dimensions			Colour	Wt. lbs.		
				L"	x	W"	x	H"		
NC425†	3526	Brute® Container	28	21 1/2	x	21 1/2	x	22 1/2	Grey	10
NC426†	3526	Brute® Container	28	21 1/2	x	21 1/2	x	22 1/2	White	10
NA754	3527	Flat Lid	-	22	x	22	x	2	Grey	3
NA755†	3527	Flat Lid	-	22	x	22	x	2	White	3
NA758	3536	Brute® Container	40	23 1/2	x	23 1/2	x	28 3/4	Grey	15
NA762	3539	Flat Lid	-	24	x	24	x	2	Grey	4
NA763	3539	Flat Lid	-	24	x	24	x	2	White	4
NA757***	3530	Twist-On Dolly	-	17 1/4	x	17 1/4	x	6 1/4	Black	7
NC428*	2642	Brute® Caddy Bag	-	20	x	20	x	20 1/2	Yellow	2

* Fits 40 US gallon containers only. ** Weight Capacity: 250 lbs.

† Accepted for use in Canadian food processing facilities

NA754



NC425



NC428 Caddy Bag for 40-Gallon Container (Sold Separately)

WASTE CONTAINERS & DRUM TOPS

UNTOUCHABLE™ CONTAINERS

- Durable tough polyethylene construction, crack resistant and ideal for indoors or outdoors use
- Ideal for hotel lobbies, restrooms, shopping malls, restaurants and snack areas
- Optional swing top or flat top swings open freely
- ADA compliant, touch free

Model No.	Mfg. No.	Description	Capacity US Gal.	L" x W" x H"	Colour	Wt. lbs.
JB619	3569	Untouchable™ Container	23	16 1/2 x 15 1/2 x 31	Beige	7
JB620	3569	Untouchable™ Container	23	16 1/2 x 15 1/2 x 31	Grey	7
JB608	2689	Swing Top	-	16 x 16 x 4	Beige	3
JB607	2689	Swing Top	-	16 x 16 x 4	Black	3
NC432	3958	Untouchable™ Container	35	19 5/8 x 19 5/8 x 27 1/4	Beige	9
NC433	3958	Untouchable™ Container	35	19 5/8 x 19 5/8 x 27 1/4	Grey	9
NC434	3959	Untouchable™ Container	50	19 3/4 x 19 3/4 x 34	Beige	13
NC435	3959	Untouchable™ Container	50	19 3/4 x 19 3/4 x 34	Grey	13
NC436	2664	Swing Top	-	20 1/8 x 20 1/8 x 6 1/4	Beige	4
NC437	2664	Swing Top	-	20 1/8 x 20 1/8 x 6 1/4	Grey	4
NA751	3520	Untouchable™ Half Round Container	-	21 x 11 x 28	Beige	8
NA752	3520	Untouchable™ Half Round Container	-	21 x 11 x 28	Grey	8
NI551	3620	Half Round Lid	-	21 5/16 x 21 1/3 x 9 1/6	Black	3



MARSHALL™ CONTAINERS

- Under normal use (with top on and swing door shut) the container will restrain flames and extinguish them
- Optional grey rigid liner
- ADA compliant

Model No.	Mfg. No.	Capacity US Gal.	Dimensions Dia. x H"	Wt. lbs.
NH381	NH382	15	15 3/8 x 36 1/2	20
NH383	NH384	21	18 x 42	23

RIGID LINERS

Model No.	Mfg. No.	Capacity US Gal.	For Container	Dimensions Dia. x H"	Wt. lbs.
NA770	3550	12 1/8	15 US gal.	12 x 27 1/4	5
NA771	3552	22	21 US gal.	14 1/2 x 30 1/8	7



FIRE RESISTANT WASTEBASKETS

- Rounded corners add strength and durability; will not rust, chip or dent
- U.L. classified containers contain burning paper without the wastebasket melting or contributing fuel to the container's contents
- CSFM approved and UL listed



Model No.	Mfg. No.	Capacity Quarts	Dimensions L" x W" x H"	Wt. lbs.
NA676	NA677	14	11.2 x 8.3 x 12.3	5
NA678	NA679	28	14.5 x 10.5 x 15.3	6
NC438	-	40	15.0 x 11.3 x 20.0	8

ROUND TOP CONTAINERS

- A proven fire safe approach to indoor litter control without sacrificing appearance or performance
- Self-extinguishing design
- Self-closing stainless steel door snuffs out fires
- Durable Uni-Koat® powder coated finish
- Non-corrosive stainless steel base ring protects floors and carpets
- Galvanised liner makes emptying easy
- Complies with OSHA and ADA standards
- FM, CSFM approved and UL listed

NA889



Model No.	Capacity US Gal.	Dim. Dia. x H"	Wt. lbs.
White			
Black			
Almond			
Chrome			
NA889	12	15 x 30	22
NA890	15	15 x 36	26
-	15	15 x 36	26

RANGER™ CONTAINERS

- Seamless structural web construction will not rust, corrode and is easy to clean
- Metal bag straps provide a secure method of liner retention
- Optional pedestal base design for 45 gallons and up provides stability even in outdoor environments
- UL classified and FM approved on models with doors
- ADA compliant



JB531

Model No.	Mfg. No.	Description	Capacity US Gal.	Dimensions L" x W" x H"	Wt. lbs.
JB531	JB532	1 Door Top	35	21.5 x 21.5 x 41	30
JB534	-	2 Door Top	45	24.8 x 24.8 x 41.5	41
JB536	-	4 Openings	45	24.8 x 24.8 x 41.5	37
JB538	-	2 Door Top	65	24.8 x 24.8 x 49.25	50
JB540	-	4 Openings	65	24.8 x 24.8 x 49.25	60
JB542	-	Weighted Base	-	24.5 x 24.5 x 6	8.5

SELF-CLOSING DRUM TOPS

- Convert metal or plastic drums into safe waste containers
- Self-closing push door controls odours
- Thumb screws for fastening
- FM approved when used with a steel drum

Drums Not Included



Model No.	Colour	Diameter"	Wt. lbs.
NA669	Green	24 1/2	12
NA670	Red	24 1/2	12
NH720	Black	24 1/2	12
NA672	Green	20	9

WASTE CONTAINERS

GALVANISED GARBAGE CANS

- Uniform thickness throughout, no rough spots or barbs
- Handles are riveted in place for maximum strength
- Standard garbage cans are manufactured of pre-galvanised steel and come with plain covers
- Heavy-duty cans are manufactured of pre-galvanised steel with a heavier zinc coating for greater durability
- Covers are spring lock type with soldered seams, and 16-gauge steel reinforcing bands on the bottom
- Smooth, bright, rust proof finish
- **NG311** comes with plain cover



Model No.	Capacity Gal.	Top Dia."	Bottom Dia."	O.A. Height"	Gauge	Wt. lbs.
-----------	---------------	-----------	--------------	--------------	-------	----------

STANDARD CANS

NG307	11	15	13 3/4	18	30	6.5
NG309	16 1/2	17	15	26 3/4	30	9
NG310	20	17	15	30 3/4	30	9.5

HEAVY-DUTY CANS

NG311	11	15	13 3/4	18	28	8
NG312	16 1/2	17	15	27 1/4	26	12.5
NG313	20	17	15	31	26	13

PRE-GALVANISED STEEL GARBAGE CANS

- Manufactured from 30-gauge pre-galvanised steel
- Top is 3/16" wire rolled
- Bottom is deeply formed for extra strength, raised 5/8" for longer life and handling ease
- Handles are smooth edged and riveted
- Single handled self-locking cover (included) is deeply formed and has reinforcing ribs for extra strength
- Smooth, bright, rust proof finish



Model No.	Capacity Gal.	Dimensions Dia." x H"	Wt. lbs.
-----------	---------------	-----------------------	----------

NG314	14	17 x 23	8
NG315	16 1/2	17 x 26 3/4	8.5

BRUTE® ROLL OUT CONTAINERS

- Containers are made of durable polyethylene that will not chip, crack or peel
- Hinged lids remains attached and locked for efficient handling
- One-piece body construction provides superior durability and strength

50 US GALLON

- Molded-in axle retainer adds strength
- New in-mold catch bar is compatible with semi-automated lift systems
- Heavy-duty, 8" wheels allow for easy mobility, even over steps and curbs

65 & 95 US GALLON

- Steel catch bar is compatible with semi-automated lift systems
- Molded-in foot tilters helps manoeuvre heavy loads



Model No.	Mfg. No.	Dimensions L" x W" x H"	Capacity US Gal.	Colour	Wt. lbs.
-----------	----------	-------------------------	------------------	--------	----------

NI825	9W27	29 x 23.5 x 36.75	50	Grey	27.13
NI824	9W27	29 x 23.5 x 36.75	50	Blue	27.13
NI485	9W21	25 x 32.3 x 41.8	65	Grey	25.6
NI486	9W22	36 x 27.3 x 45.6	95	Grey	36
NI487	9W22	36 x 27.3 x 45.6	95	Blue	36

SLIM JIM® WALL MOUNTED CONTAINERS

- Wall-mounting this unit maximises off-the-floor space and allows for floor cleaning
- Duramold® construction resists denting, chipping and peeling
- Dimensions: 19 1/2" L x 11 7/8" W x 32 5/8" H
- FM approved for fire safety when wall mounted
- Capacity: 15 US gallons
- Weight: 12 lbs.
- ADA compliant



NA817



Model No.	MFG No.	Colour
-----------	---------	--------

NA817	7822-00	Beige
JD954	1829401	Blue

BRUTE® STEP-ON ROLLOUT CONTAINER WITH CASTERS

- Smooth contours and seamless construction make cleaning easier and quicker, to improve staff productivity
- Designed with an ergonomic handle for comfortable push or pull operation
- Facilitate hands-free waste disposal with the added benefit of superior mobility
- Heavy-duty wheels with high-performance treads are optimized for use indoors and outdoors
- Reinforced rim for superior structural integrity and robust lid designed for added strength
- Lids open fully and stay in place to prevent swinging during transport
- Compliant with ANSI Standard Z245.60 (Types B and G) for compatibility with auto-lifters
- Swivel casters at the front of the container distribute weight evenly and allow for more controlled use
- Material: Polyethylene



Model No.	Mfg. No.	Dimensions L" x W" x H"	Capacity Colour	US Gal.
-----------	----------	-------------------------	-----------------	---------

WITH SWIVEL CASTERS

JH471	1971950	28.6 x 20.7 x 37.2	Gray	32
JH490	1971952	28.6 x 20.7 x 37.2	Blue	32
JH493	1971962	30.1 x 24 x 39.6	Gray	50
JH494	1971964	30.1 x 24 x 39.6	Blue	50
JH495	1971974	32.3 x 25.3 x 44.7	Gray	65
JH497	1971976	32.3 x 25.3 x 44.7	Blue	65
JH499	1971997	37.2 x 28.6 x 46	Gray	95
JH420	1971999	37.2 x 28.6 x 46	Blue	95

WITHOUT SWIVEL CASTERS

JH421	1971944	28.6 x 20.7 x 37.2	Gray	32
JH422	1971946	28.6 x 20.7 x 37.2	Blue	32
JH423	1971956	30.1 x 24 x 39.6	Gray	50
JH434	1971958	30.1 x 24 x 39.6	Blue	50
JH446	1971968	32.3 x 25.3 x 44.7	Gray	65
JH447	1971970	32.3 x 25.3 x 44.7	Blue	65
JH448	1971991	37.2 x 28.6 x 46	Gray	95
JH449	1971993	37.2 x 28.6 x 46	Blue	95

ROLLABLE CONTAINER

- Durable polyethylene construction is resistant to chipping and peeling
- Easy to grip handles
- Wheels allow for the efficient movement of heavy contents
- Material: Polyethylene



Model No.	Capacity US Gal.	Colour
-----------	------------------	--------

JH478	65	Blue
JH479	65	Grey



MOP BUCKETS & WRINGERS

MOP BUCKET

- Handles and wide rounded spout facilitate emptying
- Visible caution sign on side of bucket
- 3" casters for easy mobility



Model No.	Colour	Capacity
JG812	Yellow	9.5 US Gal. (38 Quart)

MOP BUCKET WRINGER

- Wringer reduces splashing for a safer and cleaner work environment
- Ideal for mops up to 32 oz.
- Ergonomic handle allows for effortless operation
- Colour: Yellow



Model No.	Wringer Type
JG809	Side Press
JG810	Down Press

MOP BUCKET & WRINGER COMBO PACKS

- Choose any of these conveniently combined buckets and wringers
- NC493 shown with dirty water bucket (NI869)



Model No.	Mfg. No.	Combo Pack		Colour	Wt. lbs.
		Bucket	Wringer		
NC493	7580-88-YEL	NI863 Brute®	NI871 Sideward	Yellow	17.5
NC492	7580-88-BR	NI864 Brute®	NI870 Sideward	Brown	17.5
NG965	7588-88-RD	NI865 Brute®	NI872 Sideward	Red	17.5
NG966	7588-88-GR	NI866 Brute®	NI873 Sideward	Green	17.5
NG967	7588-88-BL	NI867 Brute®	NI874 Sideward	Blue	17.5
NI828	7577-88-YEL	NI863 Brute®	NI908 Downward	Yellow	22
JA958	7577-88-BR	NI864 Brute®	NI907 Downward	Brown	22

MOP BUCKETS

- Constructed of plastic, which resists denting, chipping and peeling
- WaveBreak™ design, reduces wave motion when moving buckets, resulting in less spilling and splashing
- Large pour spout and handles designed to make emptying easy
- Contoured graduation markings
- Built-in mop handle clip, reduces damage to walls caused by flopping mop handles
- Buckets are nestable, ideal for small janitorial closets
- Optional dirty water bucket available in red and yellow only, prevents dirty water from mixing with clean water
- 3" non-marking casters are recessed under the bucket
- Dimensions: 20.1" L x 16" W x 17.4" H
- Capacity: 35 US qt.
- Weight: 9.1 lbs.



Model No.	Mfg. No.	Colour
NI863	7570-88	Yellow
NI864	7570-88	Brown
NI865	7570-88	Red
NI867	7570-88	Blue

OPTIONAL DIRTY WATER BUCKETS

NI868	9C74	Yellow
NI869	9C74	Red

MOP BUCKET & WRINGER COMBO PACKS

- Wringer and bucket setup reduces splashing for a safer and cleaner work environment
- Built to accommodate heavy use
- Handles and wide rounded spout facilitate emptying
- Compatible with cleaning carts
- Removable casters
- Visible caution signs on sides of bucket
- Colour: Yellow
- Bucket Capacity: 9.5 US Gal. (38 Quart)



Model No.	Wringer Type
JG952	Down Press
JG811	Side Press



MOP BUCKET & WRINGER COMBO PACKS

- WaveBrake™ design bucket reduces splashing and spilling
- Ergonomic handle
- 3" recessed non-marking casters
- 35-qt. bucket
- Includes: Dirty water bucket, which prevents dirty water from mixing with clean water

Model No. NI899 Side press
Model No. JA981 Down press



44-QUART MOP BUCKET & WRINGER COMBO PACKS

- WaveBreak™ innovative bucket design reduces splashing by 40%
- 44-qt. capacity for the largest of commercial cleaning jobs
- Durable wringer lasts up to 50 000 wrings
- Foot-activated pedal allows for easy emptying of bucket
- Dirty water bucket optional NI868 and NI869
- Cleaning cart compatible

Model No. JB614 Side press
Mfg. No. 6186-88
Model No. JB615 Down press
Mfg. No. 7576-88



MOP WRINGERS

- Constructed for heavy use with effortless operation
- Wringer directs water downward into buckets to help reduce splashing
- Improved wringer design, features an ergonomic handle and generates 25% more force
- Sideward pressure wringers are ideal for 12-32 oz. mops
- Downward pressure wringers accommodates all mop heads and is ideal for heavy-duty use



Model No.	Mfg. No.	Press Style	Capacity oz.	Colour	Wt. lbs.
NI870	6127-88	Sideward	12-32	Brown	8.4
NI871	6127-88	Sideward	12-32	Yellow	8.4
NI872	6127-88	Sideward	12-32	Red	8.4
NI873	6127-88	Sideward	12-32	Green	8.4
NI874	6127-88	Sideward	12-32	Blue	8.4
NI907	7575-88	Downward	16-32	Brown	11
NI908	7575-88	Downward	16-32	Yellow	11

WET MOPS & ACCESSORIES

WIPING RAGS

- Disposable cloth wiping rags cannot be beat for their absorbency, durability, versatility and low price
- Made from 100% recycled materials
- Choose new or recycled rags
- Packaged in compressed poly bags:
 - Compact – 50% reduction
 - Save money on transport and storage
 - Waterproof
 - Stackable and easy to handle



JB447

Model No.	Description	Weight lbs.
FLEECE		
JB446	Recycled Coloured Fleece	10
JB447	Recycled Coloured Fleece	25
JD398	Recycled Grey Fleece	10
JD399	Recycled Grey Fleece	25
T-SHIRT		
JB442	Recycled Coloured T-Shirt	10
JB443	Recycled Coloured T-Shirt	25
JB450	Recycled White T-Shirt	10
JB451	Recycled White T-Shirt	25

Model No.	Description	Weight lbs.
NEW JERSEY		
JD573	New White Jersey	20
JD574	New White Jersey	10
JD571	New Coloured Jersey	25
JD572	New Coloured Jersey	10

PORTABLE MOBILE BARRIERS

- Four locking straps to secure barrier in closed position
- Flexible, can be set straight, curved or in a circle
- Two 5" non-marking wheels
- For indoor use
- Easy to store
- Extended Length: 13'
- Height: 40"
- Colour: Yellow
- Material: Plastic

Model No. SAJ714



BILINGUAL SAFETY FLOOR SIGNS

- Durable polypropylene construction
- Bright yellow for maximum visibility
- Message in both English and French
- Stamped black lettering will not fade or peel
- 12" W x 24" H
- Weight: 2 lbs.

Model No. JD391



FLOOR SIGNS

- Highly visible yellow polypropylene floor signs are durable and non-corrosive
- Hot stamped lettering will not peel or fade
- Messages for Caution and Closed signs are printed in English, French, German and Spanish
- Message "Wet Floor" printed in English only
- Weight: 2 lbs.
- ANSI and OSHA compliant colour and graphics

Model No.	Mfg. No.	Message	Height"
NB790	6112	2-Sided Multi-Lingual Caution	25
NC527	6114	4-Sided Multi-Lingual Caution	37
NC528	6112-77	2-Sided Caution Wet Floor	25
NC529	6114-77	4-Sided Caution Wet Floor	37
NC530	6112-78	2-Sided Multi-Lingual Closed	25
NC531	6114-78	4-Sided Multi-Lingual Closed	37

NB790



PORTABLE MOBILE BARRIERS

- Swivel casters in front and 8" rear wheels allow for easy use
- 4 shelves and hooks keep appliances organized
- Ample storage capacity for all cleaning equipment
- Bag Colour: Yellow
- Bag Size: 14" x 10" x 31"
- Cart Material: Plastic
- Colour: Black
- Overall Height: 38"
- Overall Width: 20"
- Overall Length: 31"

Model No. JG813



BRUTE® BUCKETS

- Molded-in graduations for accurate measuring
- Thick top rim with spout permits neat pouring
- Tough construction resists cracking and provides great flexibility
- Sturdy zinc-plated handle resist rusting or bending
- Double compartment bucket carries both cleaning solution and rinse water for efficient area cleaning, can be used with steel roller sponge mop
- Grey



Model No.	Mfg. No.	Description	Dimensions	Cap. qt.
NB853	2963	Brute® Round Bucket	10 1/2" Dia. x 10 1/4" H	10
NB848	2614	Brute® Round Bucket	12" Dia. x 11 1/4" H	14
NB851	2617	Double Compartment Bucket	14 5/8" L x 13 7/8" W x 10 1/8" H	17

WET MOPS

- High grade cotton yarn is durable and absorbent with excellent floor drying qualities, increasing worker productivity and safety
- Cotton industrial narrow band wet mops are economical and great for general purpose cleaning
- High grade rayon yarn is the most absorbent fibre and it releases moisture quickly from the mop making this a good economical finish mop for applying waxes or finishers
- Good quality, fast drying poly head band
- Fan-foot construction allows for maximum floor coverage
- Use with any narrow band mop handle

JB760



Model No.	Mfg. No.	Description	Wt. oz./grams
COTTON			
JB668	1616	Cut End	16/450
JB669	1620	Cut End	20/550
JB670	1624	Cut End	24/650
JB671	1632	Cut End	32/850
RAYON			
JB752	4016	Cut End	16/450
JB753	4020	Cut End	20/550
JB754	4024	Cut End	24/650
JB755	4032	Cut End	32/850

HANDLES

Model No.	Description	Length"
JB722	Metal Head, Wood Handle	54
JB721	Plastic Head, Fibreglass Handle	54
JC509	Plastic Head, Fibreglass Handle	60
JB723	Plastic Head, Fibreglass Handle	60

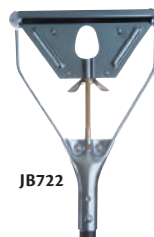

JB722



JB721



JB723

CLEANING CARTS

- Sturdy Duramold® construction
- Molded-in hooks and shelves are strategically placed to keep cleaning tools organized
- Swivel front casters and 8" rear wheels
- Includes: 25 US gallon yellow vinyl bag
- Dimensions: 46" L x 21 3/4" W x 38 3/8" H
- Cleaning tools not included
- Weight: 38 lbs.

Model No. JB599 Blue
Mfg. No. 6173-88

Model No. JB600 Black
Mfg. No. 6173-88



MULTI-PURPOSE CLEANER & DEGREASER

- Formulated to safely clean and deodorize all washable surfaces
- Biodegradable, non-toxic, non-corrosive
- Concentrated
- Contains natural tangerine essential oils
- Accepted for use in Canadian food processing facilities
- Certified UL ECOLOGO® 175
- 4 L • Case Qty: 4

Model No. JC001



MULTI-PURPOSE BATHROOM CLEANER

- Formulated to clean, shine and deodorize with a fresh scent
- Safely cleans soap scum and urine from floor, counters, sinks, showers and toilets
- Concentrated
- Biodegradable, non-toxic, non-corrosive
- Contains natural essential oils
- No acids or bleach
- Certified UL ECOLOGO® 175
- 4 L • Case Qty: 4

Model No. JC004



HEAVY-DUTY CLEANER & DEGREASER

- Super concentrated cleaning power for a variety of heavy-duty applications
- Biodegradable, non-toxic, non-corrosive
- Contains natural tangerine essential oils
- Dissolves grease, oil, inks, grime and tough stains on contact
- Accepted for use in Canadian food processing facilities
- Certified UL ECOLOGO® 175
- 4 L • Case Qty: 4

Model No. JC002



TANGERINE OIL NEUTRAL CLEANER

- Safely cleans all washable surfaces using a neutral pH concentrated formulation
- Biodegradable, non-toxic, non-corrosive
- Contains natural essential oils
- Concentrated
- No rinse formulation
- Accepted for use in Canadian food processing facilities
- Certified UL ECOLOGO® 175
- 4 L • Case Qty: 4

Model No. JC006



CLEANER & DEGREASER

PHOSPHATE-FREE HEAVY-DUTY DEGREASER & MULTI-PURPOSE CLEANER

- Concentrated, powerful, fast acting alkaline cleaner
- Removes stains, grime, oil, soot and grease on contact
- Biodegradable
- Accepted for use in Canadian food processing facilities
- 4 L • Case Qty: 4

Model No. JA148



NATURAL CITRUS BASED CLEANERS & DEGREASERS

- Concentrated, heavy-duty
- Biodegradable, phosphate-free, non-abrasive, non-butyl
- Accepted for use in Canadian food processing facilities
- 4 L • Case Qty: 4

Model No. JA465



LEMON-SCENTED MULTI-PURPOSE CLEANER/DEGREASER

- Concentrated
- Cleans, deodorizes and is safe to use on all washable surfaces
- Biodegradable, non-butyl
- 4 L • Case Qty: 4

Model No. JA147



WHITE PEARL HAND SOAP

- Rich blend of emollients leaves hands soft, fresh and clean
- Luxurious high quality concentrated lotion
- Pleasant almond scent
- Biodegradable, phosphate-free
- Accepted for use in Canadian food processing facilities
- 4 L • Case Qty: 4

Model No. NI347



NEUTRAL DETERGENT FLOOR CLEANER

- Concentrated neutral detergent specially formulated to clean any floor and add a brilliant shine to dull floors
- Cleans, brightens and deodorizes
- Low foaming, leaves pleasant citrus-orange scent, no rinsing required
- 4 L • Case Qty: 4

Model No. JA464



PINK LIQUID HAND SOAP

- Leaves hands smelling baby fresh, soft and clean
- Biodegradable, phosphate-free
- Accepted for use in Canadian food processing facilities
- 4 L • Case Qty: 4

Model No. NI343



TRIGGER BOTTLES & SPRAYERS

PLASTIC BOTTLES

- Blow-molded from high-density polyethylene
- Available in three sizes: 16 oz., 24 oz. and 32 oz.

Model No.	Description	Size	Dimensions		
			Size	Dia."	H"
NG655	Round Bottle with Graduations	24 oz.	3 1/8	x	8
NI424	Round Bottle with Graduations	32 oz.	3 1/8	x	9 7/8
NI412	Round Bottle with WHIMIS Label with Graduations	24 oz.	3 1/8	x	8

NG655



NI412



TRIGGER SPRAYERS

- All sprayers adjustable to provide fine mist to a steady stream
- Dip tubes available in two lengths and come equipped with filter screen

Model No.	Description
NJ166	Multi Purpose Sprayer 8" Dip Tube Red/White
NJ167	Large Multi-Purpose Sprayer 9" Dip Tube Blue/White

NJ166

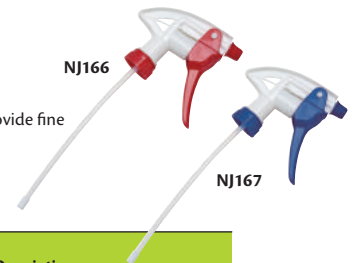

NJ167

BROOMS & HANDLES

PUSH BROOM DEGREES OF SWEEP

Push brooms are available in fine, medium, coarse, and extra-coarse.



JC215

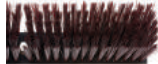

JC199



JC194

Model No.	Mfg. No.	Description	Fibre	Handle	Bloc Dim."
JC215	58118	Industrial Fine Sweep	Synthetic	Threaded	18
JC216	58124	Industrial Fine Sweep	Synthetic	Threaded	24
JC217	58126	Industrial Fine Sweep	Synthetic	Threaded	36
JC194	6318	Industrial Medium Sweep	Synthetic	Threaded	18
JC195	6324	Industrial Medium Sweep	Synthetic	Threaded	24
JC196	6336	Industrial Medium Sweep	Synthetic	Threaded	36
JC213	56018	Warehouse Medium Sweep	Natural Tampico and Synthetic	Threaded	18
JC214	56024	Warehouse Medium Sweep	Natural Tampico and Synthetic	Threaded	24
JC199	8318	Industrial Coarse Sweep	Synthetic	Threaded	18
JC200	8324	Industrial Coarse Sweep	Synthetic	Threaded	24
JC201	8336	Industrial Coarse Sweep	Synthetic	Threaded	36
JC197	7414	X-Coarse Street Sweep	Synthetic	Tapered	14

5/16" Dia. threaded handles: **JB698** (54") or **JB719** (60"), metal tip
 1 1/8" Dia. tapered handles: **JB718** (54") or **JB720** (60")

FLEXSWEEP® INDUSTRIAL BROOMS

- Ideal for high frequency industrial use on smooth indoor floor surfaces
- Patented Flexsweep® connector acts like a shock absorber to combat the shearing stresses that break handles
- Connector removes the requirement for a brace and also gives the broom a lower profile for getting around and under equipment
- Synthetic fibre is oil, solvent, and moisture resistant which adds to the durability of this broom
- Sold ready to assemble with an industrial quality, 1 1/8" diameter Flexsweep® handle



Model No.	Mfg. No.	Description	Length"
JC907	99966	Medium Sweep	18
JC908	99967	Medium Sweep	24
JC909	99971	Coarse Sweep	18
JC910	99972	Coarse Sweep	24

SWEEPING COMPOUND

- Ideal to clean and reduce airborne dust during sweeping
- Allows for easy removal of dust and dirt on sealed and unsealed wood, concrete and metal floors
- 100% biodegradable

Model No.	Mfg. No.	Size
JD521	52509	22 kg
JD570	52510	100 kg
JD227	52511	135 kg



JD521



JD570

LOBBY-PRO™ UPRIGHT DUST PAN SYSTEMS

- Durable all-plastic pail and yoke, reduces noise, resists corrosion
- Wear pads and wheels featured on all models
- Adjustable handle grip for enhanced user comfort (NH505 only)



Model No.	Mfg. No.	Description	Dimensions			
			L"	x	W"	x H"
NH386	2531	Upright Dust Pan	12 3/4	x	11 1/4	x 5
NH504	2532	Upright Dust Pan with Cover	12 3/4	x	11 1/4	x 5
NH505	2533	Deluxe Upright Dust Pan	12 3/4	x	11 1/4	x 5
JC185		Lobby Broom w/48" Handle				
JB653		Lobby Broom w/28" Handle				

BROOM HANDLES

JC857: Hardwood handle with connector for Flexsweep® broom.

JB716 and **JB715:** Non-conductive fiberglass handle with nylon tip.

JB717: Economy metal extension pole (up to 78") for painting, scrubbing windows or washing trucks.

JB655: Solid 1" diameter hardwood handles for all bolt-in brooms (Firefly™).

JB718 and **JB720:** Wood tapered handle.

JB698: Economy wood threaded handle.

JB719: Wood handles with metal tip for longer thread life.

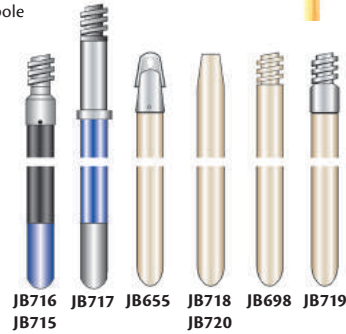

Model No.	Mfg. No.	Description	Dimensions		
			L"	x	Dia."
JC857	2538	Flexsweep® Handle and Connector	60	x	1 1/8
JB716	24511	Threaded Fibreglass - Blue	54	x	1
JB715	24510	Threaded Fibreglass - Blue	60	x	1
JB717	36778	2-Section Extension	78	x	1
JB655	2532	Jumbo Broom Wood	60	x	1
JB718	52506	Wooden Tapered	54	x	1 1/8
JB720	52513	Wooden Tapered	60	x	1 1/8
JB698	52504	Wooden Threaded	54	x	15/16
JB719	52510	Wooden Threaded - Metal Tip	60	x	15/16

CORN BROOMS

Corn brooms are available in medium and heavy service duty.

Medium: Multi-purpose indoor broom that is lightweight and used as a commercial corn broom for office buildings.

Heavy: Good outdoor industrial quality broom. The construction has more weight and reinforcement, and is designed for durability.



Model No.	Mfg. No.	Service Duty	Description
JB977	763	Medium	Janitorial, Corn & Grass
JB978	762	Heavy	Warehouse, All-Corn

SWEEP-N-SCAPE™ PUSH BROOMS

- Innovative metal scraper blade allows for easy removal of dried-on dirt or packed snow
- Long wearing PVC fibres are oil and solvent resistant
- Thick 1 1/8" hardwood handle and metal brace provide maximum strength and durability
- Perfect for driveways, sidewalks, patios, or garage floors



Model No.	Mfg. No.	Description	Length"
JB636	99824	X-Coarse/Scraper, Sweep-N-Scrape™	24

DUST PAN WITH BROOM

- Broom and pan connect to be stored as one
- Dust pan has wheels for easy maneuverability
- Material: Plastic

Model No. JH488



WASHROOM PRODUCTS

PERFORM™ STANDARD BATH TISSUE

- Made from 100% unbleached recycled fibre
- The most environmentally responsible choice on the market, by adding 20% corrugated box fibre into its pulp mix and eliminating bleaching chemicals
- Reduces the environmental impact of its raw material by 15%
- A revolutionary bathroom tissue, without compromising softness
- Can be used where septic tanks are installed and are biodegradable
- Available in standard, high capacity and jumbo rolls
- Third party certifications include Green Seal™, UL ECOLOGO® 175, and offset with 100% green-e® certified wind electricity



JH473



JD411

Cascades PRO

Perform



Model No.	Mfg. No.	Type	Ply	Sheet Size L x W	Sheets /Roll	Rolls /Case	Dispenser Option
JH473	B400	Standard	2	4.3" x 3.75"	400	80	JC095
JD405	T144	High-Capacity	2	3.9" x 4"	865	24	JC552, JC553, JD393, JG990
JD411	B500	Jumbo Roll	2	3.5" x 1000'	-	12	JC096, JC097
JF193	T263	Jumbo Roll	2	3.5" x 1400'	-	6	JC096, JC097

SELECT™ PAPER TOWEL ROLL

- Long-lasting rolls minimize maintenance costs while maximizing service
- Embossing enhances hand feel and maximizes absorbency; fewer towels are used per hand dry
- Made from 100% recycled fibres, with a minimum of 50% post-consumer material and are Green Seal Certified®
- Provide a level of quality that meets everyday needs
- A perfect combination of quality and value
- Fits on most universal dispensers and Cascade dispensers: **JC101, JC102, JC929**



Cascades PRO

Select

JC031



JC030



Model No.	Mfg. No.	Colour	Ply	Dimensions L' x W"	Rolls /Case	Dispenser Option
JH475	H225	Natural	1	205 x 7.5	24	JC101, JC102, JC929
JC030	H240	White	1	425 x 8	12	JC101, JC102, JC929
JC029	H245	Natural	1	425 x 8	12	JC101, JC102, JC929
JC055	H285	Natural	1	800 x 8	6	JC101, JC102, JC929
JC056	H280	White	1	800 x 8	6	JC101, JC102, JC929

HORIZONTAL BABY CHANGING STATIONS

- Meets all global safety standards (ASTM, ADA and EN)
- Antimicrobial protection
- Easy-reach hooks
- Built-in shelf and liner storage
- Made of FDA compliant materials
- Protective laminated 2-ply tissue paper liners are available (sold separately), 320 liners/carton



Model No.	Mfg. No.	Description	Dimensions L" x W" x H"				
JB910	7818	Changing table	33 1/4	x	21 1/2	x	4
NG454	7817	Liners 2-ply	13 1/2	x	5 1/2	x	N/A

SELECT™ BATH TISSUE STANDARD ROLLS

- Made entirely from 100% recycled fibres
- Combines softness, strength and sparkling whiteness at a competitive price
- Each roll is individually wrapped, ensuring sanitary protection
- Can be used where septic tanks are installed
- A great combination of strength, absorption, and value
- Certified UL ECOLOGO® 175 and Green Seal Certified®
- Colour: White
- Ply: 2



Cascades PRO

Select

JC017



JC018



Model No.	Mfg. No.	Roll Length'	Sheet Size L" x W"	Sheets /Roll	Rolls /Case	Dispenser Options
JC017	B160	139	4.2 x 3.8	420	48	JC095
JC018	B180	171	4.2 x 4.1	500	48	JC095

TUFF-JOB™ CENTRE-PULL WIPERS

- Centre pull wipers are easy to access and use
- Large capacity means fewer refills and lower maintenance costs
- Extra strong, low lint and absorbent
- Ideal for oil, grease, and solvents
- Superior absorbent material is ideal for all industrial, maintenance, and manufacturing applications
- Withstands any cleaning application
- 369 sheets/roll



Cascades PRO

Tuff-Job



JC038

Model No.	Mfg. No.	Colour	Ply	Size L' x W"	Rolls /Case	Dispenser Option
JC038	W601	White	1	13 x 8	6	JC034

TUFF-JOB™ HP WIPERS INTERFOLD POPUP

- Ideal replacements for rental shop towels or rags
- Excellent durability, strength, absorbency, and solvent resistance
- Perfect for heavy-duty machine & part wiping, applying solvents or thinners, adhesive cleaning, cable lubricant removal, tool clean-ups, and applying stains
- The ideal choice for applications that require resistance to solvents and virtually lint free wiping – applying aircraft solvents, wiping down print presses or plates and solvents for furniture stains

Cascades PRO

Tuff-Job



Model No.	Mfg. No.	Colour	Ply	Size L" x W"	Sheets /Box
JH470	W610	White	1	16.75 x 9.75	1JC037
JC037	W711	Blue	1	16.75 x 9.75	125

TUFF-JOB™ SCRIM WIPERS

- Ideal wiper for all-purpose wiping jobs where extra durability is needed and cost effective
- Low lint and good absorbency
- Perfect for general purpose wiping, surface and parts cleaning, wiping off solvents or chemicals, or the final wipe down of a product before packaging
- Multiple plies for more absorbency
- Superior wipe dry
- Polyester scrim webbing for extra strength and durability
- 100% recycled

Cascades PRO

Tuff-Job



Model No.	Mfg. No.	Colour	Ply	Size L" x W"	Sheets /Box
JC035	W202	White	4	16.75 x 9.75	150

HAND CLEANERS & DISPENSERS

ORANGE PUMICE HAND CLEANER

- Fresh, natural orange citrus scent
- Pumice scrubbing particles for extra deep cleaning
- Quick and easy removal of dirt, grease, paint, ink, epoxy, tar, rust and most industrial soils
- High quality pump included with every bottle for controlled dispensing
- Can conveniently be used with or without water
- No harsh solvents, leaving hands soft and clean
- Accepted for use in Canadian food processing facilities
- 3.6 L • Case Qty: 4

Model No. JG223



GOJO® NATURAL ORANGE™ HAND CLEANER

- Quick-acting lotion formula for cleaning a broad range of industrial soils, medium dirt and grease
- Citrus scent



Model No.	Mfg. No.	Description	Dispenser	Qty /Case
GOJO® NATURAL ORANGE™				
JA330	0947-12	14-oz. Bottle	-	12
JA329	0948-04	1/2 Gallon w/Pump	-	4
JA152	0945-04	1 Gallon w/Pump	-	4
JA373	7250-04	2000-ml Refill for PRO™ 2000	JA370	4
GOJO® NATURAL ORANGE™ W/PUMICE				
JA327	0957-12	14-oz. Bottle	-	12
JA328	0958-04	1/2 Gallon w/Pump	-	4
NI254	0955-04	1 Gallon w/Pump	-	4
JA374	7255-04	2000-ml Refill for PRO™ TDX™ 2000	JA370	4
JA382	7556-02	5000-ml Refill for PRO™ TDX™ 5000	JA379	2

CHERRY GEL®

- Gel-style heavy duty hand cleaner with pumice scrubbers quickly cleans heavy dirt, grease and oil
- Contains skin conditioners and is pH balanced to promote skin comfort
- Provides a quick, easy and complete rinse and leaves skin feeling refreshed
- Pleasant cherry fragrance eliminates soil odours and leaves hands smelling clean
- Starter kit SEA256 includes one dispenser and one refill



Model No.	Mfg. No.	Description	Dispenser	Qty /Case
SEA254	7590-02	5000-ml Refill	JA379	2
SEA255	7290-04	2000-ml Refill	JA370	4
SEA257	2350-02	50 x 0.5-fl. oz. in Display Carton	-	2
SEA258	2352-15	6-oz. Bottle	-	15
SEA259	2354-08	10-oz. Bottle	-	8
SEA260	2356-02	1/2 Gallon	-	2
SEA261	2358-02	1-Gallon Bottle	-	2

MICRELL® ANTIBACTERIAL LOTION SOAP

- Kills germs, yet is gentle on hands even after repeated daily washings
- Contains quick-acting antimicrobial agent chloroxylenol (PCMX) and an effective degreaser
- Lightly scented, non-irritating formula encourages frequent use
- Accepted for use in Canadian Food Processing Facilities



Model No.	Mfg. No.	Description	Dispenser	Qty /Case
JA367	9759-12-CAN00	12-oz. Pump Bottle	-	12
JA368	9755-04-CAN00	1 Gallon	-	4
JA366	2157-08-CAN00	1000-ml Refill	JA363	8
JA365	2257-04-CAN00	2000-ml Refill	-	4
DISPENSERS				REFILL
JA363	2125-06-CAN00	1000-ml Space Saver™	-	JA366

PURELL® HAND SANITIZERS

- America's #1 brand of instant hand sanitizer
- Kills 99.99% of most common germs that may cause illness
- Works in as little as 15 seconds
- No water or towels needed
- Contains a unique moisturizing system that leaves hands feeling soft (gentler to the hands than most soaps)
- Dermatologist tested, dye-free



Model No.	Mfg. No.	Description	Dispenser	Qty /Case
PURELL® HAND SANITIZERS				
JA357	2156-08-CAN00	1000-ml Refill for NXT® Dispenser	JA355	8
SAQ140	5456-04-CAN00	1200-ml Refill	SAQ139	4
PURELL® HAND SANITIZER WITH ALOE				
JA360	9674-12-CAN00	8-oz. (237 ml) Pump Bottle with Aloe	-	12
DISPENSERS				REFILL
JA355	2120-06-CAN00	Purell® 1000-ml NXT® Space Saver™	-	JA357
SAQ139	2720-06-CAN00	Purell® 1200-ml TFX® Touch Free Dispenser	-	SAQ140
JD983	9008-12	Holder for 12-oz. bottle	-	-

PURELL® HAND SANITIZER

- Purell® in a 70% ethyl alcohol, fragrance and dye free formulation
- Effective in destroying certain bacteria
- Contains vitamin E and glycerine



Model No.	Mfg. No.	Description	Dispenser	Qty /Case
SAR854	2770-08-CAN00	1000-ml NXT® Refill	JA355	8
SAR855	5770-04-CAN00	1200-ml Touchfree TFX™ Refill	SAQ139	4
SBA839	5795-04-CAN00	535-ml Foam Pump Bottle	-	4
SBA838	5395-02-CAN00	1200-ml Touchfree TFX™ Foam Refill	SAQ139	2
JA912	9650-24-CAN00	2-oz. (59 ml) Squeeze Bottle	-	24
JA722	9651-24-CAN00	4-oz. (118 ml) Bottle	-	24
JA358	9652-12-CAN00	8-oz. (237 ml) Pump Bottle	-	12
SAR856	3770-12-CAN00	12-oz. (354 ml) Bottle	-	12

INDUSTRIAL WET/DRY STAINLESS STEEL VACS

- 8 US-gallon stainless steel tank
- 5.5 peak HP motor
- 85 CFM air flow
- 72" sealed pressure
- Swivel casters provide easy movement in any direction
- Positive lock on hose eliminates unexpected disconnections
- 18' power cord
- **1 1/4" accessories include:** Flexible hose, extension wands, crevice tool, utility nozzle, floor brush, cartridge filter and dust bag

Model No. JCS25

aurora tools



INDUSTRIAL WET/DRY POLY VACUUM

- Tank Material: Polypropylene
- Motor Stage: Single
- Air Flow: 75 CFM
- Swivel casters provide easy movement in any direction
- Swivel casters provide easy movement in any direction
- 16' power cord
- **1-7/8" accessories include:** Flexible hose, extension wands, utility nozzle, crevice nozzle, floor brush, cartridge filter and dust bag

Model No. SDN116

aurora tools



INDUSTRIAL WET/DRY STAINLESS STEEL VACS

- 16 US-gallon stainless steel tank
- 6.5 peak HP motor
- 100 CFM air flow
- 80" sealed pressure
- Heavy-duty rear wheels with swivel front casters provide easy movement
- Removable steel handle
- Positive lock on hose eliminates unexpected disconnections
- Large accessory storage box attached
- 20' power cord
- **2 1/2" accessories include:** Flexible hose, extension wands, crevice tool, utility nozzle, floor brush, cartridge filter and dust bag

Model No. JCS28

aurora tools



INDUSTRIAL WET/DRY POLY VACUUM

- Motor Stage: Double
- Application: Wet Dry
- Air Flow: 100 CFM
- Peak HP: 6
- Tank Size: 12 gal.
- Tank Material: Polypropylene
- Swivel casters provide easy movement in any direction
- Positive lock on hose eliminates unexpected disconnects
- 16' power cord
- **1-7/8" accessories include:** Flexible hose, extension wands, utility nozzle, crevice nozzle, floor brush, cartridge filter and dust bag

Model No. SDN118

aurora tools



7" FLEXIBLE HOSE REPLACEMENT

Model No. JC834

ACCESSORIES & REPLACEMENT PARTS

Model No.	Description	Fits US Gallon Size
JCS31	Cartridge Filter	8 - 16 US gal.
JCS89	Hepa Cartridge Filter	8 - 16 US gal.
JCS88	Dust Collector Bag	8 US gal.
JCS89	Dust Collector Bag	10 - 12 US gal.
JCS91	Dust Collector Bag	16 US gal.
JCS34	Extension Wands	8 - 10 US gal.
JCS35	Utility Brush	8 - 10 US gal.
JCS36	6' Flexible Hose	8 - 10 US gal.
JCS37	Floor Brush	8 - 10 US gal.
JCS38	Crevice Tool	8 - 10 US gal.

INDUSTRIAL 18 US GAL. WET/DRY VAC 6.5 PEAK HP

- Large capacity wet/dry vac for the biggest cleaning needs
- 195 CFM
- 60" sealed pressure
- Features: 4-wheel dolly with transport handle, tool basket, tank drain, Lock-On® hose system, convertible blower port, cord wrap and 18' cord
- Some assembly required

Includes: 7-piece 1 1/2" accessory kit, high efficiency collector bag and ultra web cartridge filter

Model No. JD438



shop-vac

LARGE CAPACITY INDUSTRIAL WET/DRY VAC 6.5 PEAK HP

- Extra-large wet/dry vac for the largest cleaning jobs
- 195 CFM
- 60" sealed pressure
- Features: 4-wheel dolly with pneumatic rear wheels, transport handle, tool basket, tank drain, Lock-On® hose system, convertible blower port, cord wrap and 20' cord
- Also available in 24 US Gal. capacity, JD439
- Some assembly required

Includes: 7-piece 1 1/2" accessory kit and ultra web cartridge filter

Model No. JD439 24 US Gallons
Model No. JD440 32 US Gallons



shop-vac

JD440

INDUSTRIAL VACUUMS

LIGHTWEIGHT INDUSTRIAL DUTY WET/DRY VACUUMS 6.5 PEAK HP SINGLE STAGE MOTOR

- Single stage motor, wet/dry vacuum features blower port, Lock-On® hose system, quiet running motor, tool basket and tank drain
- Comes with a 4-wheel dolly
- Some assembly required

Includes: 1 1/4" 8-piece accessory package and filter kit



Model No.	Tank Cap. Gal/L	Tank Type	Peak HP	CFM	Electrical 120 V 60 Hz	Sealed Pressure"	Cord Length'	Wt. lbs.
NG332	8/37.8	Poly	6.5	185	9.7 A	66	18	19
NI142	8/36.3	Poly	6.5	185	9.7 A	66	18	27
NG333	8/37.8	Stainless	6.5	185	9.7 A	66	18	47



POWERFUL INDUSTRIAL WET/DRY VACUUMS, 2.5 PEAK HP, 2-STAGE MOTOR

- 2-stage quiet operation motor, wet/dry vacuums feature Lock-On® hose system, convertible blower port, double filtration system, tool basket and tank drain
- NI732 comes with an 11-piece 1 1/2" accessory package and filter kit
- NI730 comes with a 4-wheel dolly and 11-piece 1 1/2" accessory package and filter kit
- JG616 comes with a 4-wheel dolly and 13-piece 2 1/2" accessory package and filter kit



Model No.	Tank Cap. Gal/L	Tank Type	Peak HP	CFM	Electrical 120 V 60 Hz	Sealed Pressure"	Cord Length'	Wt. lbs.
NI732	10/45.5	Poly	2.5	100	9 A	90	35	32
NI730	8/37.8	Stainless	2.5	100	9 A	90	35	47
JG616	16/60.5	Poly	2.5	100	9.5 A	90	35	41



HEAVY-DUTY INDUSTRIAL VACUUMS, 3 PEAK HP, 2-STAGE MOTOR

- 2-stage motor, wet/dry vacuums feature Lock-On® hose system, blower port, double filtration system, tool basket
- 4-wheel dolly with non-marking wheels and tank drain

Includes: 1 1/2" 11-piece accessory package and filter kit with abrasive resistant HEPA cartridge filter



Model No.	Tank Cap. Gal/L	Tank Type	Peak HP	CFM	Electrical 120 V 60 Hz	Sealed Pressure"	Cord Length'	Wt. lbs.
JG614	10/37.8	Stainless	3.0	109	11A	105	35	51
NG337	20/75.7	Stainless	3.0	109	11 A	100	35	62



CONTRACTOR WET/DRY VACUUMS 6 & 6.5 HP SINGLE-STAGE MOTOR

CONTRACTOR VACUUMS

- Wet/dry vacuum with double filtration system
- Automatic float shutoff prevents wet pick up overflow
- 11.5-gallon stainless steel tank, convenient top and side carrying handles with a handy cord wrap
- Some assembly required

Includes: 1 1/2" accessory kit: 12' (3.66 m) flexible hose, two metal wands, 14" (35.56 cm) metal nozzle with detachable brush and squeegee, reusable dry filter (NG351), foam filter (NC252), disposable collector filter bag (NC238), rugged 3-wheel base with handle



INDUSTRIAL SR WET/DRY VACUUMS

- Multi-purpose vacuum with switch reluctance technology
- No motor brushes
- Up to 5000 hours of run time
- Rugged motor is warranted for 10 years
- Some assembly required

Includes: 2 1/2" 11-piece accessory kit and filter kit



Model No.	Tank Cap. Gal/L	Tank Type	Peak HP	CFM	Electrical 120 V 60 Hz	Sealed Pressure"	Cord Length'	Wt. lbs.
NI650	11.5/52.3	Stainless Steel	6.0	181	9.3 A	63	18	39
JC139	15/68	Poly	-	235	12 A	75	18	40



LIGHT CONTRACTOR WET/DRY VACUUMS – SINGLE STAGE MOTOR

CONTRACTOR/INDUSTRIAL 10 US GAL. WET/DRY VAC 6.5 PEAK HP

- Medium capacity stainless steel wet/dry vac is ideal for contractors and industrial applications
- Features: Stainless steel tank, 3-wheel dolly with transport handle, Lock-On® hose system, convertible blower port, cord wrap and top and side carry handles
- Also available in 15 US Gal. capacity – Model No. JD442 with metal accessories
- Some assembly required

Includes: 7-piece 1 1/2" accessory kit, high efficiency collector bag and ultra web cartridge filter

MEDIUM CAPACITY WET/DRY VACUUM 5 PEAK HP

- Medium capacity wet/dry vac for the toughest cleaning needs
- Features: Tool basket, tank drain, Lock-On® hose system, convertible blower port, cord wrap and top and side carry handles

Includes: 7-piece 1 1/2" accessory kit, high efficiency collector bag and ultra web cartridge filter

PORTABLE WET/DRY VACUUM 5.5 PEAK HP

- Portable and lightweight, this wet/dry vac is ideal for contractors and DIY
- Features: Lightweight portable design, Lock-On® hose system, convertible blower port, cord wrap and 20' cord

Includes: 3-piece 1 1/2" accessory kit, high efficiency collector bag and ultra web cartridge filter



JD441



JD434



JD436

Model No.	Tank Cap. Gal/L	Tank Type	Peak HP	CFM	Electrical 120 V 60 Hz	Sealed Pressure"	Cord Length'	Wt. lbs.
JD441	10/37.8	Stainless	6.5	195	12 A	60	18	36
JD442	15/56.8	Stainless	6.5	195	12 A	60	18	49
JD434	12/45.5	Poly	5	190	11.3 A	59	18	27
JD436	5/18.9	Poly	6	195	11.5 A	59	20	17



FACTORY INDUSTRIAL 44-GALLON DRUM VACUUMS

- 3.0 peak HP two-stage motor
- Large 44-gallon capacity and industrial head assembly built to handle the toughest jobs
- NG343 converts your steel drum into a wet/dry vacuum
- Heavy-duty dolly with NG342 only

Includes: 1 1/2" 4-piece accessory kit



NG343

NG342

SHOP SWEEPERS

- A time saving system for ridding large areas of litter
- 27" wide sweeping path cleans machine shops, factories, shipping and parking areas
- Does not require a motor or batteries to operate
- Can be used indoors/outdoors
- Lightweight structural foam frame has a large 1.4 cu. ft. capacity hopper
- Polypropylene main and side brooms adjust for different surfaces



NC099

Model No.	Tank Cap. Gal/L	Tank Type	Peak HP	CFM	Electrical 120 V 60 Hz	Sealed Pressure"	Cord Length'	Wt. lbs.
NG342	44/204.5	Metal	3	109	11 A	100	18	82
NG343	Head Assembly	N/A	3	109	11 A	100	-	30
NC099				Shop Sweeper				50



INDUSTRIAL VACUUMS

INDUSTRIAL PUMP VACUUMS, 6.5 PEAK HP MOTOR

- Industrial-duty pump vac can vacuum water quickly and easily
- 16-gallon (60.5L) poly tank empties itself using any standard garden hose (not included)
- Converts from wet/dry vac to pump-out operation
- Quiet vac pumps water up to heights of 50' (15m)
- Excellent for flooded basements, warehouses, hot tubs or spas

Includes: Both 1 1/4" 4-piece accessory kit and filter kit and 2 1/2" 8-piece accessory and filter kit



INDUSTRIAL WET/DRY VACUUMS, LONG LIFE MOTOR

- 2-Stage, long life motor
- 12-gallon stainless steel tank with drain
- 4-wheel dolly with transport handle
- Lock-On® hose system
- 5 years motor warranty

Includes: 7-piece 1 1/2" accessory and filter kit



Model No.	Tank Cap. US Gallons	Tank Type	Peak HP	CFM	Electrical 120V 60Hz	Sealed Pressure"	Cord Length'	Wt. lbs.
JG611	16/60.5	Poly	6.5	200	12 A	60	18	36
JG617	20/75.7	Poly	6.5	200	12 A	60	18	37
JG612	12/45.5	Stainless	2	100	8 A	80	18	36
JG618	14/53	Stainless	6.5	200	12 A	60	18	43

ACCESSORIES 1 1/2"

Model No.	Description	Model No.	Description
NC226	12' wands for overhead cleaning	NC219	14" metal master nozzle attachments required
NC218	51" chrome extension wands w/tool lock (2 pcs.)	NC220	14" squeegee shoe double blade
NC225	48" chrome extension wands fits NC218 only	NC221	14" rug shoe
NG626	Metal extension wand (2 pcs.)	NC222	14" brush shoe for dry floor cleaning
NC207*	15" crevice tool	NC277	Elbow joint 2 1/2"
NC228	Overhead pipe tool	NG627	Polypropylene master nozzle
NC242	3" metal round brush for irregular surfaces	NG628	Polypropylene squeegee
		NG629	Polypropylene carpet shoe

* Does not fit extension wands, to be used with hoses

ACCESSORIES 1 1/4"

Model No.	Description	Model No.	Description
JD449	Flexible crevice tool	NC264	Dual surface nozzle
JD450	Soft bristle brush	JD446	Wands (3-pieces)
JD451	Firm bristle brush	JD447	8' hose
NI903	Claw utility nozzle (fits all sizes)	JD448	Cleaning kit (3-pieces)

FILTERS & FILTER BAGS

Model No.	Description	Model No.	Description
NC196	Cloth filter bag. Fits all shop vacs	NG358*	High quality collector bags for 4 to 6.5 gal. (5 pkg.)
NG350	Collector bags for Brute® (3 pkg.)	NG359*	High quality collector bags for 8 to 11.5 gal. (5 pkg.)
NG351	Re-usable filters. Fits all shop vacs	NG360*	High quality collector bags for 12 to 17.5 gal. (5 pkg.)
NG352	Filter, polyester. Fits all shop vacs	NI530*	Cleanstream® filter, fits all wet/dry shop vacs
NC202	Collector bags for Hippo® (5 pkg.)	NI735	Ultra Web Cartridge Filter
NC217	Cartridge filter. Fits all shop vacs	NI736	Cleanstream® Abrasive resistant filter
NC236	Collector filter bags for 4 to 6.5 gal. (3 pkg.)		* 95% efficient @ 0.1 micron particle size
NC237	Collector filter bags for 12 to 17.5 gal. (3 pkg.)		
NC238	Collector filter bags for 8 to 11.5 gal. (3 pkg.)		
NC252	Foam filter sleeve, fits all wet/dry shop vacs		



HOSES

Model No.	Description	Size	Colour
NC215	w/Swivel end (crushproof)	1 1/2" x 25'	Black
NC223	Standard hose	1 1/4" x 18'	Black
NG363*	w/Threaded locking swivel	1 1/2" x 12"	Black
NG365	Standard hose	2 1/2" x 6'	Black
NG366	w/Curved wand	1 1/4" x 8'	Black
NC249	w/Swivel	1 1/2" x 12'	Black

* Current industrial commercial wet/dry vac only.

AIR MANAGEMENT SYSTEMS

AIR-MOVERS®

- Heavy-duty air mover is designed to quickly dry wet carpets and floors, with a second position for drying ceilings
- 3-speed air control
- Collapsible transport handle for easy storage



JC142

MIGHTY MINI™ SHOP VAC® AIR MOVER®

- Designed to quickly dry wet carpets and floors, with a second position for drying ceilings
- 3-speed air control
- Two power outlets
- Units are stackable for easy storage



JC846

PORTABLE AIR CIRCULATOR

- Shop ventilation and cooling, floor and carpet drying, smoke and odor evacuation, storm damage, large area ventilation
- 3 speed system
- Telescopic handle with integrated wheels



JG613

Model No.	Tank Cap Gal/L	Tank Type	Peak HP	CFM	Electrical 120 V 60 Hz	Sealed Pressure	Cord Length	Wt lbs.
JC142	N/A	Poly	N/A	1800	5 A	N/A	30	12
JC846	0.5	Poly	0.5	500	1.5 A	N/A	10	50
JG613	0.5	Stainless	0.5	3000	3.5 A	N/A	30	46

HEAVY-DUTY SALT/SAND STORAGE CONTAINER

The StorAll is a versatile container designed for year-round storage of salt/sand and utility storage. Its unique nesting design reduces storage space requirements and lowers the cost of transportation.

FEATURES:

- Thick-walled, durable polyethylene construction
- Double-walled reinforced lid
- Molded forklift pockets
- Knuckle and rod reinforced hinge design
- Weather resistant, corrosion free
- Ideal for schools, public works, parks and recreation, subways, bus terminals and any public/private walkway
- Stacks 10 per skid or 10 high in a trailer un-skidded
- Container Weight: 28 lbs.

ND202



ND337



Model No.	Colour	Dimensions			Capacity	
		L" x W" x H"	lbs.	cu. ft.		
ND337	Yellow	30 x 24 x 24	500	5.5		
ND202	Grey	30 x 24 x 24	500	5.5		

SOS™ SALT/SAND STORAGE BINS

FEATURES:

- Roto molded of LLDPE
- Impact resistant
- Double wall lockable lid
- Stands up to severe climate and weather conditions
- Lock not included
- 5-year warranty

Applications:

Salt or sand, pool or parking, ship or shore, dock or dugout, farm or factory, safety or security, cottage or construction, truck or trailer



NJ120



ND700



Model No.	Colour	Forklift Pockets	Dimensions			Capacity	
			L" x W" x H"	lbs.	cu. ft.		
ND700	Yellow	No	30 x 24 x 24	500	5.5		
ND701	Grey	No	30 x 24 x 24	500	5.5		
ND702	Yellow	Yes	42 x 29 x 30	1000	11		
ND703	Grey	Yes	42 x 29 x 30	1000	11		
NJ117	Yellow	Yes	48 x 33 x 34	1750	18.5		
NJ118	Grey	Yes	48 x 33 x 34	1750	18.5		
NJ119	Yellow	Yes	72 x 36 x 36	3500	36		
NJ120	Grey	Yes	72 x 36 x 36	3500	36		

NATURAL CHOICE™ ICE MELTERS

- Eco-friendly ice melter
- Natural Choice™ is an all-natural ice melter with an organic additive that improves its performance
- Natural Choice™ green marker assists in proper application to reduce environmental impact
- Natural Choice™ performance with ecology in mind
- This additive also acts as a corrosion inhibitor to reduce metal fatigue
- Melts down to -11° F / -24° C
- 44 lbs. or 20 kg

Model No. NJ140



FIRESTORM™ INTENSE ICE MELTERS

- Starts melting instantly - faster than most other ice melting products
- Prevents refreezing even under the most challenging conditions
- Safe for children and pets, will not burn skin, and gentle on vegetation
- Distinctive orange colour is easy to see, allowing you to use less while ensuring safety for pedestrians
- Magnesium chloride is less toxic than baking soda
- Melts down to -25° F / -32° C
- 44 lbs. or 20 kg

Model No. JB597



SALT SCOOP - 1 GALLON

- Molded with recycled plastics
- Ideal for salt, sand, farm/feed and more
- Colour: Black

Model No. NJ450



POLYETHYLENE SALT & SAND SCOOP

- Rotationally molded with 1/4" thickness for industrial strength
- Ideal for farm/feed, restaurant, salt and sand, compost/garden, industry
- Capacity: 1 gal.
- Colour: Yellow

Model No. PE095



MAINTENANCE EQUIPMENT & SUPPLIES

HEAVY-DUTY SHOVELS

- 12-gauge carbon steel blade
- Forward turned step for extra strength
- Ergonomic grip
- Welded fulcrum for added leverage

aurora tools®



Model No.	Description	Handle Type	Blade Size"	O.A. Length"
TLZ466	Round Point	D-Grip, Fibreglass	11 x 9	41
TLZ468	Square Point	D-Grip, Fibreglass	11 x 9	41

STANDARD-DUTY SHOVELS

- 14-gauge tempered steel blade
- Forward turned step for extra strength



aurora tools®

Model No.	Description	Handle Type	Blade Size"	O.A. Length"
NJ098	Square Point	Straight, Wood	8 7/8 x 11 1/2	60
NJ099	Round Point	Straight, Wood	8 7/8 x 11 1/2	60

INDUSTRIAL HOT WATER AQUAGUN®

- Heavy-duty, insulated, poly-clad zinc body
- For use with water temperatures up to 160°F (71°C)
- Solid brass stem and spray adjustment knob for long product life
- Stainless steel locking clip
- Threaded front, with protective cover, for accessory attachment



Model No. NE101
Mfg. No. 465C

melnor

HOT WATER RUBBER HOSES

- Rubber hose made with EPDM, optimized for hot water
- More kink-resistance and higher temperature ratings than vinyl hoses
- Octagonal brass crushproof couplings
- Max. operating temp. and pressure: 160°F at 100 PSI
- 10-year warranty

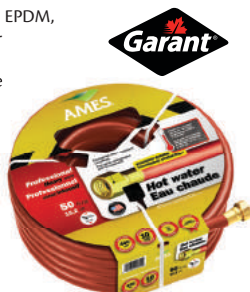

Model No.	Mfg. No.	Dimensions
NJ076	9960100	5/8" x 50'
NJ077	9960200	5/8" x 100'

HOSE HANGERS

- Poly hose hanger
- Capacity: 150' hose

Model No. ND038
Mfg. No. 23840



- Ribbed steel hose hanger
- Capacity: 150' hose

Model No. NE111
Mfg. No. 2383520



BROADCAST SPREADER

- Steel tube frame construction with chrome plated hardware
- Heavy-duty nylon gear box increases product life span
- Setting control on handle for precise adjustments
- Capacity 100 lbs.
- 12" x 4" pneumatic tires
- Blade size: 11" x 8 1/2"
- Overall length: 60"
- Coverage: 16000 sq. ft.
- Includes: rain cover and screen

Model No. NJ142



aurora tools®

WEED'N BUG ELIMINATOR® SPRAYERS

- 1.3, 2.0, 3.0-gallon capacity
- Translucent poly tank
- Poly pump with strong T-handle that stores spray wand
- Thumb-operated spray with on/off lock feature
- Thumb-operated poly spray wand with adjustable cone nozzle
- 33" no-kink Dura-Cril™ hose

1.3 Gallons
Model No. ND663
Mfg. No. 60151
2 Gallons
Model No. NJ086
Mfg. No. 60152
3 Gallons
Model No. ND665
Mfg. No. 60153



HUDSON

BRASS NOZZLE HAND SPRAYERS

- Chemical resistant poly bottle
- Adjustable brass nozzle for fine mist or straight stream
- Equipped with Viton® seals
- Capacity: 48 oz.

Model No. NJ164



aurora tools®

CONSTRUCTO® POLY SPRAYERS

- 2-gallon capacity
- Stable, six-footed translucent tank with large funnel top
- Metal Roto-Valve™ control valve rotates 360° for ergonomic comfort
- 18" curved brass spray wand
- TeeJet® nozzle tip
- Adjustable brass, flat fan pattern nozzle
- HPP™ high performance pump with easy carry metal D-handle and push rod
- Locking pressure release valve

Model No. NC057
Mfg. No. 90182



HUDSON

ELECTRIC PRESSURE WASHERS

MEDIUM-DUTY PROFESSIONAL

- 1.5 HP Baldor electric motor
- Increases garden hose power to 1000 PSI
- Integrated detergent feed system with adjustable unloader
- High-pressure hose
- 10" pneumatic wheels for easy manoeuvrability

Model No. TEB605
Mfg. No. KC2100EPC
Cleaning Units 2310
Pump Pressure 1000 PSI
Flow Rate 2.1 GPM
Hose Length 30'
Gun/Lance 115 cm
Electric Requirement 120 V, 15 A
Cord Length 23'
Dimensions 23 1/2" x 32 1/2" x 27"
Shipping Weight 95 lbs.



KODIAK
POWER EQUIPMENT

INFINITY™ SMOKING MANAGEMENT SOLUTIONS

- Sophisticated styling and all-metal construction for attractive and efficient smoking litter management
- High-capacity receptacles for heavy traffic areas
- Stainless steel snuff plate minimizes smoldering
- Integrated padlock tabs provide security against tampering and theft
- Weighted bases and bolt-down options for added stability outdoors
- 360° disposal area with domed tops for weather resistance
- Unobstructed funnels to reduce jamming during cigarette disposal



Model No.	Mfg. No.	Description	Diameter"	Height"	Capacity gal.	Colour
JB476	9W31	Base Mount	15.5	39	1.33	Black
JB477	9W32	Wall Mount	11.6	18	0.60	Black
JB478	9W33	Traditional	13	39.1	4.13	Black
JB480	9W33	Traditional	13	39.1	4.13	Pewter
JB481	9W33	Traditional	13	39.1	4.13	Bronze
JB479	9W34	High Capacity	15.4	39.8	6.7	Black
JB482	9W34	High Capacity	15.4	39.8	6.7	Pewter
JB483	9W34	High Capacity	15.4	39.8	6.7	Bronze



HEAVY-DUTY BUTT CANS

- Rugged heavy-duty fire safe galvanized steel base and neck tube finished in a tough powder coated red paint
- Polyethylene topper with molded-in graphics for cigarette butt disposal
- Self-extinguishing design offers maximum convenience and reduces the risk of fire



Model No.	Mfg. No.	Dim. Dia." x H"	Capacity US Gal	Wt. lbs.
JB906	26810R	11 1/2 x 34	2.5	9.6
JB907	26811R	11 1/2 x 38 1/2	5	10.5

GROUNDKEEPER™ CIGARETTE WASTE COLLECTORS

- Restricted opening shields cigarette butts from view, weather and reduces oxygen flow quickly extinguishing cigarettes
- Galvanized steel canister securely holds large quantities of cigarette waste
- 2-piece design makes cleaning quick and easy
- Flame-retardant injection-molded plastic will not rust or fade
- Factory Mutual and CSFM approved for fire safety
- Steel base plate adds weight for stability and discourages theft
- Dimensions: 12 1/4" L x 12 1/4" W x 39 3/4" H



Model No. NI553
Mfg. No. 2570-88



GROUNDKEEPER TUSCAN™ CIGARETTE WASTE COLLECTORS

- Column-style design
- Molded-in-colour polymer body with UV inhibitors, will not fade, chip, or rust
- Powder-coated aluminum cap will not burn or melt
- Galvanized steel ash canister
- Heavy steel base plate, will not fall over under windy conditions or if bumped
- Fastener and cable security kit available, NI688
- Dim.: 13" L x 13" W x 38 1/2" H
- Weight: 12.6 lbs.



Model No. NI686 Black
Mfg. No. 9W3000
Model No. NI687 Sand stone
Mfg. No. 9W3000

FASTENER & CABLE SECURITY KITS

Model No. NI688
Mfg. No. 9W2900



EXTERIOR SMOKING RECEPTACLES

- Heavy-duty 18-gauge brushed stainless steel
- Unique lid design protects unit in all weather conditions, eliminating messy clean-ups (NI753 only)
- Corrosion-resistant galvanized steel (22 ga) inner liner
- Tumbler keyed lock secures door
- Dimensions: 7" L x 3" W x 9" H
- Liner capacity: 1 L



NI753

Model No.	Description	Wt. lbs.
NI753	Ashtray with Cover	5
NI746	Ashtray without Cover	4
NI749	Lock and Key Replacement Kit	-
NI756	Replacement Inner Liner	-

EXTERIOR SMOKING RECEPTACLES

- Heavy-duty 18-gauge brushed stainless steel
- Unique lid design on NI743 protects unit from all weather conditions, eliminating messy clean-ups
- Corrosion-resistant galvanized steel (22 ga) inner liner
- Tumbler keyed lock secures door
- Dimensions: 9" L x 5" W x 13 1/2" H
- Liner capacity: 3.3 L
- Optional all-welded construction pedestal allows for floor mounting



NI752

Model No.	Description	Wt. lbs.
NI752	Ashtray	11
NI743	Ashtray with Cover	11
NI744	Heavy-Duty Pedestal	18
NI749	Lock and Key Replacement Kit	-
NI755	Replacement Inner Liner	-



ASHTRAYS & FANS

SMOKERS CEASE-FIRE®

- Innovative design limits the flow of oxygen to safely and quickly extinguish cigarettes and reduce the risk of fire
- Low maintenance, high-density polyethylene construction with a flame retardant additive
- UV protection, will not rust, dent, crack or peel - no more unsightly rust rings
- Molded-in graphics clearly identify unit for cigarette butt disposal
- Complete with large 16-qt. (15 L) capacity galvanized steel liner pail for easy cleaning excluding Personal Smokers Cease-Fire®
- FM approved



Pewter Grey		Model No.		Dimensions		Capacity	Wt.
		Adobe Beige	Deco Black	Mfg. No.	Description	US Gallons	lbs.
NH832		NI378	NI694	26800	Original Smokers Cease-Fire®	16 1/2 x 38 1/2	4 12
NI701		NI702	NI703	26806	Personal Smokers Cease-Fire®	11 x 30	1 6

CEASE-FIRE® ASHTRAYS

- Specially designed contoured head directs smoke and gas from any fire inside the container back into the combustion area
- Air supply is limited and flames are extinguished in seconds
- Drum bodies made of heavy gauge steel with a grey enamel exterior and a rust preventive interior coating
- FM approved, corrosion-free aluminum heads provide easy clean-up and can be used with standard steel drums
- Aluminum heads are also available separately for use with existing metal drums



NC449

Model No.	Mfg. No.	Capacity US Gal.	Dimensions Dia." x H"		Opening Dia."	Wt. lbs.
NC444	26604	4.5	11 7/8	x 14 1/4	5	6
NC445	26606	6	11 3/4	x 17 3/4	5	6
NC446	26612	12	14 1/2	x 23	5 1/4	10
NC447	26615	15	14 1/2	x 27 3/4	5 1/4	12
NC448	26630	30	19 1/4	x 31 3/4	7	28
NC449*	26655	55	23 3/4	x 38 1/2	7 7/8	35

*Drum should be filled 3/4 full only.

REPLACEMENT HEADS

Model No.	Description
NI416	Aluminum Head for 4.5 and 6-Gallon Receptacles
NI417	Aluminum Head for 12 and 15-Gallon Receptacles
NI418	Aluminum Head for 30-Gallon Receptacles
NI419	Aluminum Head for 55-Gallon Receptacles

HEAVY-DUTY OSCILLATING FANS

PEDESTAL

- All-metal construction, chrome grill and base painted black
- Can be used in oscillating or non-oscillating mode
- Adjustable height and heavy-duty round base for added stability
- 9.8' SJT power cord
- Base Dia. Cm: 69.3



EA666

WALL MOUNTED

- All-metal construction
- Fully enclosed motor

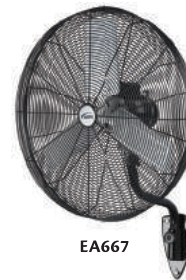

EA667



Model No.	Description	HP	No of Speeds	CFM Max.
EA666	30" Pedestal	1/3	3	13 200
EA667	30" Wall Mount	1/3	3	13 400

LIGHT INDUSTRIAL-DUTY AIR CIRCULATING FANS

- All-metal construction
- Fully enclosed 2-speed motor
- 6' SJT power cord
- Stem length for pedestal: 89-124 cm



EA284

EA282



Model No.	Description	HP	Voltage	CFM	
				Max.	Min.
OSCILLATING					
EA282	26" Pedestal	1/4	120	7525	4050
EA283	30" Pedestal	1/3	120	8778	6780
EA284	26" Wall Mount	1/4	120	7525	4050
EA654	30" Wall Mount	1/3	120	8775	6780
NON-OSCILLATING					
EA657	26" Pedestal	1/4	120	7700	6060
EA571	30" Pedestal	1/3	120	8000	7000
EA655	26" Wall Mount	1/4	120	7700	6060
EA656	30" Wall Mount	1/3	120	8000	7000

INDUSTRIAL-DUTY AIR CIRCULATING FANS

- All-metal construction
- 9.8' SJT power cord
- Stem length for pedestal: 89-124 cm



EA646



Model No.	Description	HP	Voltage	CFM		No. of Speeds
				Max.	Min.	
OSCILLATING						
EA645	24" Wall Mount	1/3	120	11 500	7680	2
EA649	30" Wall Mount	1/4	120	10 780	7760	2
EA643*	24" Pedestal	1/4	120	11 800	7760	2
EA647*	30" Pedestal	1/3	120	13 200	6700	2
NON-OSCILLATING						
EA644	24" Wall Mount	1/4	120	11 500	7680	2
EA648	30" Wall Mount	1/4	120	10 780	7440	2
EA642*	24" Pedestal	1/4	120	11 800	7760	2
EA646*	30" Pedestal	1/4	120	10 780	7440	2

*Features adjustable height and a heavy-duty round base for added stability

20" HIGH VELOCITY PEDESTAL FANS

- Rugged all-metal construction
- 1/4 HP, 120 V, 60 Hz, 150 W, 3-speed motor
- CFM: 5950 (high), 4550 (med), 3850 (low)
- Adjustable pedestal base
- 6' grounded power cord
- Weight: 36 lbs.
- 1-year warranty

Model No. EA289



LIGHT INDUSTRIAL DIRECT DRIVE DRUM FANS

- 120 V/60 Hz, 2-speed motor
- All-metal construction, painted black
- 6' SJT power cord
- 6" casters with easy moving handle
- 1-year warranty



Model No.	Blade"	HP	Watts	CFM		Wt. lbs.
				High	Low	
EA286	28	2/5	290	8050	6500	22
EA288	36	3/5	405	11 200	9100	30.5

24" ROLL-ABOUT FANS

- 120 V, 1/5 HP, 3-speed motor
- Cart mounted fan for increased air circulation and optimal mobility
- Can be tilted/ positioned to maximize ventilation
- Cart and frame configuration provide stable quiet operation
- CFM: 8550 (high), 7770 (medium) 7040 (low)
- 1-year warranty

Model No. EA476



HEAVY-DUTY FIXED BELT DRIVE DRUM FAN

- Fully enclosed motor
- All-metal construction
- 12' power cord
- Size: 42"
- No. of Speeds: 2
- HP: 3/4
- Max. CFM: 20945

Model No. EA662



HIGH-VELOCITY OSCILLATING WALL FAN

- Adjustable tilting fan head
- Sliding switch at front of base
- Rotating or fixed air direction
- Type: Wall Mounted
- Size: 20"
- No. of Speeds: 3

Model No. EA660



OFFICE FANS

- Light-duty, best suited for office environments



Model No	Description
EA304	6" Clip-on/Desk, 2-speed
EA305	12" Desk Oscilating, 3-speed
EA306	16" Desk Oscilating, 3-speed
EA526	16" Wall Oscilating, 3-speed
EA658	16" Pedestal Oscilating, 3-speed
EA551	18" Pedestal Oscilating, 3-speed

EA526



EA305



EA551



Convertible desk clip feature

20" BOX FANS

- 3-speed control
- Five slim blades
- Fully assembled and ready to use
- Weight: 9.92 lbs.

Model No. EA527



HIGH VELOCITY FLOOR FANS

- 120 V/60 Hz, 1/4 HP, 3-speed motor
- All-metal construction, chrome grill and base
- CFM: 4725 (high), 3850 (med), 2975 (low)



Model No.	Dia."	Wt. lbs.
EA528	16	10
EA290	18	16.18

EA290



HIGH VELOCITY FLOOR FAN

- All-metal construction
- Vertical pivot fan head
- Copper motor for longer lifetime
- Size: 20"
- No. of Speeds: 3
- HP: 0.2

Model No. EA661



FANS

CEILING FANS

- A major source of untapped energy is available at the ceiling in most industrial and commercial buildings
- Air stratification causes heat build-up at the ceiling as much as 25 °F or more above floor level temperatures
- By installing ceiling fans, this warm air can be recirculated down to floor level to maintain a uniform air temperature from floor to ceiling
- The result saving can be as much as 30%
- When ceiling fans are used for cooling people during the summer, they should be spaced 15' to 20' apart in the occupied area
- In warehouse storage areas, best results will be obtained if fans are mounted over aisle ways
- Fans should not be mounted less than 10' above the floor, the use of a safety cable is required on all ceiling fans

MARK I

- 1-year commercial warranty

MARK VI

- 2-year commercial warranty

JETPROOF

- Moisture and dust resistant
- Preassembled with watertight power cord and safety cable
- 2-year commercial warranty

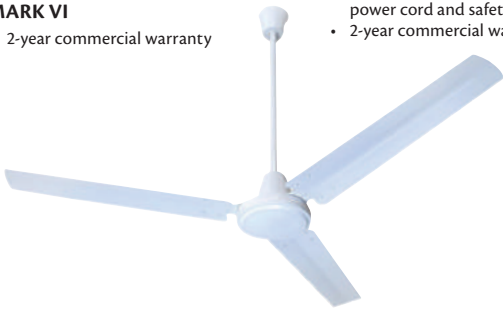

Model No.	Blade"	Fan Style	Down Length"	CFM	RPM	Voltage	Amps	Watts Full Speed	Wt. lbs.
EA357	56	Mark I	30/15	26400	290	120	0.52	62	15
EA358	56	Mark VI	32/14	32900	311	120	1.12	120	17
EA362	56	Jetproof (JP-CP)	24	32900	311	115	1.12	120	16

Note: Safety cable included. Cord and plug not provided, must be hard wired, wiring must conform to all national, state and local code (except EA362).

ACCESSORIES

Model No.	Description	Wt. lbs.
CONTROLS FOR CEILING FANS		
EA363	Variable speed control regulates 1 to 6 fans. Not to exceed a maximum amp draw of 6 amps	1
EA364	Variable speed control regulates 7 to 12 fans. Not to exceed a maximum amp draw of 10 amps	1
EA365	Variable speed control, 277 V, regulates 1 to 3 fans. 1.5 Amps	1
GUARD KIT & MESH COVER FOR 56" FANS		
EA366	61" Dia. nickel chrome-plated top and bottom protective guard kit	21

SHUTTER FANS

- 115 V motor 1-phase
- Totally enclosed motor
- Direct drive, low pressure
- Fully assembled, ready to install
- 24" and 30": 3 speeds with pull chain motor, plug and cord included
- Rear guard meets OSHA standards



Model No.	Fan Dia."	HP	0" S.P. CFM	1/8" S.P. CFM	A"	B"	F"	Dimensions				Panel" (square)	Wall Opening" (square)	Wt. lbs.
									G"	H"	J"	K"		
EA368	7	1/30	121	60	11.1	4	4	8.06	2.38	8	3	11 1/8	8 1/2	10
EA369	10	1/30	611	318	13.1	6	6	8.06	2.38	10	3	13 1/8	10 1/2	10
EA370	12	1/30	815	490	15.1	8	8	8.06	2.38	12	3	15 1/8	13	12
EA371	16	1/20	1216	765	19.1	12	12	9.06	2.38	16	4	19 1/8	17	20
EA372	18	1/15	1877	752	21.1	14	14	11	2.5	18	4.8	21 1/8	18 1/2	25
EA373	20	1/15	2235	920	23.1	16	16	11	2.5	20	4.8	23 1/8	20 1/2	35
EA374	24	1/4	3214	2015	27.1	20	20	12.7	3	24	5	27 1/8	25	48
EA375	30	1/4	4970	3510	33.1	26	26	12.7	3	30	5	33 1/8	30 1/2	57

36" BELT DRIVE DRUM FANS

- 115 V, 1/2 HP, 2-speed, 1-phase, ball bearing motor
- 3-bladed aluminum propellers
- 2-speed rocker switch
- Epoxy-coated barrel and steel resilient mounted guards
- Steel wheels with rubber tires
- Easy grip handle with cord wrap
- 10' cord with 3-prong plug
- Tilttable
- CFM: 7800 (high), 5300 (low)
- RPM: 660 (high), 450 (low)
- Weight: 116 lbs.

2-YEAR WARRANTY



Model No. EA318

42" BELT DRIVE DRUM FANS

- 115 V, 1 HP, 2-speed, 1-phase, ball bearing motor
- Motor out of air stream – stays clean
- Aluminum 4-bladed propellers
- Rocker switch
- Epoxy-coated steel spiral, resilient mount guards
- Steel hubbed wheels, swivel locking casters
- 20 gauge roll form epoxy-coated housing
- 10', 3-conductor cord and plug
- CFM: 17 000 (high), 9558 (low)
- RPM: 430 (high), 285 (low)
- Quiet operation: 75 dB (high), 67 dB (low)
- Weight: 130 lbs.

2-YEAR WARRANTY



Model No. EA319

LIGHT INDUSTRIAL DIRECT DRIVE DRUM FANS

- 120 V/60 Hz, 2-speed motor
- All-metal construction, painted black
- 6' SJT power cord
- 6" casters and easy moving handle



Model No.	Blade size"	HP	Watts	CFM		Wt. lbs.
				High	Low	
EA286	28	2/5	290	8050	6650	22
EA288	36	3/5	405	11200	9100	30.5

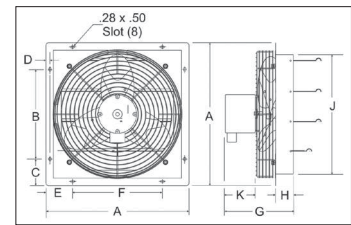

PORTABLE OPEN COIL HEATERS

- Two heat settings (1500 W and 1000 W) provide full comfort and efficient operation
- Fully adjustable automatic thermostat
- Safety overload switch
- Power signal light
- Top-mounted handle and controls
- Grounded plug and controls
- 7.67" L x 8.38" W x 6.1" H



Model No.	Volts	Watts	BTU/H	Amps
EA469	120	1000/1500	3410/5120	8.3/12.5

PORTABLE FAN-FORCED/RADIANT UTILITY HEATERS

- Three heat settings provides full comfort and efficient operation
- 600 W radiant
- 900 W fan-forced
- 1500 W fan-forced and radiant
- Chrome-plated safety grill
- Automatic built-in thermostat
- Ceramic core element
- Tip-over safety switch and thermal limit
- 10.83" L x 12.6" W x 16.54" H



Model No.	Volts	Watts	BTU/H	Amps
EA466	120	600/900/1500	2048/3072/5120	5.0/7.5/12.5

OIL-FILLED HEATERS

- 1500-W, 7-fin, oil-filled heater
- Three heat settings provide full comfort and efficient operation
- Adjustable thermostat
- Built-in over heating protection
- 120 V

Model No. EA612



PORTABLE UNDER DESK RADIANT HEATER

- Type: Radiant Heat
- Power Source: Electric
- Thin and lightweight
- Includes fold-out metal floor stand



Model No.	Volts	BTU Rating
EA651	120	580

SUN BLAST® SINGLE TANK-TOP RADIANT HEATER

- Efficient, heats radiantly, directly, no loss of heat to the air
- Economical, no electricity required
- Fits on a standard 20 lb. LP cylinder
- Variable BTU output
- Manual ignition
- Front and back protective grill
- No assembly required
- Heater shuts off automatically with loss of flame
- Natural Gas version also available
- Min BTU Rating: 9000 BTU/H
- Max BTU Rating: 15000 BTU/H
- Power Source: Propane
- Type: Radiant Heat

Model No. JG966



PORTABLE CERAMIC HEATERS

- Two heat settings (1500 W and 750 W) provide full comfort and efficient operation
- Adjustable thermostat
- PTC heating element
- Tip over safety switch and thermal safety fuse



Model No.	Volts	Watts	BTU/H	Amps
EA599	120	750/1500	2560/5200	6.25/12.5

PORTABLE FAN-FORCED UTILITY HEATERS

- Two heat settings (1300 W and 1500 W) provide full comfort and economic operation
- Adjustable thermostat
- Fan-only setting
- Tip over safety switch
- Built-in carrying handle with front safety guards



Model No.	Volts	Watts	BTU/H	Amps
EA598	120	1300/1500	4435/5120	10.8/12.5

PORTABLE FAN-FORCED CONVECTION HEATERS

- Two heat settings (1500 W and 750 W) provide full comfort and efficient operation
- Adjustable thermostat
- Wide-angle oscillation
- Tip over safety switch and thermal limit control



No. Model	Volts	Watts	BTU/H	Amps
EA597	120	750/1500	2560/5200	6.25/12.5

CONTRACTOR HEATERS

- Permanently lubricated motor
- Built-in thermostat
- Safety high temperature limit
- Steel spiral fin brazed to metal sheath elements for maximum heat transfer
- 6' heavy-duty cord
- Built-in handle/cord storage
- 12.8" L x 13.39" W x 15.87" H



Model No.	Volts	PH	Watts	BTU/H	Amps	Plug Type
EA477	240/208	1	5600	19 100	23.3/20.24	#6-30P
EA561	240	1	4800	16 380	20	#6-30P

HEAVY-DUTY CEILING MOUNT HEATERS

- Rugged heavy-duty industrial heaters
- Ideal for use in storage rooms, workshops, garages, warehousing
- Built-in ceiling bracket for easy mounting
- Automatic fan delay
- 240 V



Model No.	Max. BTU Rating	Max. Wattage	Motor
EA532	17 060 BTU/H	5000 W	Open
EA652	25 600 BTU/H	7500 W	Enclosed

PORTABLE CERAMIC HEATER

- Two heat settings (1500 W and 900 W) provide full comfort and efficient operation
- Power Source: Electric
- Adjustable thermostat
- Big carry handle
- 120 V



Model No. EA650

EXTENSIONS CORDS & PLUGS

OUTDOOR VINYL EXTENSION CORDS

- Designed for industrial and contractor use
- Vinyl jacket protects against rough use, chemicals and moisture, and provides added flexibility
- Molded-on and bonded plugs and connectors resist breaking

aurora tools®  

3-CONDUCTOR SJTW, 300-VOLT GROUNDING

Model No.	Length'	AWG	Amps	Watts	Colour
HEAVY-DUTY					
XC482	25	14/3	15	1875	Orange
XC483	50	14/3	15	1875	Orange
XC484	100	14/3	13	1625	Orange
EXTRA HEAVY-DUTY					
XC485	25	12/3	15	1875	Yellow
XC486	50	12/3	15	1875	Yellow
XC487	100	12/3	15	1875	Yellow



XC485

INDOOR/OUTDOOR STANDARD-DUTY EXTENSION CORDS

- Designed for light industrial, contractor, and home use
- Durable SJTW jacket protects against ultraviolet rays, chemicals and moisture
- Extremely flexible jacket
- Molded-on and bonded plugs and connectors resist breaking

aurora tools®  

3-CONDUCTOR SJTW, 125-VOLT GROUNDING

Model No.	Length'	AWG	Amps	Watts	Colour
XC630	10	16/3	13	1625	Orange
XC631	15	16/3	13	1625	Orange
XC632	25	16/3	13	1625	Orange
XC633	50	16/3	13	1625	Orange



XC630

OUTDOOR VINYL EXTENSION CORDS WITH LIGHT INDICATOR

- Designed for industrial and contractor use
- Vinyl jacket protects against rough use, chemicals, and moisture
- Ultra flexible cord
- Lighted connectors allow you to see when the power is in use
- Molded-on and bonded plugs and connectors resist breaking
- Water resistant and flame retardant

aurora tools®  

3-CONDUCTOR SJTOW, 300-VOLT GROUNDING, OIL RESISTANT

Model No.	Length'	AWG	Amps	Watts	Colour
EXTRA HEAVY-DUTY					
XC494	25	12/3	15	1875	Yellow
XC495	50	12/3	15	1875	Yellow
XC496	100	12/3	15	1875	Yellow



XC494

ALL WEATHER TPE-RUBBER EXTENSION CORDS WITH LIGHT INDICATOR

- Designed for industrial and contractor use
- All weather jacket provides ultra flexibility and superior performance in extreme climate conditions at temperatures from -50°C to 105°C
- Provides outstanding resistance against rough use, sunlight, chemicals and moisture
- Water resistant and flame retardant
- Lighted connectors allow you to see when the power is in use
- Molded-on and bonded plugs and connectors resist breaking

aurora tools®  

3-CONDUCTOR SJEOW, 300-VOLT GROUNDING

Model No.	Length'	AWG	Amps	Watts	Colour
HEAVY-DUTY					
XC500	25	14/3	15	1875	Blue/Orange
XC501	50	14/3	15	1875	Blue/Orange
XC502	100	14/3	15	1625	Blue/Orange
EXTRA HEAVY-DUTY					
XC503	25	12/3	15	1875	Blue/Orange
XC504	50	12/3	15	1875	Blue/Orange
XC505	100	12/3	15	1875	Blue/Orange



XC500

OUTDOOR VINYL TRIPLE TAP EXTENSION CORDS

- Designed for industrial and contractor use
- Vinyl jacket protects against rough use, chemicals, and moisture
- Vinyl jacket provides added flexibility
- Molded-on and bonded plugs and connectors resist breaking

aurora tools®  

3-CONDUCTOR SJTW, 300-VOLT GROUNDING



Model No.	Length'	AWG	Amps	Watts	Colour
HEAVY-DUTY					
XC488	25	14/3	15	1875	Red
XC489	50	14/3	15	1875	Red
XC490	100	14/3	13	1625	Red
EXTRA HEAVY-DUTY					
XC491	25	12/3	15	1875	Red
XC492	50	12/3	15	1625	Red
XC493	100	12/3	15	1625	Red



XC491

PVC GROUNDING PLUGS & CONNECTORS

- Moisture and chemical resistant plastic body
- Ideal for indoor and outdoor use
- Body Material: Plastic
- Amperage: 15A
- Voltage: 125V

NEMA CONFIGURATION
 
 NEMA 5-15P NEMA 5-15R



XE672

aurora tools®

Model No.	Nema Configuration	Description	Cord Diameter"	Wire Gauge stranded
XE672	5-15P	PVC Grounding Plug	0.245-0.655	16/3 to 14/3 cords
XE673	5-15R	PVC Grounding Connector	0.245-0.655	16/3 to 14/3 cords

EXTENSION CORDS & SPOTLIGHTS

ARCTIC BLUE™ ALL-WEATHER TPE-RUBBER LITE END EXTENSION CORDS

Arctic Blue™ all-weather Prime-Flex2™ TPE-rubber triple tap extension cords are designed for use by contractors and industrial personnel, providing an all-weather cordset made for outstanding performance in extreme climate conditions at temperatures from -58°F to 221°F.

Arctic Blue™ TPE-rubber cordsets offer superior resistance to ozone, oils, chemicals and rough handling. Flame retardant and water resistant. Certified for sale in Canada by an accredited certification body.



XB904

PRIME



NEMA 5-15R



XB895



NEMA 5-15P



NEMA 5-15R



SINGLE-OUTLET SJEW, 300-VOLT GROUNDING

Model No.	Length'	AWG	Amps	Watts	Colour
HEAVY-DUTY					
XB894	25	14/3	15	1875	Blue/Orange
XB895	50	14/3	15	1875	Blue/Orange
XB896	100	14/3	13	1625	Blue/Orange
EXTRA HEAVY-DUTY					
XB897	25	12/3	15	1875	Blue/Orange
XB898	50	12/3	15	1875	Blue/Orange
XB899	100	12/3	15	1875	Blue/Orange

TRIPLE-TAP SJEW, 300-VOLT GROUNDING

Model No.	Length'	AWG	Amps	Watts	Colour
EXTRA HEAVY-DUTY					
XB902	25	12/3	15	1875	Blue/Orange
XB903	50	12/3	15	1875	Blue/Orange
XB904	100	12/3	15	1875	Blue/Orange

WOBBLELIGHT® SELF-RIGHTING WORK LIGHTS

Bright and dependable, the self righting Wobblelight® delivers maximum light output in a highly durable and portable package with no hot surfaces.

- Ideal anywhere temporary high-output lighting is needed, such as indoor and outdoor construction sites, manufacturing, plant maintenance, fire and rescue
- Floating shock system protects bulb from impact
- Counter-weighted self righting design
- 360° lighting output adjustable to 180° with optional reflector
- Optional nylon reflector shield allows you to maintain 100% light source and focus it
- Internal ventilation system keeps light cool to the touch
- No set up – plugs into 120 VAC supply
- **XC332** and **XC334** include receptacle for connecting units in a series
- Certified for sale in Canada by an accredited certification body

Model No.	Mfg. No.	Description	Light Output Lumens	Lighting Area
XC746*	WL85F	85 W Fluorescent, 27" High	5000	15-25'
XC332	WL175MH	175 W Metal Halide, 36" High	15 000	30-42'
XC334	WL400MH	400 W Metal Halide, 36" High	40 000	78-110'

ACCESSORIES

Model No.	Mfg. No.	Description
XC747*	WL62230	180° Arc Reflector Shield for XC746
XC335	WL52230	180° Arc Reflector Shield for XC332 and XC334
XC749	111810	Replacement Transparent Dome w/Cap for XC746
XC453	111801	Replacement Transparent Dome w/Cap for XC332 and XC334

REPLACEMENT BULBS

XC748*	WL62260	Replacement Bulb for XC746
XB213	M175/U	Replacement Bulb for XC332
XC454	M400/U/ET18	Replacement Bulb for XC334

*Energy efficient

LED HEADLAMP

- Adjustable in/out zoom
- Water resistant
- Run Time Hrs. (Low): 20 • Run Time Hrs. (High): 6
- Lumens (Low): 30 • Lumens (High): 120
- 3 settings: High, Low and Strobe
- Head angle is adjustable
- Battery Type AAA
- Beam Distance (High): 120 m
- Batteries Not Included

Model No. XE887

aurora tools



MINI LED FLASHLIGHTS

- Nine ultra bright LED lights
- 25 lumens
- High-strength aluminum casing
- On/Off switch
- Lightweight design
- Rugged impact resistant housing
- Includes wrist strap and three AAA alkaline batteries
- Certified for sale in Canada by an accredited certification body

Model No. XD079

aurora tools



LED FLASHLIGHTS

- High strength aluminum casing
- Shatterproof lens
- Batteries Included
- Battery Type: AAA
- Body Material: Aluminum

aurora tools



XE888

Model No.	Lumens (High)	Run Time Hrs. (High)	Beam Distance (High)
XE888	98	2	35 m
XE889	157	2	45 m

XC746



XC332



Arc Reflector Shield XC335

WORK LIGHTS & FLASHLIGHTS

MAG CHARGER® RECHARGEABLE LED SYSTEM FLASHLIGHTS

- High-tech metallic reflector, combined with a tempered glass lens that delivers superior optical performance
- Durable sleek black finish, hard-anodizing inside and out for improved durability
- O-ring sealed throughout for resistance to weather and harsh environmental conditions
- Precision machined high-strength aluminum alloy case
- Individually serial numbered for identification
- NiMH rechargeable battery offers 434 m powerful projecting LED adjustable beam
- 643 lumens lasting 17 hours at low setting or 4 hours at high setting
- Quick access to your preferred functions: Full power, Power save (25%) Strobe (5/sec), SOS (Int'l Morse code), Momentary On/Off
- Length: 12 1/2"
- Weight: 2 lbs.

XD007 System (V4) Includes:

Mag Charger® flashlight, charging cradle, NiMH rechargeable battery pack, two mounting brackets, 120 V converter, mobile power adapter (12 V)



MAGLITE® LED

Use the XD007 rechargeable system just as it is (see Function Set #1 Standard) or personalize it to meet your own needs by choosing one of the other function sets in the chart shown below.

	Function Set 1 (standard)	Function Set 2	Function Set 3	Function Set 4
1 Click	Full Power	Full Power	Momentary	Momentary
2 Clicks	Power Save	Power Save	Full Power	Full Power
3 Clicks	Strobe	SOS Signal	Power Save	Strobe

Model No.	Mfg. No.	Description	Lumens
XD007	RL1019	Rechargeable LED System	643
XC849	ARXX235	Replacement NiMH Battery Pack	-

FLASHLIGHTS

- Super bright LED bulb
- Polypropylene body resists grease and chemicals
- Shatterproof lens
- Ribbed non-slip barrel
- Hi-Viz yellow colour for easy visibility
- Batteries not included



aurora tools®

Model No.	Description	Lumens
XC977	Flashlight, 2 AA-cells	28
XC978	Flashlight, 2 D-cells	35

HARD CASE PROFESSIONAL™ 2 AA LED FLASHLIGHTS

- 300 lumens
- Water resistant IPX4
- Shatterproof lens
- Impact resistant steel plate bolted sides
- Run time Hrs.: 6 hrs. 30 min. high, 30 hrs. low
- Includes 2 long lasting AA Energizer® alkaline batteries
- Beam Distance: 115 meters

Model No. XC234
Mfg. No. TUF2AAPE

Energizer



REPLACEMENT BATTERY, AA, 24/Pkg.
Model No. XB872

MINI MAGLITE® LED & PRO™

- Powerful projecting LED beam that focuses simply by rotating the head
- Balanced Optics™ combines a highly refined reflector with a performance enhanced LED yielding high output intensity
- Intelligent energy source management allows the user to choose the power level
- Multi-mode electronic switch: 100% power, 25% power, blink, SOS
- Length: 6.6"
- MagLite® Pro™ offers latest generation LED
- **Includes:** Two AA size alkaline batteries and belt holster

XC238



MAGLITE® LED

- Powerful projecting LED beam that focuses spot to flood simply by rotating the head
- Balanced Optics™ combines a highly refined reflector with a performance enhanced LED, for a brilliant adjustable beam
- Intelligent energy source management balances high brightness with extended battery life
- Rugged, machined aluminum construction with knurled design
- Anodized inside and out for improved corrosion resistance
- Water and shock resistant
- Batteries not included

XC240



Model No.	Mfg. No.	Description	Lumens	Beam Distance Metres
XC238	SP2201H	Mini Maglite® LED Flashlight, 2 AA Cells	97	145
XC814	SP2P01H	Mini Maglite® LED PRO™ Flashlight, 2 AA Cells	272	163
XC239	ST2D016	Maglite® LED Flashlight, 2 D Cells	168	412
XC240	ST3D016	Maglite® LED Flashlight, 3 D Cells	168	412

BATTERIES

XB872	EN91	Replacement Batteries AA, 24/Pkg.	-	-
XB875	EN95	Replacement Batteries D-Cell, 12/Pkg.	-	-

STYLUS PRO® & MICROSTREAM® PENLIGHTS

- Compact, high-powered LED penlights provide a super bright beam
- Constructed of corrosion proof, machined aircraft-grade aluminum alloy with Type II MIL-Spec anodized plating
- 30000 hour lifetime 0.5 watt LED never needs to be replaced
- Water resistant per code IPX4; in accordance with specification EN 60529:1992
- Tail switch features momentary blink and constant "on" modes
- Matte black finish



XC394

XC395

STREAMLIGHT

STYLUS PRO®

- Produces up to 90 lumens
- Run time: Up to 6.5 regulated hours
- Includes: 2 AAA alkaline batteries, nylon holster and pocket clip

Model No. XC394
Mfg. No. 66118

MICROSTREAM®

- Produces up to 45 lumens
- Run time: Up to 2.25 hours
- Includes: 1 AAA alkaline battery, pocket clip and lanyard

Model No. XC395
Mfg. No. 66318

ENERGIZER® BATTERIES ALKALINE INDUSTRIAL PACKAGING



Sold per package

Model No.	Mfg. No.	Description	Qty /Pkg
XB873	EN92	AAA/1.5 V	24
XB872	EN91	AA/1.5 V	24
XB874	EN93	C/1.5 V	12
XB875	EN95	D/1.5 V	12
XB876	EN22	9 V	12

CORD REELS & WORK LIGHTS

BEACON 360° WIDE AREA LED LIGHT

- Light temperature: 4500K (bright white light - no blue tint)
- 13 000 lumens equivalent usable light of a 400 W metal halide
- Environmental rating: IP64 (weatherproof)
- Construction: Cast aluminum housing, polycarbonate lenses
- Switch: On/Off rocker switch
- Weight: 10 lbs. (light head only)
- Height: 14" (light head)
- Diameter: 6" (light head)
- 120 W
- Lighting range: 50'
- Approvals: cETLus portable work light

Model No.	Description
XE636	W/Magnet Mount
XE637	W/Clamp
XE638	W/Tripod



XE636



XE637



XE638

PORTABLE HALOGEN WORK LIGHTS

- 500-watt halogen work light
- Heat resistant tempered glass face
- Adjustable tilting head
- Halogen bulb included
- Certified for sale in Canada by an accredited certification body

Model No. XC949

REPLACEMENT BULB

Model No. XC951



WORK REELS

Certified for sale in Canada by an accredited certification body.

INCANDESCENT WORK LIGHT REELS

- Incandescent work lights are rated for 75 W bulbs
- Includes switch and circuit breaker protected convenience outlet
- Grounded metal guard with reflector protects the bulb

EXTENSION REELS

- Triple outlet extension reel with reel circuit breaker

13 W FLUORESCENT WORK LIGHT REELS

- Light output of 900 lumens
- Rugged polycarbonate shield is easily removed for tool-free lamp replacement
- **Includes:** Switch, hanging hook, and full-length reflector



TWIN HEAD HALOGEN WORK LIGHTS

- Twin 500-watt halogen lights
- Heat resistant tempered glass face
- Adjustable tripod for desired height
- Extendable tripod legs provide greater stability
- Halogen bulbs included
- Certified for sale in Canada by an accredited certification body

Model No. XC950

REPLACEMENT BULB

Model No. XC951



Model No.	Description
INCANDESCENT WORK LIGHT REELS	
XA155	30' 16/3 SJT Cord, 9 A Rating
XA921	50' 18/3 SVT Cord, 6 A Rating
EXTENSION REELS	
XA154	30' 16/3 SJT Cord, 10 A Rating
XB281	30' 14/3 SJT Cord, 13 A Rating
FLUORESCENT WORK LIGHT REELS	
XA289	40' 18/2 SJT Cord
XA412	30' 16/3 SJT Cord, 9 A Outlet in Light



HAND-HELD FLOOD LIGHTS WITH MAGNET

- 500 W weatherproof fixture
- 8', 16-gauge heavy-duty cord
- Comfortable foam grip
- Powerful 40-lb. pull strength magnet quickly attaches to metal surfaces
- Lights up to 5000 sq. ft.
- Certified for sale in Canada by an accredited certification body

Model No. XA145

REPLACEMENT BULBS

Model No. XC464



HEAVY-DUTY FLUORESCENT WORK LIGHTS

- Cool running
- Shatter resistant polycarbonate tube
- Moisture and dust resistant
- 25', 18/2 SJTOW cord
- **Includes:** Enclosed starter switch, rubber end caps, a full-length reflector, and hanging hook
- Certified for sale in Canada by an accredited certification body

Model No. XA146 Twin tube, compact, 13 W, 900 lumens, 10" length

Model No. XA149 Linear tube, 15 W, 920 lumens, 22" length



RECHARGEABLE LED WORK LIGHTS

- 90 and 160 super bright LED lights
- Lightweight design
- Rugged impact resistant housing
- 3-4 hour run time on full charge
- **Includes:** Hanging hook, powerful magnet, 110 V adaptor and 12 V car plug
- Certified for sale in Canada by an accredited certification body

XC662

XC661



INCANDESCENT WORK LIGHTS

- Rated for a 100 W bulb
- Protected by heavy-gauge metal guard and reflector
- 14/3 SJTW cord
- **Includes:** Circuit breaker protected convenience outlet, rated for a full 15 A capacity
- Certified for sale in Canada by an accredited certification body

Model No. XA175 25' cord

Model No. XA918 50' cord



RECHARGEABLE LED WORK LIGHTS

- 26 super bright LED lights
- 3-4 hour run time with full charge
- **Includes:** 110 V adaptor and 12 V car plug
- Certified for sale in Canada by an accredited certification body

Model No. XC663



Model No.	No. of LED
XC661	90
XC662	160

SHOP HOSE REELS & VISES

HOSE REELS

- Suitable for air and water
- Heavy-duty, reinforced steel stampings for increased strength
- Compact design allows reels to fit in tight locations
- Multi-position guide arms for multiple mounting options
- Kinkless, oil resistant high quality hose
- Spring rewind features long life spring with declutching arbour
- Durable, corrosion-resistant powder coat paint finish

Model No.	Drive Type	Hose I.D.	Hose Length'	Max PSI	Hose Outlet (M) NPT"	Reel Inlet (F) NPT"	Dimensions			Wt. lbs.
							W"	x D"	x H"	
TLZ482	Spring	1/4	35	300	1/4	3/8	6	x 15 1/2	x 14	26.6
TLZ483	Spring	3/8	25	300	1/4	3/8	6	x 15 1/8	x 13 7/8	26.2
TLZ484	Spring	3/8	35	300	1/4	3/8	6 5/8	x 17 1/2	x 16 1/2	34.7
TLZ485	Spring	3/8	50	300	1/4	3/8	6 1/2	x 20	x 18 3/8	40.3
TLZ486	Spring	1/2	50	300	1/2	1/2	6 5/8	x 20 1/4	x 17 7/8	44.3



aurora tools®

AIR/WATER DELIVERY REELS

- Lightweight and easy to handle
- Made of corrosion proof polypropylene
- Working temperature: up to 65°C
- Designed to protect the hose and allow for easy cleaning of both hose and reel
- Wall or floor mount (Floor stand not included)
- Hose included

Model No.	Mfg. No.	Hose I.D."	Hose Length'	Max PSI	Hose Outlet (M) NPT"	Reel Inlet (F) NPT"	W"	x D"	x H"	Wt lbs.
FH821	SGA36500LP	3/8	50	232	3/8	3/8	9 1/8	x 22	x 19 3/8	23
FH822	SGA36650LP	3/8	66	232	3/8	3/8	9 1/8	x 22	x 19 3/8	27
FH823	SGA38500LP	1/2	50	232	1/2	1/2	9 1/8	x 22	x 19 3/8	27



REELCRAFT

HOSE REELS

- Heavy-duty, reinforced steel stampings for increased strength
- Permanently lubricated for long, trouble-free service
- Multi-position guide arms for versatile mounting options
- Kinkless, high quality hoses
- Spring rewind features long life spring with declutching arbour
- Durable, corrosion-resistant powder coat paint finish

INDUSTRIAL STEEL REELS

Model No.	Mfg. No.	Drive Type	Hose I.D."	Hose Length'	Max PSI	Hose Outlet" (M) NPT	Reel Inlet" (F) NPT	Reel Outlet" NPT	Dimensions			Wt. lbs.
									W"	x D"	x H"	
AIR OR WATER REELS FOR MANUFACTURING PLANTS, BODY SHOPS, WORKSHOPS, SERVICE STATIONS, FABRICATORS, SPRAY BOOTHS - SOLD WITH HOSE												
TN315	4435-OLP	Spring	1/4	35	300	1/4	3/8	-	5 3/8	x 12 3/8	x 12 7/8	19
TN317	4625-OLP	Spring	3/8	25	300	1/4	3/8	-	5 3/8	x 12 3/8	x 12 7/8	20
TN316	5635-OLP	Spring	3/8	35	300	1/4	3/8	-	6	x 14 3/4	x 14 1/2	25
TN318	7650-OLP	Spring	3/8	50	300	1/4	1/2	-	5 3/4	x 19	x 20 1/4	43
TN319	7850-OLP	Spring	1/2	50	300	3/8	1/2	-	5 3/4	x 19	x 20 1/4	47
FI058	5450-OLP	Spring	1/4	50	300	1/4	3/8	-	6	x 14 3/4	x 14 1/2	26
FH533	5650-OLP	Spring	3/8	50	300	1/4	3/8	-	6	x 16 1/2	x 17 5/8	36
FH534	81100-OLP	Spring	3/8	100	300	3/8	1/2	-	10 1/2	x 24	x 25 3/8	112
FH490	82100-OLP	Spring	1/2	100	300	1/2	1/2	-	10 1/2	x 24	x 25 3/8	125
FH491	83050-OLP	Spring	3/4	50	250	3/4	3/4	-	10 1/2	x 24	x 25 3/8	118
FH492	D83075-OLP	Spring	3/4	75	250	3/4	3/4	-	14 1/4	x 24	x 25 3/8	132
FH493	D84050-OLP	Spring	1	50	250	3/4	1	-	15 1/4	x 24	x 25 3/8	133
FH494	E9350-OLP	Spring	3/4	50	250	3/4	3/4	-	15 3/4	x 26 1/4	x 26 1/4	170
FH495	E9450-OLP	Spring	1	50	250	3/4	1	-	15 3/4	x 26 1/4	x 26 1/4	187
HAND CRANK FOR AIR OR WATER - DESIGNED FOR MEDIUM-DUTY APPLICATIONS REQUIRING LONGER LENGTHS OF HOSE - SOLD WITHOUT HOSE												
FH506	CA32106L	Manual	1/2	100	1000	-	1/2	1/2 (F)	19 3/4	x 17 3/4	x 20 1/4	40
FH507	CA32112L	Manual	1/2	200	1000	-	1/2	1/2 (F)	25 3/4	x 17 3/4	x 20 1/4	46
FH508	CA33112L	Manual	3/4	100	1000	-	3/4	3/4 (F)	19 3/4	x 17 3/4	x 20 1/4	46
FI060	CA37118L	Manual	1	100	300	-	1	1 (M)	34	x 17 3/4	x 20 1/4	58



TN315

FH507

REELCRAFT

HEAVY-DUTY FIXED BASE BENCH VISES

- 80000 PSI Industrial grade ductile iron
- Built in pipe jaws hold round objects
- Hardened anvil striking surface used for forming & shaping
- Safety locking plate in base prevents the vise from slippage



aurora tools®

Model No.	Jaw Width"	Jaw Opening"	Throat Depth"
TYL093	4	4 1/2	2 7/10
TYL094	5	5 1/2	3 3/10
TYL095	6	6 1/2	3 1/2
TYL096	8	8 1/2	4

HEAVY-DUTY SWIVEL BASE BENCH VISES

- 80000 PSI Industrial grade ductile iron
- Built in pipe jaws hold round objects
- Hardened anvil striking surface used for forming & shaping
- Safety locking plate in base prevents the vise from slippage



aurora tools®

Model No.	Jaw Width"	Jaw Opening"	Throat Depth"
TYL098	4	4 1/2	2 1/2
TYL099	5	5 1/2	3
TYL100	6	6 1/2	3 4/10
TYL101	8	8 3/10	3 8/10

FUNNELS & LUBRICATING EQUIPMENT

CALL FOR A QUOTATION WHEN FUNNELS ARE TO BE USED IN FOOD INDUSTRY.

STEEL FUNNELS WITH EXTENSION

Galvanized steel funnel comes with a flexible extension. 1/2" diameter hose for 1-pint model, 3/4" diameter for larger sizes.

Model No.	Cap.	Top Dia."	Hose Spout Length"	Spout Dia."
NB027	1 pint	4 3/4	9	3/8
NB028	1 quart	5 7/8	8	1/2
NB025	1/2 gallon	7 5/8	8 1/2	1/2
NB026	1 gallon	8 7/8	10	1/2



UTILITY FUNNELS

Lightweight tin and galvanized steel funnels are available in capacities from 1 pint to 1 gallon.

Tin Model	Galv. Model	Cap.	Top Dia."	Body Ht."	Spout Ht."	Spout Dia."
NB077	NB031	1 pint	4 3/4	3 7/16	2 1/16	3/8
NB078	NB032	1 quart	5 3/4	4 5/16	2 3/8	1/2
NB075	NB029	1/2 gallon	7 1/2	5 5/8	2 11/16	5/8
NB076	NB030	1 gallon	8 3/4	6 1/2	3 1/2	3/4



STRAINER FUNNELS

Tin strainer funnels have a built-in screen that prevents the flow of harmful particles into the liquid.

Model No.	Cap.	Top Dia."	Body Height"	Spout Height"	Spout Dia."
NB069	1 pint	4 3/4	3 7/16	2 1/16	3/8
NB070	1 quart	5 3/4	4 5/16	2 3/8	1/2
NB067	1/2 gallon	7 1/2	5 5/8	2 11/16	5/8
NB068	1 gallon	8 3/4	6 1/2	3 1/2	3/4

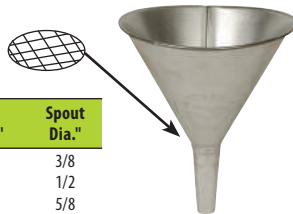

DIECAST ALUMINUM SCOOPS

Bowl and handle are cast in one piece for extra heavy-duty use. Ideal for powders and granulated products.

Model No.	Capacity	Bowl Length"	O.A. Length"
NG648	3/4 quart	7 3/4	11 1/4
NG649	1 quart	9	13
NG650	1 1/2 quart	10 1/2	15



SCOOPS

Constructed from heavy-duty white polyethylene or clear polycarbonate resin. Smooth surfaces for easy cleaning.

Model No.	Colour	Cap oz.
NA995	Clear	6
NA996	Clear	32
NA997	White	64
NH294	Clear	64



POLYETHYLENE FILTER FUNNELS

- Made of chemical resistant polyethylene
- A screen filter is included

Model No.	Description	Diameter"
YC564	Straight Spout	5
NC991	Straight Spout	9
TYB517	Curved Spout	8
TYB518	Curved Spout	9 1/2



LIQUID MEASURES

- Translucent high density polyethylene construction
- Comes complete with a polyethylene flexible spout for difficult to reach areas
- Cap on flexible spout and polypropylene lid renders measure spill proof
- Spout length: 7 1/2"
- Spout diameter: 3/4"

Model No.	Capacity
TYB513	1 quart
TYB514	2 quart
TYB515	3 quart
TYB516	5 quart



LIQUID MEASURES

FLEXIBLE SPOUTS

Spill proof top. Flexible spout makes it easy to reach difficult areas and hard to reach pouring angles. 8" flexible spout length. 1/2" spout diameter.

Tin Model No.	Top Dia."	Galvanized Model No.	Stainless Model No.	Top Dia."	Cap.
NB082	4 1/4	NB035	NB056	4	1 quart
NB079	4 1/4	NB033	NB052	5	1/2 gallon
NB081	6	NB034	NB054	6	1 gallon



GREASE GUNS

LEVERS

- Capacity: 14 oz. (400 g)
- Complete with 6" steel extension and 4-jaw coupler with ball check

aurora tools®

STANDARD-DUTY LEVER

- Develops 6000 PSI

Model No. AC472



HEAVY-DUTY LEVER

- Develops 10000 PSI

Model No. AC473



HEAVY-DUTY PISTOLS

- Capacity: 14 oz. (400 g) grease cartridge or suction fill
- Develops 5000 PSI
- AC475 comes complete with 4" steel extension and 4-jaw coupler with ball check
- AC476 comes complete with 18" flexible hose and 4-jaw coupler with ball check

Model No. AC475
4" steel extension

Model No. AC476
18" flexible hose

aurora tools®



EZEE-LUBE KITS

- Kit comprises of a range of quick-connect lube accessories

Model No. AC492



OIL CANS

- Heavy-gauge tin coated metal
- Premium powder coat finish

aurora tools®

Model No.	Capacity oz.	Spout Length	Spout Type	Pump
AC514	6	6	Flexible	Steel
AC515	10	6	Flexible	Steel
AC516	16	7	Flexible	Steel
AC592	16	9	Flexible	Steel
AC593	16	9	Rigid	Steel
AC590	23	8	Flexible	Steel
AC594	33	9	Flexible	Steel
AC595	33	9	Rigid	Steel

PISTOL TYPE

AC588	4	5	Flexible	Steel
AC513	6	5	Flexible	Steel
AC596	6	6	Rigid	Steel
AC599	16	6	Flexible	Steel



PARTS CLEANING EQUIPMENT

WASH TANKS

- Cover opens wide for access
- Self-closing mechanism and fusible link which melts at 165°F and snaps the cover shut in case of fire
- Integral parts basket facilitates washing quantities of small parts quickly
- Can and basket are made of sturdy 24-gauge coated steel
- After cleaning, the basket is positioned at the top of the tank to allow solvent to drain
- Available with polyethylene liner for outstanding chemical resistance to harsh, corrosive chemicals



SM432



Model No.	Mfg. No.	Description	Outside Dimensions Dia." x H"	Approved Regulation	Wt. lbs./kg
WN971	27711	1-Gallon Steel w/Basket	9 3/8 x 10	FM, TUV	7/3.2
WN972	27712	2-Gallon Steel w/Basket	11 3/8 x 11 1/4	FM, TUV	10/4.5
WN973	27713	3.5-Gallon Steel w/Basket	13 3/4 x 13	FM, TUV	12/5.5
WN974	27723	3.5-Gallon Steel w/HDPE Liner and Basket	13 3/4 x 13	FM, TUV	13/5.9
SM432	27716	6-Gallon Steel w/Basket	15 5/8 x 14 1/4	FM, TUV	15/6.8

SMARTWASHER® SYSTEMS

The SMARTWASHER® System consists of a sturdy, impact resistant, self-contained washing unit with a flexible nozzle and brush that directs warmed cleaning fluid for parts washing. The fluid works in conjunction with a special microbe impregnated filter to effectively clean the dirtiest parts. Each unit requires 25 gallons of SMARTWASHER fluid and one filter for start-up.



SMARTWASHER® UNITS FEATURE:

- Flexible nozzle and brush
- Recirculating pump
- Low fluid indicator light/low fluid automatic shut-off
- Impact resistant construction
- Thermostat
- Energy efficient heater

SMARTWASHER® 41

- Removable sink for easy cleaning
- Sink dimensions: 43" H x 34" W x 42" D

Model No. AF127

Mfg. No. 14144



SMARTWASHER® MOBILE UNIT

- Built-in dolly allows for easy mobility
- Sink dimensions: 20 cm H x 69 cm W x 58 cm D

Model No. AF128

Mfg. No. 14161



SMARTWASHER® CLEANING SOLUTIONS & FILTERS

Model No.	Mfg. No.	Description	Container Size	Units /Case	NSF
AF129	14148	Industrial Grade Cleaning Solution	18 L Jug	1	A1
AF130	14156	Automotive & Ink Grade Cleaning Solution	18 L Jug	1	A1
AF131	14158	Specialty Metals Cleaning Solution	18 L Jug	1	A1
NH776	14147	Premium Filters	1 Case	6	

BENCH CANS

- Cleans small parts easily in solvents
- Plated steel dasher is an effective flame arrester
- Made of sturdy 24-gauge coated steel



Model No.	Mfg. No.	Description	Dasher Dia."	Dimensions O.D." x H"	Approved Regulations	Wt. lbs./kg
WN978	10175	1-Quart Steel Can	4 1/2	4 7/8 x 5 1/2	FM	2/0.9
AB491	10295	2-Quart Steel Can	7 1/2	9 3/8 x 3 1/4	FM	4/1.8
AB492	10375	1-Gallon Steel Can	7 1/2	9 3/8 x 4 1/2	FM	5/2.3
AB493	10575	2-Gallon Steel Can	9 3/4	11 1/2 x 5 3/8	FM	8/3.6
AB494	10775	3-Gallon Steel Can	12 1/8	13 1/2 x 6	FM	10/4.5

RINSE TANKS

- Large parts (up to 16" x 35") can be totally immersed
- Heavy-duty, 18-gauge coated steel construction
- 3/4" drain plug for easy solvent replacement
- Tough powder coat paint finish for superior durability and chemical resistance

FLOOR STANDING RINSE TANKS

- Supported on a sturdy stand, 33" height for convenient access whether standing or seated
- Self-closing cover is foot-treadle operated so it can be opened by a worker with both hands full
- Adjustable-rate pneumatic cylinder prevents cover from slamming shut instantly



BENCH TOP RINSE TANKS

- Sit conveniently on work bench or counter for easy access
- Lift-and-latch style cover has fusible link that melts at 165°F and closes the cover in case of fire

SEDIMENT SCREENS

- 26-gauge premium coated steel
- Rests at bottom of tank to catch grime as it settles and allows for easy cleaning during solvent change

Model No.	Mfg. No.	Description	Dimensions L" x W" x D"	Approved Regulations	Wt. lbs./kg
-----------	----------	-------------	-------------------------	----------------------	-------------

FLOOR STANDING RINSE TANK

SM434	27110	11-Gallon Steel	24 x 16 x 8 3/4	FM	27/12.3
SM433	27220	22-Gallon Steel	35 1/4 x 16 x 12	FM	36/16.4

BENCH TOP RINSE TANK

SM431	27311	11-Gallon Steel	24 x 16 x 8 3/4	FM	13/5.9
WN975	27322	22-Gallon Steel	35 1/4 x 16 x 12	FM	22/10

SEDIMENT SCREENS

Model No.	Mfg. No.	Description	Dimensions L" x W" x D"	Wt. lbs./kg
SM437	27004	For SM434 and SM431	23 x 13 3/4 x 3/4	1/5
SM436	27006	For SM433 and WN975	35 x 13 3/4 x 3/4	1/5

PLUNGER CANS

Dispense flammable liquids and solvents safely onto cloths or swabs without waste or exposure.

- Plunger fills upper pan for soaking
- Surplus liquid drains safely back into can
- Brass pump parts resist corrosion
- Steel and polyethylene cans available
- FM approved



Model No.	Mfg. No.	Description	Capacity	Dimensions Outer Dia." x H"
SA129	10008	Steel Plunger Can	1 Pint	4 7/8 x 5-1/4
SA130	10108	Steel Plunger Can	1 Quart	7 1/4 x 5-5/8
SC309	10308	Steel Plunger Can	1 US Gallon	7 1/4 x 10-1/2
SC310	14018	Polyethylene Plunger Can	1 Quart	5 1/2 x 8-1/4

PAINT & PAINTING SUPPLIES

AP100 SERIES PAINT BRUSHES

- Brush Type: 100% black polyester bristles
- Handle: Solid plastic
- Tin-plated ferrule
- Well-suited for latex-based paints



aurora tools

Model No.	Width"
KP307	1
KP308	2

AP200 SERIES PAINT BRUSHES

- Brush Type: Pure white bristles
- Handle: Solid plain wood
- Tin-plated ferrule
- Well-suited for oil-based paints



aurora tools

Model No.	Width"
KP306	0.5
KP297	1
KP298	2
KP299	3

AP300 SERIES PAINT BRUSHES

- Brush Type: Natural bristles
- Handle: Solid plastic
- Tin-plated ferrule
- Well-suited for oil-based paints



aurora tools

Model No.	Width"
KP300	1
KP301	2
KP302	3
KP303	4

AP400 SERIES PAINT BRUSHES

- Brush Type: Foam brush
- Handle: Solid wood
- Disposable
- Well-suited for applying urethane or for touch-up jobs



aurora tools

Model No.	Width"
KP335	1

PAINTERS MASKING TAPE

- Colour: Green
- High quality painting tape adheres to multiple surfaces
- Reliable adhesion resists paint bleed-through
- Removes cleanly in one piece



aurora tools

Model No.	Length	Width
PF690	55 m (180')	25 mm (1")
PF691	55 m (180')	50 mm (2")

RUST TOUGH® ACRYLIC ENAMELS

AEROSOLS

- Complete coverage with one coat
- Dries to touch in 25 minutes; dries to handle in 1 hour
- Superior appearance and colour retention
- Ideal for small touch-up jobs, painting irregular shapes or covering hard-to-reach areas
- For both indoor and outdoor use
- Tough, high-gloss finish resists chipping and peeling
- Acrylic enamels and primers are equipped with EZ Touch® Fanspray® nozzle
- Case Qty: 6 cans

Applications: Steel, aluminum, properly primed metal and wood, structural steel, storage tanks, bar joists, handrails, piping, pipe racks, conveyors, ladders, fencing, machinery, metal doors and marine applications above boot topping.

Note: Not recommended for immersion.



NA356



Model No.	Colour	Size Can (Net)
AEROSOLS		
NA356	Flat Black	20 oz. (15 oz.)
NA386	Flat White	20 oz. (15 oz.)
NA360	Gloss Black	20 oz. (15 oz.)
NA393	Gloss White	20 oz. (15 oz.)
NA352	Semi-Gloss Black	20 oz. (15 oz.)
ZB013	Semi-Gloss White	20 oz. (15 oz.)
NA273	Safety Blue (OSHA)	20 oz. (15 oz.)
NA286	Safety Green (OSHA)	20 oz. (15 oz.)
NA322	Safety Orange (OSHA)	20 oz. (15 oz.)
NA330	Safety Red (OSHA)	20 oz. (15 oz.)
NA302	Safety Yellow (OSHA)	20 oz. (15 oz.)
NA326	Equipment Orange	20 oz. (15 oz.)
NA318	Equipment Yellow	20 oz. (15 oz.)
NA314	Industrial Yellow	20 oz. (15 oz.)
NA306	Federal Safety Railing Yellow	20 oz. (15 oz.)
NA382	Dark Machine Grey (Asa-49)	20 oz. (15 oz.)
NA368	Light Machinery Grey (Asa-61)	20 oz. (15 oz.)
NA294	Bright Green	20 oz. (15 oz.)
NA298	Dark Green	20 oz. (15 oz.)
NA334	Bright Red	20 oz. (15 oz.)
NA264	Aluminum	20 oz. (15 oz.)
NA269	Light Blue	20 oz. (15 oz.)
NA277	Deep Blue	20 oz. (15 oz.)
NA346	Chestnut Brown	20 oz. (15 oz.)
NA342	Tan	20 oz. (15 oz.)
NA435	Fluorescent Green	20 oz. (15 oz.)
NA436	Fluorescent Yellow	20 oz. (15 oz.)
NA437	Fluorescent Orange	20 oz. (15 oz.)
NA438	Fluorescent Red	20 oz. (15 oz.)
NA348	Hi-Temp Black	20 oz. (15 oz.)

PRIMERS

NA364	Grey Primer	20 oz. (15 oz.)
NA338	Red Oxide Primer	20 oz. (15 oz.)
NA375	Zinc-Rich Cold Galvanized Primer	20 oz. (15 oz.)

INDUSTRIAL & OFFICE SEATING

DELUXE SWIVEL STOOLS

- 360° swivel motion is ideal for workers who have repetitive side to side movement
- Seat easily adjusts to your selected height, just raise or lower the steel rod and lock securely in place
- 2" foam over a 1/2" plywood base and 1/2" foamed backrest
- All-welded frame constructed of 1" diameter 16-gauge steel
- 3/4" circular tube footrest
- Four leg cluster design has a 22" spread giving them optimum stability
- Black vinyl upholstery with a royal grey frame
- Optional casters available



OJ905 has an ergonomic self-skinned molded polyurethane foam seat and back, features lumber support, waterfall seat and 4-leg frame for superior comfort and durability.

Model No.	Adjustable Height"	Seat Dimensions"	Wt. lbs.
OJ905	25 - 31	19 x 17	33
FC670	25 - 31	19 x 17	33
FC675	Set of 4 Casters	-	2

STATIONARY & ADJUSTABLE HEIGHT STOOLS

Stationary



Adjustable



- Ruggedly built for long lasting service in a warehouse factory or office
- All-welded frame is a 7/8" diameter steel tube
- Legs are braced with a 3/4" 18-gauge circular footrest for increased strength and stability
- 14" diameter embossed steel seat has a 1/8" tempered hardboard inlay
- FC656 has a 14 1/2" x 15" sq. seat and is reinforced by steel bars
- All stools have four chrome floor glides that will not damage floors
- On the adjustable models the telescopic legs have screw locks that adjust on 1" increments
- Contoured back rest constructed of 19-gauge steel
- Royal grey

Model No.	Height"	Seat Dimensions"	Wt. lbs.
STATIONARY HEIGHT			
A. FC649	24	14	20
B. FC647	24	14	12
B. FC648	30	14	14

Model No.	Height"	Seat Dimensions"	Wt. lbs.
ADJUSTABLE HEIGHT			
C. FC653	25 - 33	14	12
D. FC655	25 - 33	14	20
E. FC656	18 - 26	14 1/2 x 15	18

SPECIALTY STOOLS

- Designed specifically for laboratories and medical offices
- 14" diameter, 3" high, vinyl-covered seat
- Pneumatic mechanism to adjust the height
- Footring is standard on stools with a 20" - 33" adjustable height, optional on the other stools
- Optional casters or glides available



MUR-VAN MANUFACTURING

Model No.	Adjustable Height"	Wt. lbs.
WITH CASTERS		
OC785	16 - 22	14
OC786	20 - 28	18
OC787	23 - 33	20
WITH GLIDES		
OC788	16 - 22	14
OC789	20 - 28	18
OC790	23 - 33	20

Optional footring OC819 for heights 16"-22" and 21"-28" only

SWIVEL STOOLS

- Seats made of 19-gauge embossed steel with 1/8" tempered hardboard inlay
- 1" diameter, 16-gauge steel frame all-welded tubing
- Circular 18-gauge footrest guarantees comfort and stability
- Heavy-duty rubber cushioned steel glides protect floors
- 1" x 14 1/2" long steel adjustment stem for easy height selection on all units
- 9 1/2" x 15 3/4" backrest is 4-way adjustable
- Optional casters available: FC675



Model No.	Adjustable Height"	Seat Dimensions"	Wt. lbs.
FC658	22 - 28	14	19
FC661	22 - 28	14	28
FC665	17 - 23	14 1/2 x 15	27
FC675	Set of 4 Casters	-	2

SIT/STAND STOOLS

- Sit/stand stools dramatically reduce fatigue for workers unable to sit down on the job
- Can be positioned for up close work
- FC683 heavy gauge triangular glides provide safety, features a built-in footrest, a 15" wide x 13 7/8" high self skinning polyurethane seat mounted to an adjustable spring suspension frame that automatically tilts forward up to 15° while in use
- Removable seat attaches to frame with a double pin locking system which easily adjusts to 12 positions from 21" to 35"
- FC685 features a sturdy, tip proof 5-leg base with a padded comfortable "Bicycle style" seat
- Pneumatic height adjustment from 23 1/2" to 33 1/2"

Model No. FC683 Manual Adjustment
Model No. FC685 Pneumatic Adjustment



INDUSTRIAL & OFFICE SEATING

INDUSTRIAL SEATING

- Features a full 8" of pneumatic lift while seated
- Exclusive extension tube provides an adjustable height range of 17" to 35"
- Seats and backs are microcellular self skinning polyurethane foam which inhibits punctures, tears and moisture absorption
- Large 26" diameter 5-leg steel base with 2 1/2" diameter glides ensure stability and safety even at the highest levels
- Large wide angle footrests make it easy to step up into seat



FC680
Features 22° back angle and 10° seat tilt adjustment w/double paddle handles.



FC681
Features 3" back rest height and 3" back rest depth adjustment.
Assembly required.



Model No.	Dimensions"				No. of Footrests
	Seat		Backrest		
FC680	18-1/2	x 17	15-3/4	x 9	3
FC681	16-1/4	x 16-1/4	14-1/2	x 9	1

PNEUMATIC SWIVEL STOOLS

- 5" gas lift
- Height adjusts from 15" to 20 1/2"
- Black select vinyl
- Weight: 10 lbs

Model No. OD846



OD847



- 10" gas lift
- Height adjusts from 22" to 32"
- Options SKR18 footring
- Weight: 12 lbs

Model No. OD847

STEEL BASE SWIVEL STOOLS

- 5" pneumatic lift of 25" to 30", for easy height adjustment
- Five legs and an all-welded steel base, gives optimum stability
- 16-gauge, 1" diameter steel legs • Full 360° rotation
- Powder-coated black Santex
- Optional casters are available



OJ973



OJ974



OJ975

Model No.	Upholstery Seat	Seat Dimensions"	Wt lbs.
OJ973	Vinyl & Foam-Padded Seat & Back	19 x 17	33
OJ974	Polyurethane Seat & Back	18 x 17	33
OJ975	Premium Self Skinned Polyurethane Seat & Back	19 x 18	35
OJ976	Optional Set of 5 Tile Casters (Includes Leg Insert Socket)		

SHOPTECH ERGONOMIC INDUSTRIAL STOOLS



- Industrial seating that brings ergonomic comfort and productivity to the shop floor, the laboratory or the shipping office
- Durable, easy to clean, molded polyurethane seating is the perfect solution for clean rooms or wipe down applications
- **OE088** has an overall height of 16 to 21 1/2" with a 19" W x 14" D seat
- **OE089** sit/stand stool has an overall height of 19 to 26 3/4", seat is 19" W x 14" D with a 6" W x 5" H back



Model No.	Description	Wt. lbs.
OE088	Stool	20
OE089	Sit/Stand	19

ERGONOMIC INDUSTRIAL SHOP SEATING

- Industrial chairs featuring comfortable and supportive seating that is easy to clean
- Seats made of a soft molded polyurethane material, backs formed to support the body for greater comfort and less fatigue
- Adjustable back rest
- Nylon base with dual wheel hard floor casters
- Optional chrome foot ring
- Glides recommended with foot ring
- Model **OC816** and **OC821** task chairs have adjustable backrest height, depth and angle
- Optional stool kit model **OC822**



Model No.	Description	Adjustable Height"	Overall Dimensions			Wt. lbs.
			W"	x D"	x H"	
W/CASTERS						
OC815	Operator's Chair	27 to 32-1/2	21	x 20-1/2	x 32-1/2	25
OC816	Task Chair	27 to 32-1/2	21	x 20-1/2	x 32-1/2	26.5
NH450	Operator's Chair w/Stool Kit	34 to 44	21	x 20-1/2	x 44	30
NH451	Task Chair w/Stool Kit	34 to 44	21	x 20-1/2	x 44	31.5
W/GLIDES						
OC820	Operator's Chair	27 to 32-1/2	21	x 20-1/2	x 32-1/2	25
OC821	Task Chair	27 to 32-1/2	21	x 20-1/2	x 32-1/2	26.5
NH452	Operator's Chair w/Stool Kit	34 to 44	21	x 20-1/2	x 44	30
NH453	Task Chair w/Stool Kit	34 to 44	21	x 20-1/2	x 44	31.5

DRAFTING STOOLS

- Designed with a contoured seat and back
- 3-way back adjustment provides user comfort
- Seat and back are made with a solid 3/4" plywood frame
- Standard 100% polypropylene black fabric upholstery
- One piece durable plastic base with chrome footrest
- Two pneumatic gas levers simplify height adjustment from 23" to 33" and ergonomic tilt
- With casters

Model No. OA286



INDUSTRIAL & OFFICE SEATING

1405 & 1410 PREMIUM SERIES CHAIRS

- Task and operator chair
- Molded foam cushions
- "One-touch" ergonomic chair controls
- Gas lift height adjustment
- Back height and depth adjustment
- Seat and back angle adjustment on 1410 Series
- Optional arms and stool kit available
- Dual wheel carpet casters

Black Onyx



Charcoal



OE744



OE748

Model No.		Description	Seat Dimensions			Back Dimensions	
Black Onyx	Charcoal		W"	D"	H"	W"	H"
OE744	OE745	1405 Series chair	18-1/2	x 22	x 32-36 3/4	16 1/2	x 14
OE746	OE747	1405 Series w/stool kit	23-1/2	x 22	x 39 1/2-44 1/4	16 1/2	x 14
OE748	OE749	1410 Series multi functional	24-1/2	x 23 1/2	x 33-38 1/2	17 1/2	x 15

TASK CHAIRS & ECONOMICAL STENO CHAIRS

- Pneumatic height adjustments
- Backrest height adjustments
- Five prong nylon base
- Dual wheel carpet casters
- Stool kit available
- Optional arms
- Optional glides (recommended with stool kit)

Black Onyx



Charcoal



OC312



OE095

Model No.		Description	Seat Dimensions			Back Dimensions			Wt. lbs.
Black Onyx	Charcoal		W"	D"	H"	W"	H"		
ECONOMICAL STENO CHAIRS									
OC310	OC309	w/o arms	20-1/4	x 23	x 28 1/2-36	16 1/2	x 11 1/2	30	
OC312	-	w/T-arms	25-1/4	x 23	x 28 1/2-36	16 1/2	x 11 1/2	32	
OE093	OE092	w/stool kit	20-1/4	x 23	x 36-41	16 1/2	x 11 1/2	35	
TASK CHAIRS									
OE095	OE094	w/stool kit	23-1/2	x 22	x 40-45 1/2	17 1/2	x 15	35	

OPTIONS FOR CHAIRS

Model No. OA271
Loop Arm Kit
(width adjustable)



Model No. OC323
T-Arm Kit (width & height adjustable)



Model No. OA269
Stool Kit



ACTIV® A-43 MID-BACK MESH-CHAIRS

- Tilt mechanism with lockout feature and tension adjustment
- Height and depth adjustable lumbar support
- Optional height and tilt adjustable headrest
- Adjustable height: 39 1/2" to 42 1/2"
- Back: 22" H x 19 1/2" W
- Seat: 19 1/2" W x 19 1/2" D
- Chair overall dimensions: 25 3/4" W x 23" D x 42 1/2" H
- Height and width adjustable armrests
- Fabric: Standard black
- Black base and gas cylinder
- Custom upholstery available



Model No.	Description
OK208	Mid Back Mesh-Chair
ON573	Head Rest

ACTIV® SERIES A-96 MESH CHAIRS

- Flexibly adjusts to support your back as you move in your seat while working
- Allows airflow to your back to keep you cool and comfortable
- Feels soft and comfortable, not rigid, against your back
- Mesh contoured shaped back
- Black fabric on seat
- Pneumatic seat height adjustment between 37" to 40"
- Seat: 9 1/4" W x 20" D
- Backrest: 19 1/2" H x 18" W
- Overall dimensions: 25 1/4" W x 21 3/4" D x 40" H
- Fixed armrests
- Tilt feature with lockout
- Tension adjustment
- Chrome base and gas cylinder
- Carpet caster



Model No. OK210

ACTIV® A-618 LEATHER MANAGER'S CHAIRS

- Thick padded and contoured seat and back for superior comfort
- Seat: 21 3/4" W x 21" D
- Backrest: 24" H x 21 1/2" W
- Overall dimensions: 25 1/4" W x 21 1/2" D x 46" H
- Back features built-in lumbar support which allows increased relaxation of the back
- Contoured armrests for increased support
- Pneumatic seat height adjustment from 43" to 46"
- A tilt mechanism with lockout
- Tension adjustment
- Contoured backrest shaped to fit the contours of the body
- Soft-touch leather like fabric



Model No. OK390



INDUSTRIAL & OFFICE SEATING

ACTIV™ A-20 GUEST CHAIR

- Breathable mesh back
- Padded seat for comfort
- Seat Width: 18.5"
- Seat Depth: 19.5"
- Backrest Height: 16"
- Weight Capacity: 250 lbs.
- Overall Dimensions: 22-1/4" W x 22-1/2" D x 34-1/2"

Model No. OP794



POLYPROPYLENE FOLDING CHAIRS

- Durable contoured back and seat for all day comfort
- Steel framing and folding legs for extra strength
- Easy to clean
- Dimensions: 15 1/2" L x 16 1/2" W x 33 1/2" H
- Capacity : 350 lbs.



Model No	Colour
ON602	White
OP448	Black
OP449	Blue

ECONOMY DRAFTING CHAIRS

- Pneumatic seat height control adjusts from 23" to 33"
- Manual back height and depth adjustment
- Chrome-plated adjustable footring
- Five-star nylon-reinforced base for strength and durability
- Back dimensions: 16" W x 9 1/2" H
- Seat dimensions: 18 3/4" W x 16 5/8" D



Model No.	Colour	Wt. lbs.
OE096	Black	25

STAG4 ERGONOMIC SEATING

- Ergonomic seat allows user to work in a kneeling position with comfort
- Reduced pressure sensations felt in the knees, ankles and lumbar region
- 1-lever mechanism for seat height adjustment and 20° adjustable slope for kneeling position
- Padding: Dual-density cushions, closed-cell foam
- Upholstery for standard unit: Easy to maintain black/grey moburg and naugahyde, antibacterial, antistatic material
- For welding unit: Flame retardant natural cow suede
- Standard pneumatic lift: 17.5" to 22.5"
- Dimensions:
 - Knees: 8.5" W x 15.5" D
 - Seat: 12.5" W x 12" D
 - Steel base: 21" x 27"
- Five 3" caster wheel adaptable to all surfaces
- Includes small tool tray



Synetik

ErgoDesign

Model No	Description
OG347	Ergonomic Bench
OG348	Ergonomic Bench w/Welding Fabric



TF180 ERGONOMIC INDUSTRIAL STOOLS

- An ergonomic stool with a larger seat improving workers comfort
- Standard pneumatic lift: 20.5" to 28.25"
- Dimensions:
 - Seat: 17.5" W x 14" D
 - Backrest: 12" W x 14" H
- Mechanism: three levers seat height adjustment, tilting seat, and tilting backrest
- Padding: Dual-density cushions, closed-cell foam
- Base: 28" diameter, steel
- Five 3" caster wheels adaptable to all surfaces



Synetik

ErgoDesign

Model No	Description
OP241	Ergonomic Industrial Stool
OP242	Ergonomic Stool w/Welding Fabric



HEAVY-DUTY STEP STOOLS

- Comes with a double platform with non-slip rubber tread
- Spring-loaded casters retract under slight pressure, forcing base to the floor
- 11" diameter upper platform and 13 1/2" diameter lower platform
- 17 1/4" diameter base has an all-around protective bumper
- 16 1/2" overall height
- Capacity: 500 lbs.
- Wt.: 10 lbs.

Model No. ON528



STEP STOOLS

- Tough 1-piece poly construction with anti-skid bottom
- Threaded top and expanded step
- 16" diameter base provides added stability
- Glides easily on retractable rubber casters
- 13" overall height
- Capacity: 350 lbs.
- Wt.: 7 lbs.

OA300



Model No.	Mfg. No.	Colour
OA299	2523BL	Black
OA300	2523BE	Beige



IPAD® HOLDER & COMPUTER EQUIPMENT

IPAD® HOLDER

- Compatible with iPad® models 2, 3, 4 and iPad® Air
- Lock and key secured case for tablet
- Provides home button accessibility
- Interior cable management
- 90° rotation and 75° tilt adjustable
- Ideal for use in education, health-care, corporate, retail and point of sale environments
- Base Material: Steel



ANTI-THEFT

- Steel base includes mounting holes for bolts for fixed application (bolts not included)

Model No.	Height"
OP808	49.25
OP810	17.5

PORTABLE & FREE STANDING

Model No.	Height"	Base Dimensions (mm)
OP809	49.25	300 x 400
OP811	17.75	200 x 300

ACTIVERGO™ MONITOR ARM

- Reach: 16.75"
- Weight Capacity Per Arm: 17.6 lbs. (8 kg.)
- Frame: Steel and aluminum structure
- Finish: Silver
- Cost-effective and ergonomic alternative for monitor support
- Extend, tilt and swivel your monitor up to 90° left and right for easy viewing
- Tilt motion makes it easy to reduce glare
- Clamp and grommet mount are included
- Features cable management clips
- Fits most 13" to 27" monitors
- VESA standard mounts for monitors (75 and 100 mm)
- Warranty: 5 year



Model No.	No. of Screens
OP802	1
OP803	2

GOYA™ SIT-STAND WORKSTATION

- Transforms any seated desk into a sit-stand workstation
- Easily adjustable due to gas assisted lift mechanism
- Adjustable keyboard surface tilts
- Can accommodate both clamp and grommet mount monitor arms
- Colour: Black
- Weight Capacity: 35 lbs.
- No assembly required



Model No.	Overall Dimensions W" x D" x H"
OP807	35-2/5 x 24 x 20

MOBILE COMPUTER CABINETS

- All-steel welded construction
- Top monitor compartment is 22 1/2" W x 23" D x 18 3/4" H with a slide-out keyboard shelf
- Locks independently of bottom section which includes two adjustable shelves
- 5" polyolefin casters (two rigid, two swivel w/brake)
- **Includes:** Vented back for air circulation and a 6-outlet power strip with built-in surge suppression
- Overall dimensions: 26" W x 24" D x 64" H
- Weight: 149 lbs.
- Durable baked enamel blue and light grey finish
- Shipped fully assembled

Model No. OC532



MOBILE SECURITY COMPUTER CABINETS

- Secure locking cabinet with resistant acrylic see-thru window for LCD monitor
- Slide-out locking keyboard is 19 3/4" W x 17 1/2" D x 4" H
- Lower compartment is 20 1/2" W x 21" D x 23 1/2" H and has a locking front and rear access doors
- Two convenient side wing shelves for additional work space, fold down when not required
- 5" heavy-duty casters (two rigid, two swivel w/brake)
- Overall dimensions: 24 1/2" W x 22 1/2" D x 62 1/4" H
- Powder coat finish provides a durable finish

Model No.	Colour
OG880	Blue
OG882	Light Grey



MOBILE COMPUTER CABINETS

- All-steel construction
- Slide-out keyboard tray
- Lower lockable cabinet is 24 5/8" W x 22 7/8" D x 22 5/8" H
- 2-position shelf can be located for desk top style or up to 18" H tower style CPU's
- Fixed shelf is 24 5/8" W x 22 7/8" D x 11 1/2" H and provides ample room for any sheet fed style or continuous form style printer
- Rear cabinet access holes for paper feed, cables and ventilation fan (not included)
- 5" polyolefin casters (two rigid, two swivel w/brake)
- Overall dimensions: 27" W x 24" D x 49 1/4" H
- Blue
- Weight: 125 lbs.
- Shipped knocked down, assembly required with simple hand tools

Model No. OC839



COMPUTER CABINETS

- A unique 2-piece heavy-duty all-welded steel construction that provides space efficient security for your valuable electronic equipment
- Locking upper compartment with plexiglass window provides viewable access for most 20" monitors
- Lower compartment features one fixed bottom and one adjustable shelf
- Top level can be bolted onto a desk (bolts not included)
- Louvers in the rear provide equipment ventilation
- Heavy-duty all-welded steel top and bottom sections bolt together for easy assembly
- **Includes:** 5" casters (two rigid, two swivel w/brake)

OE825



Model No.	Description	Dimensions			Colour
		W"	D"	H"	
OE824	Complete Enclosure w/Casters	24 1/2	x 22 1/2	x 59 1/2	Light Grey
OE825	Complete Enclosure w/Casters	24 1/2	x 22 1/2	x 59 1/2	Putty
OE826	Top Level (Internal)	20 3/4	x 21 3/4	x 19 1/4	Light Grey
OE827	Top Level (Internal)	20 3/4	x 21 3/4	x 19 1/4	Putty

MAIL CARTS & LITERATURE RACKS



WIRE MESH OFFICE MAIL CART

- Ideal for carrying hanging files (letter and legal) mail, packages and tools
- Removable baskets
- 1" diameter, 18 gauge tubular construction
- Shipped Knocked Down
- Colour: Chrome
- Cart Material: Chrome Plated
- No. of Shelves: 2
- No. of Baskets: 2



MO208



MO209



Model No.	Dimensions					Capacity Lbs.
	L"	x	D"	x	H"	
MO208	33	x	20	x	37-1/2	200
MO209	33-1/2	x	23-3/4	x	38-1/4	200
MO210	43	x	23-3/4	x	38-1/2	250

LITERATURE STORAGE RACKS

- Construction is of sturdy heavy gauge steel
- Provide a convenient and compact way to store literature
- Most models accommodate 150 standard 8 1/2" x 11" sheets, while others are wider to hold magazines and special forms



OC553



OA163



OC543



OA148

DURHAM MFG
Est. 1922

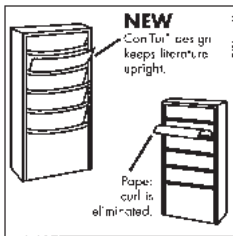

OC540

ROTATING LITERATURE RACKS

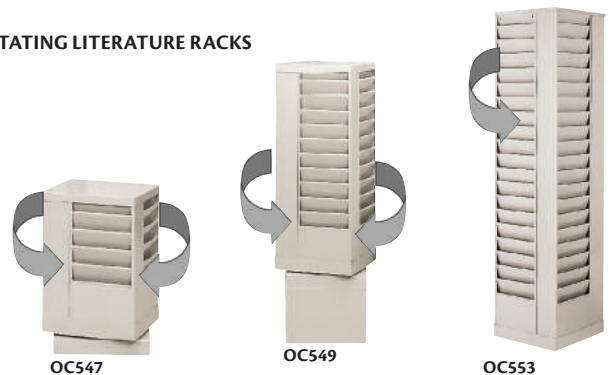

OC547

OC549

OC553

Putty	Model No.			Overall Dimensions			Openings					Paper Width"	No. of Pockets	Wt. lbs.		
	Grey	Tan	Black	W"	x	D"	x	H"	W"	x	D"				x	H"
OC540	OA152	OA130	OC536	9 3/4	x	4 1/8	x	65 1/2	8 5/8	x	3/4	x	8 1/2	8 1/2	23	32
OC559	OA166	OA156	OA607	13 1/8	x	4 1/8	x	58 1/2	12 1/8	x	1	x	8 3/4	12	20	38
OC541	OA161	OA155	OC537	9 3/4	x	4 1/8	x	36	8 5/8	x	3/4	x	8 1/2	8 1/2	11	18
OC558	OA148	OA162	OA125	13 1/4	x	4 1/8	x	36	12 1/8	x	1	x	8 3/4	12	11	24
OC543	OA169	OA165	OC539	9 3/4	x	4 1/8	x	21	8 5/8	x	3/4	x	8 1/2	8 1/2	5	9
OC557	OA163	OA144	OA609	13 1/8	x	2	x	26 1/4	12 1/8	x	5/16	x	5 5/8	12	10	13
ROTATING LITERATURE RACKS																
OC553	OA149	OA179	OC552	14 1/8	x	14 1/8	x	66	8 5/8	x	3/4	x	8 1/2	8 1/2	92	136
OC549	OA134	OA158	OC548	14 1/8	x	14 1/8	x	48 1/2	8 5/8	x	3/4	x	8 1/2	8 1/2	44	92
OC547	OA145	OA128	OC546	14 1/8	x	14 1/8	x	21 1/4	8 5/8	x	3/4	x	8 1/2	8 1/2	20	47

FILING SYSTEMS

VERTICAL FILING SYSTEMS

Ideal for filing blueprints, charts, artwork and other oversized documents. Cuts filing and retrieving time; saves on floor space. Exclusive suspension system allows clamps to slip easily in and out of storage racks. Clamps open to 1" to hold up to 100 individual sheets (20 lbs. maximum weight per clamp).

MOBILE VERTICAL FILES

- All-steel construction with four ball bearing swivel casters (two lock)
- Fits 24" to 36" clamps (order separately)
- Holds up to 12 clamps that simply drop in and lift out
- Maximum capacity is 1200 sheets or 240 lbs.
- Compact economy
- Width adjusts from 27 1/2" to 39 1/4"
- Depth is 16" overall
- Height adjusts from 40" to 52"
- Assembly required
- Weight: 25 lbs.

Model No. OE130



HEAVY-DUTY MOBILE STANDS

- Steel construction with four 3" ball bearing swivel casters (two lock)
- Holds 12 hanging clamps in pivot brackets that swing open for easy access to contents
- Height adjusts from 43 5/8" to 61 5/8" for sheets up to 54" long
- Adjusts from width 27 1/2" to 37 1/2"
- Tropic sand finish
- Assembly required



Model No.	Description	Wt. lbs.
OE129	Mobile Stand Only	47
OA195	Mobile Stand with 12-24" Clamps	61
OA196	Mobile Stand with 12-30" Clamps	63
OA213	Mobile Stand with 12-36" Clamps	65
OA197	Mobile Stand with 12-42" Clamps	67

PRINT-LOCK® HANGING CLAMPS

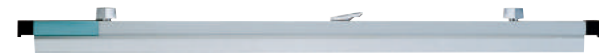

- Clamps hold up to 100 sheets or 20 lbs.
- Green plastic label holders included
- Available in natural aluminum with polished chrome plated cast alloy wing knobs and black end caps



Model No.	Description	Clamp/Pkg.	Wt. lbs.
OE135	18" Long Hanging	6	6
OE136	24" Long Hanging	6	7
OE137	30" Long Hanging	6	8
OE138	36" Long Hanging	6	9
OE139	42" Long Hanging	6	10

KEY STORAGE CABINETS

- Organize and control your office or warehouse with wall-mounted key cabinets
- Heavy gauge steel construction with piano hinged doors and key panels – provide a secure location for key storage
- Industrial 19-gauge body with 18-gauge door on all except OJ922, it has a 20-gauge body and 19-gauge door
- Durable beige powder coat epoxy finish
- All models come with numbered slots and key tags



OJ924

Model No.	Description	Dimensions				
		W"	x	D"	x	H"
OJ922	30-Key Cabinet	8	x	2 1/2	x	12
OJ923	60-Key Cabinet	10 3/4	x	3	x	12 1/4
OJ924	120-Key Cabinet	13	x	3 1/4	x	17
OJ925	240-Key Cabinet	16 1/2	x	5	x	20
OJ927	500-Key Cabinet	18	x	5 1/2	x	25
OJ928	Key Tags – 20/Pack	-				

VERTICAL FILE CABINET

- Letter width vertical file
- Ball bearing suspension for easy opening and closing
- Drawer front features a recessed angled full pull
- Lock included
- Meets or exceeds ANSI/BIFMA

OP916



Model No.	Colour	W"	x	D"	x	H"	No. of Drawers
OP912	Black	15-1/7	x	25	x	29	2
OP913	Black	18-1/7	x	25	x	29	2
OP914	Black	15-1/7	x	25	x	52	4
OP915	Black	18-1/7	x	25	x	52	4
OP916	Grey	15-1/7	x	25	x	29	2
OP917	Grey	18-1/7	x	25	x	29	2
OP918	Grey	15-1/7	x	25	x	52	4
OP919	Grey	18-1/7	x	25	x	52	4
OP920	Beige	15-1/7	x	25	x	29	2
OP921	Beige	18-1/7	x	25	x	29	2
OP922	Beige	15-1/7	x	25	x	52	4
OP923	Beige	18-1/7	x	25	x	52	4

DATA ORGANIZERS

- Horizontal literature rack
- All racks easily bolt together with fasteners provided
- Steel modular, horizontal racks that can be grouped for floor or table mounted storage
- Capacity for literature or directories up to three inches thick
- 8" legs (model CA159) available to raise unit off the floor
- Tan enamel finish
- Includes: Mounting clips

Can be stacked for personalized use!

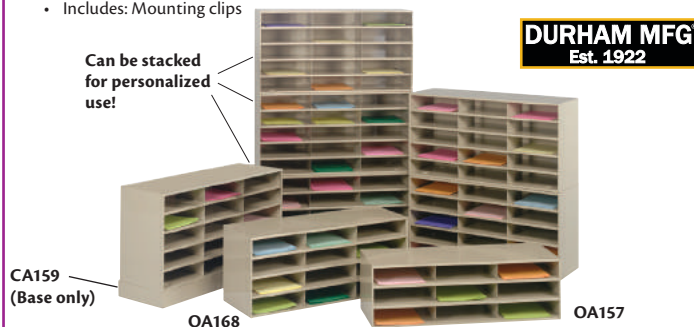

DURHAM MFG
Est. 1922

Specifications	Model OA157	Model OA168	Model CA159
Height "	10 3/4	14 1/4	33 7/8
Width "	33 3/4	33 3/4	3 1/8
Depth "	11 5/8	11 5/8	12 1/8
Opening Width "	11	11	-
Opening Depth "	11 1/2	11 1/2	-
Opening Height "	3	3	-
No. of Openings	9	12	-
Paper Width "	8 1/2	8 1/2	-

COMBINATION BOARD

- Dual-purpose cork/white board provides versatility in getting your message across
- Porcelain whiteboard for a smooth and clear writing surface
- Double-sided cork for added durability
- Ideal for office or warehouse environments
- Plastic-molded corners protect the boards and wall from damage
- Sturdy aluminum frame
- Dimensions: 36" W x 24" H

Model No. OP542

KLETON



PORCELAIN WHITEBOARD

- White magnetic writing surface provides a clean, colourful display
- Porcelain surface is smooth and resistant to staining
- Effortless erasing, wipes clean with cloth or felt brush
- Galvanized steel backing for added durability
- Plastic corners for board and wall protection
- Mounting hardware included
- Style: Magnetic

KLETON



Model No.	Dimensions"
OP534	24 x 18
OP536	48 x 36

POLYETHYLENE FOLDING TABLES

- Blow molded polyethylene top
- Lightweight with folding legs for easy storage
- 29" fixed table height with locking steel legs
- Easy to clean
- Folding legs automatically lock by use of gravity activated mechanism when opened
- Capacity: 500 lbs. for solid table
350 lbs. for fold-in-half table

Chairs (ON602) not included
See page B199



OK137



ON598



Model No.	Description	L"	x	W"	x	H"	Wt lbs.
ON598	Rectangular	48	x	24	x	29	22
ON599	Rectangular	72	x	30	x	29	35
ON600	Rectangular	96	x	30	x	29	50
ON601	Rectangular Fold-in-Half	72	x	30	x	29	36
OK137	Round	48	x	48	x	29	31
OK138	Round	60	x	60	x	29	47

ECONO/STOR® BOXES

- The perfect choice for economical storage of semi-active or dead records
- Recycled material
- **OA081** can be adapted to hold up to one cubic foot of legal or letter size



Model No.	Record Size	Dimensions W" x D" x H"	Stackable Up To
OA082	Letter	12 x 24 x 10	650 lbs.
OA079	Legal	15 x 24 x 10	700 lbs.
OA081	Letter or Legal	12 x 15 x 10	350 lbs.

CORKBOARDS

- Ideal for office or warehouse environments
- Sturdy aluminum frame
- Plastic-molded corners protect the boards and wall from damage
- Double-sided cork for added durability

ON593

KLETON



Model No.	Dimensions"	Wt. lbs.
ON593	18 x 24	3.5
ON594	24 x 36	6
ON595	36 x 48	10.5
ON596	48 x 72	18
ON597	48 x 96	30

CORKBOARD ACCESSORIES

PUSH PINS

Plastic head, assorted colours. 100 per pkg.

Price per package

Model No. OJ472



WHITE BOARDS

- White writing surface provides clean, colourful display
- Effortless erasing, wipes clean with cloth or felt brush
- Aluminum frame
- Plastic corners for board and wall protection

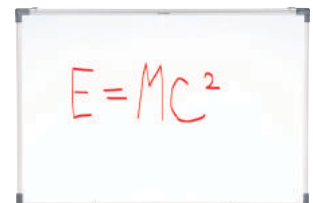

ON531

KLETON

NON-MAGNETIC

MAGNETIC

Model No.	Dimensions"	Wt. lbs.
ON535	24 x 36	6
ON536	36 x 48	10.5
ON537	48 x 72	18

Model No.	Dimensions"	Wt. lbs.
ON530	18 x 24	3.25
ON531	24 x 36	6
ON532	36 x 48	10.5
ON533	48 x 72	18
ON534	48 x 96	30

DURA-INK® DRY ERASE INK MARKERS

- Ideal for white board marking in offices and factories
- Mark can be removed quickly and easily with dry rag, towel, or eraser



Markal
High Performance Industrial Markers

Model No.	Colour
PE773	Red
PE774	Black
PE775	Blue
PE776	Green

CLOCKS

TIME CLOCKS

- Large, easy-to-read analog clock face
- LED display of year, month and date
- Automatic or manual printing
- Print window with light
- Automatically adjusts for Daylight Savings Time, short months, leap year and power outages
- Selectable for 4-digit imprint
- Built-in battery backup



SPECIFICATIONS:

Power Supply: 110/120 AC ±10% (50/60 Hz)
Power Consumption: Normal 3 W, Max. 12 W
Ambient Temperature: 14°F - 113°F (-10°C - 45°C)
Humidity: 10% - 90% (no condensation)
Dimensions: 6 3/4" W x 6 1/4" D x 8" H
 150 x 172 x 165 (mm)
Weight: 6 lbs. (2.7 kg)

Model No.	Description
HN140	English

TIME CLOCK ACCESSORIES

- Card rack is adjusted for standard 8 1/4" long cards
- Fits 25 standard time cards
- Rack is adjustable to accommodate cards of different widths

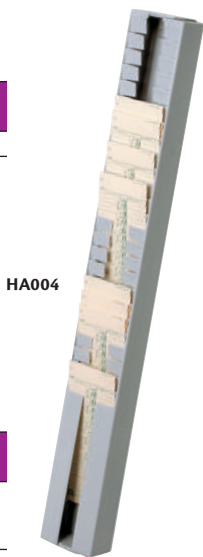

Model No.	Description
HA004	Card Rack
HA001	1000 Time Cards, English
HN141	Replacement Ribbon for HN140 & HN164 Time Clock

WALL CLOCKS

BATTERY OPERATED

- 12" diameter round office wall clock
- 12/24 hour
- Glass face
- Black chrome frame



Model No. HT072

HT072



WALL CLOCK

- Battery operated
- 12-3/4" diameter round office wall clock
- Wall mount
- Plastic face
- Black plastic frame



Model No. OP237

OP237



BATTERY OPERATED

- 14" diameter quartz clock
- Silent quartz movement with second hand
- Use 1 AA battery
- Glass face
- Chrome frame



Model No. HT071

HT071



ATOMIC TIME CLOCKS

- Type of Punch Clock: Digital
- Prints in multiple languages including English and French
- Cartridge ribbon for easy change
- Ribbon Colour: Black
- Illuminated print window and guide improves efficiency on time card stamping
- Locking enclosure prevents tampering with settings and reduces time card fraud
- Ability to synchronize to the atomic clock
- Voltage: 100 - 240 V
- Ambient Temperature: -10°C to 45°C
- Humidity: 10% to 90% (no condensation)
- Unit Dimensions: 5.5" W x 6.9" D x 6.1" H



Model No. OP446

JUMBO ATOMIC WALL CLOCK

- Self-adjusting and self-setting atomic clock
- 7 Languages: English, Russian, Dutch, French, German, Italian, and Spanish
- Display: 12 or 24 hour time format, day, date, indoor temperature, and humidity
- Displays 5" tall clock digit
- Dimensions: 17" W x 1" D x 11" H
- Case Material: Plastic
- Mount Type: Surface/Wall
- Batteries Included: 4 x AA



MARATHON

Model No.	Colour
OP590	Black
OP591	Silver

ATOMIC WALL CLOCK

- Self-adjusting and self-setting atomic clock
- 8 Time Zones: PST, MST, CST, EST, AST, NST, HST, and AKST
- Display: 12 or 24 hour time format with indoor temperature display in Celsius or Fahrenheit
- Easy to read 4" H display
- Option to turn on or off Daylight Savings Time
- Dimensions: 9" W x 1.5" D x 5.7" H
- Case Material: Plastic
- Mount Type: Wall
- Batteries Included: 2 x AA



MARATHON

Model No.	Colour
OP582	Silver
OP583	Brown

JUMBO DIGITAL WALL CLOCK

- Large 17" display
- Visibility from 30' away
- Displays (indoor) temperature in Celsius or Fahrenheit
- Calendar displays month, date and day of the week
- 12 or 24-hour settings
- This wall clock has an atomic self-adjusting feature that picks up time calibration signals automatically
- Clean, brushed-aluminum-look plastic frame
- Mount on your wall or use the built-in stand to place on a flat surface
- Includes three C batteries



MARATHON

Model No. XD075

OASIS WATER COOLERS

Oasis® water coolers are manufactured with a heavy gauge steel frame which provides durable and quiet operation. They feature a 5-year limited warranty on the sealed refrigeration system and most component parts. All waterways are constructed of lead-free materials and HFC 134A is used as a refrigerant. No CFCs are used. All units are standard tan sandstone finish. Drinking water temperature is 50°F/10°C. Certified for sale in Canada by an accredited certification body.

WALL-MOUNTED COOLERS

Units come in standard or compact models. All units are shipped with complete instructions and wall mounting bracket. Units should be installed with the nozzle 36" from the floor.

Model No.	Mfg. No.	Description	GPH Capacity	W"	Dimensions				Wt. lbs.
					x	D"	x	H"	
0J952	PLF4CM	Compact	4	17	x	13 3/16	x	16	51
0A061	P8M	Standard	8	17	x	29 7/8	x	14	73
0A536	P14M	Standard	14	17	x	29 7/8	x	14	76



OA061

COMPACT FREE-STANDING COOLERS

Attractive economical line suitable for applications in offices, shops or factories where space saving is critical.

Model No.	Mfg. No.	Description	GPH Capacity	W"	Dimensions				Wt. lbs.
					x	D"	x	H"	
0A063	P3CP	Compact	3	12	x	12	x	43 3/4	66
0A064	P5CP	Compact	5	12	x	12	x	43 3/4	69
0A548	P10CP	Compact	10	12	x	12	x	43 3/4	73



OA063

AGAINST-A-WALL OR FREE-STANDING COOLERS

All plumbing connections are completely sealed within the cabinet, permitting flush-to-wall installation.

Model No.	Mfg. No.	Description	GPH Capacity	W"	Dimensions				Wt. lbs.
					x	D"	x	H"	
0C709	P8FA	Standard	8	17	x	14	x	43 3/4	94
0A550	P14FA	Standard	14	17	x	14	x	43 3/4	96



OC709

BARRIER-FREE WHEELCHAIR COOLERS

- Designed specifically for easy access
- Wheelchairs fit under edge of water basin for comfort and convenience
- Instructions and wall mounting brackets included
- Drinking water temperature 50°F



Model No.	Mfg. No.	Bubbler Valve Type	GPH Capacity	W"	Dimensions				Wt. lbs.
					x	D"	x	H"	
0A059	P8AC	3 Electric Push Bars	7.8	17 1/2	x	18 1/2	x	22 11/32	54



OA059

DRINKING WATER FILTER FOR OASIS® COOLERS

- Removes dirt, cloudiness, particles, unpleasant odours and taste
- Reduces chlorine by 97%, lead between 95.9% and 99% and cryptosporidium and giardia cysts by 99.99%
- Works with all the Oasis® water coolers listed on this page
- Fast and easy-to-change refill cartridges with automatic shut-off valve inside the filter
- Designed to last 1500 gallons or approximately six months
- Includes: Brackets, complete filter and colour-coded waterline connections

Model No. OG445 Filter
Mfg. No. 033926-002

Model No. OG446 Refill cartridge
Mfg. No. 033879-001



INDUSTRIAL WATER COOLERS

- Heavy-duty blow-molded resin resists chips and dents in the toughest work area or job site
- Injection grade insulated liner material keeps your water or beverage cold
- Leak-resistant screw on lid
- Drip-resistant spigot
- Sturdy molded-in handles on the 10-gallon
- Universal cup dispenser is available for 3 gallons and up, holds 200 cups

NI653



Model No.	Mfg. No.	Description	Wt. lbs.
NI653	FG16830111	3 Gallons	5.4
ON611	1840999	5 Gallons	7.5
ON607	1841106	5 Gallons with Dispenser	7.5
NI656	FG16100111	10 Gallons	10.9
NI657	FG825706	Universal Cup Dispenser	0.82

RUNNER & ENTRANCE MATTING

STANDARD CORRUGATED VINYL NO. 381

THE MOST POPULAR RUNNER MAT!

- Protects floors from foot traffic or special events
- Adds traction where needed
- Reduces cleaning costs
- Flexible, yet durable vinyl compound easily rolls up after use
- Will not curl or shrink during use and is resistant to many chemicals and cleaning fluids
- 1/8" thick
- Colour: Black

The all-purpose runner that makes floors safer to walk on!

NB374

1-YEAR WARRANTY



Model No.	Dim.			Wt. lbs.
	W'	x	L'	
NB374	3	x	105	230
NB376	4	x	105	300

SCRAPER MATS

- Scrape shoes and boots clean to avoid tracking dirt, slush, and snow
- Durable rubber mat resists harsh weather conditions
- Numerous rubber fingers are ideal for trapping dirt
- Beveled edging to help prevent tripping
- Easy to clean
- Type: Scraper
- Thickness: 1/2"
- Colour: Black
- Material: Rubber
- Traffic: Heavy
- Surface Pattern: Textured

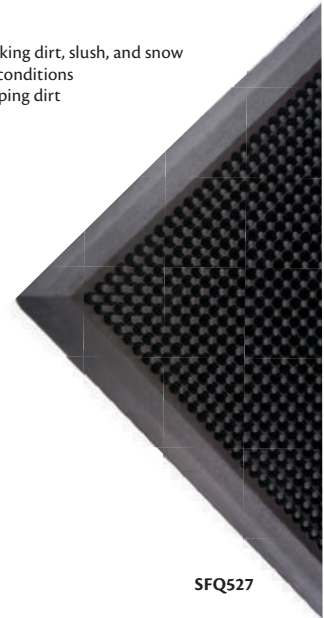

SFQ527



Model No.	Dim.		
	W'	x	L'
SFQ527	2	x	2-2/3
SFQ528	2-2/3	x	3-1/4
SFQ529	2-1/3	x	3-5/6
SFQ530	3	x	5
SFQ531	3	x	6

SCRAPER MATS

- Scrapes shoes and boots clean to avoid tracking dirt, slush, and snow
- Durable rubber mat resists harsh weather conditions
- Low profile design, 5/16" thick
- Easy to clean
- Available with slots to facilitate drainage
- Colour: Black



SDL872

SDL871



Model No.	Description	Dim.		
		W'	x	L'
SDL871	Solid	3	x	5
SDL872	Slotted	3	x	5

BOOT SCRAPER

- Scrape shoes and boots clean to avoid tracking dirt, slush, and snow
- Rubber fingers brush the sides and bottom of boots
- Portable or can be made fixed (mounting hardware not included)
- Easy to clean
- Overall Length: 12"

Model No. SFQ526



ERGONOMIC MATTING

RUNNER MATS

- Fine ribbed rubber runner mats
- Durable rubber mat resists harsh weather conditions
- Easy to clean
- Adds traction to any entrance
- Thickness 1/8"
- Colour: Black



SDL875

Model No.	Dim.		
	W'	x	L'
SDL875	2	x	75
SDL876	3	x	75
SDL877	4	x	75
SDL878	2	x	lin.ft.
SDL879	3	x	lin.ft.
SDL880	4	x	lin.ft.

ENDURABLE NO. 459

Longer-wearing two-in-one construction



- This PVC sponge has a remarkably durable and abrasion resistant surface
- Created during the manufacturing process, its heat bonded to a comfortable sponge base
- As a dual density anti-fatigue mat, lasts much longer than similar products, but is very economical
- All edges are safety bevelled
- 1/2" thick
- Colour: Black

Longer wearing, two-in-one construction!

1-YEAR WARRANTY



WEARWELL

Model No.	Dim.			Wt. lbs.
	W'	x	L'	
NG593	2	x	3	4.5
NG596	2	x	60	90
NG594	3	x	5	11.25
NG595	3	x	12	27
NG597	3	x	60	135
NG598	4	x	60	217

ULTRA-TRED ARMORCOTE NO. 440

NB533

A urethane-coated, PVC sponge anti-fatigue mat

- Urethane coating gives this anti-fatigue mat extra durability
- PVC sponge with a urethane wear-layer for longer performance
- The double-thick urethane coating offers more abrasion and chemical resistance than comparable sponge products
- Ideal for use in mostly dry applications such as labs and other medium traffic areas
- 3/8" thick
- Colour: Black with yellow safety borders

Urethane coating increases durability, resistance to chemicals & clean-up ease!

1-YEAR WARRANTY



WEARWELL

Model No.	Dim.			Wt. lbs.
	W'	x	L'	
NB533	2	x	3	5
NB537	3	x	5	11
NB534	3	x	12	27
SAJ811	2	x	60	83
NB538	3	x	60	135
NB540	4	x	60	160

TUF SPONGE NO. 451 & DELUXE TUF SPONGE NO. 442

NB550

TOP QUALITY PVC SPONGE MATTING!

- For use in all dry work areas
- Blown-PVC sponge designed to reduce floor hardness up to 50%
- Available in workstation mats and rolls, they can easily be "custom" cut to fit your work areas
- Available in two thicknesses:
Tuf Sponge is 3/8" thick
Deluxe Tuf Sponge is a softer formulation and a full 5/8" thick
- Both are available in widths up to 6' with all edges safety rounded on full rolls and stock sizes

Comfort & practicality all rolled into one mat!

1-YEAR WARRANTY



COLOURS:

Tuf Sponge: Black and grey
 Deluxe Tuf Sponge: Black

TUF SPONGE NO. 451

Model No.	Dim.	Wt. lbs.	
		Black	Grey
NB550	2 x 3	5	5
NB565	3 x 5	12	12
NB568	3 x 60	126	126

DELUXE TUF SPONGE NO. 442

Model No.	Dim.			Wt. lbs.
	W'	x	L'	
SAL174	2	x	3	6
SAL180	3	x	5	17

ERGONOMIC MATTING

ERGODECK® ERGONOMIC FLOORING SYSTEMS NO. 560 & NO. 562

- Professional grade 18" x 18" super-sized ergonomic tiles quickly assemble to cover large and custom-sized areas
- Patented LockSafe® system securely connects tiles
- Covers up imperfections and safety hazards
- ErgoDeck™ tiles can be unlocked and repositioned to create a different configuration when work flow changes
- Optional 6" wide safety ramps and corners accommodate carts and have countersunk holes so ErgoDeck® can be attached to the floor
- 7/8" thick
- Designed specifically for heavy cart traffic with load capacity of 64 PSI
- Available in open grid and solid tile designs



ERGODECK® HEAVY-DUTY OPEN GRID NO. 560

- For use in wet (non-greasy) or dry areas where small debris or fluids are present

ERGODECK® HEAVY-DUTY SOLID NO. 562

- For use in dry areas where small parts fall to the floor, or where ease of maintenance is a priority

LIFETIME WARRANTY

SAL217



Outside corner

SAL219

Ramp



SAL224



Model No.	Description	Dim. W" x L" x D"
SAL215	Open Grid No. 560, Single Tile	18 x 18 -
SAL224	Solid No. 562, Single Tile	18 x 18 -
RAMP & CORNER ACCESSORIES		
SAL219	Ramp - Yellow, Single	6 x 18 -
SAL217	Outside Corner - Yellow, Single	6 x 15 x 15

ERGODECK® GENERAL PURPOSE NO. 564 & NO. 566

- Specifically designed to increase worker productivity
- Has a box-spring foundation that flexes to provide anti-fatigue benefits
- Professional grade 18" x 18" super-sized ergonomic tiles quickly assemble to cover large and custom-sized areas
- Patented LockSafe® system securely connects the tiles for a neat installation to withstand heavy use and cart traffic
- Tiles can be unlocked and repositioned to create different configurations
- Optional 6" wide safety ramps and corners
- 7/8" thick
- Colour: Charcoal

LIFETIME WARRANTY



Model No.	Description	Dim. W" x L"	Qty /Case
SAQ312	Open Grid No. 564, Case	18 x 18	10
SAQ313	Solid No. 566, Case	18 x 18	10
RAMP & CORNER ACCESSORIES			
SAL219	Ramp - Yellow, Single	6 x 18	-
SAL217	Outside Corner - Yellow, Single	15 x 15	-

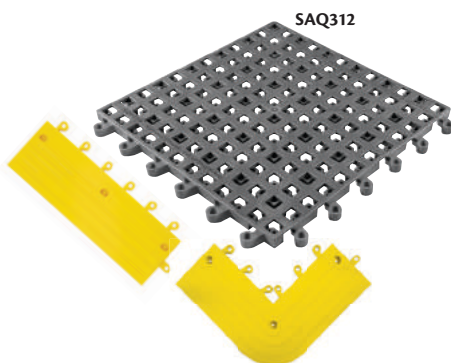

SAQ312

ANTI-FATIGUE LINK MATS

- Designed to help prevent injuries and increase worker comfort
- Modular interlocking designing on all four sides permits coverage of large floor spaces
- Recommended for wet and dry environments
- Lightweight and easy to clean
- Thickness: 1/2"
- Dimensions: 3'x3'
- Optional black and yellow border ramps to prevent ripping

SDL865

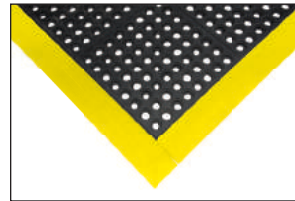

With ramp SDL870

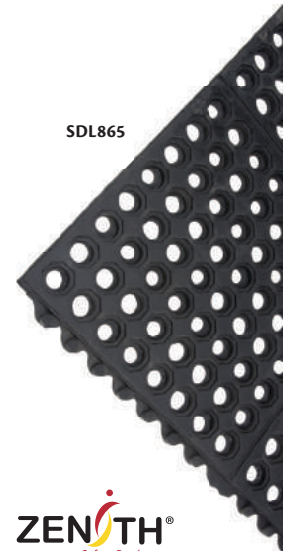

MATS

Model No.	Description	Material
SDL865	General Purpose	Natural rubber
SDL866	Grease Proof	50% nitrile rubber/50% natural rubber

BORDER RAMPS

Model No.	Connection	Colour
SDL867	Male	Black
SDL868	Female	Black
SDL869	Male	Yellow
SDL870	Female	Yellow

ERGODECK® ERGONOMIC FLOORING SINGLE TILE NO. 590

- Professional grade 18" x 18" super-sized ergonomic tiles quickly assemble to cover large and custom-sized areas
- The patented LockSafe® system securely connects the tiles for a neat, clean, installation that will withstand heavy use and cart traffic
- The incredibly substantial design creates a floor above the facility floor, covering up imperfections and safety hazards
- ErgoDeck® tiles can be unlocked and repositioned to create a different configuration when work flow changes
- Optional 6" wide safety ramps and corners accommodate carts and have countersunk holes so ErgoDeck® can be attached to the floor
- Environment: Oily/Wet/Dry
- Surface Type: Diamond
- Colour: Charcoal
- Material: PVC
- Style: Solid
- Thickness: 7/8"
- Length: 1-1/2'
- Width: 1-1/2'



Model No.	Description
JH629	Single Tile
JH630	10 Tiles



ERGONOMIC MATTING

DIAMOND-PLATE NO. 414 & 415

- These mats have a Nitricell® sponge base, a unique and resilient nitrile rubber composite that provides unparalleled comfort, resilience and long-term performance
- The PVC diamond-plate surface resists abrasion and most chemical spills
- Safety bevelled edges

UltraSoft Diamond-Plate No. 414: Ultimate Performance has a double-thick Nitricell® sponge base for a little extra comfort

Diamond-Plate SpongeCote No. 415: Best Performance is a standard 9/16" thick and has been a best seller for over 20 years!

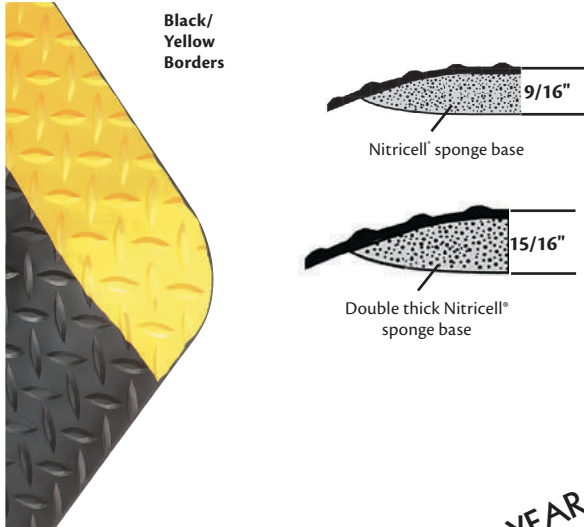

Black/
Yellow
Borders

Nitricell® sponge base

Double thick Nitricell®
sponge base



WEARWELL

1-YEAR
WARRANTY

NO. 414

Model No.	Dim. W'	x	L'	Wt. lbs.
15/16" BLACK/YELLOW				
SAJ810	2	x	3	9
NG924	3	x	5	21
15/16" BLACK				
SAJ809	2	x	3	9
NG917	3	x	5	21

NO. 415

Model No.	Dim. W'	x	L'	Wt. lbs.
9/16" BLACK/YELLOW				
NB416	2	x	3	8
NB430	3	x	5	18
9/16" BLACK				
NB420	2	x	3	8
NB431	3	x	5	18

SMART DIAMOND-PLATE NO. 497

- An economical and green solution for preventing worker fatigue
- Diamond-plate surface with a 100% recycled urethane composite sponge base
- Green rating > 80% recycled
- Comfortable and functional in dry industrial applications
- Black and black with yellow borders



WEARWELL

1-YEAR
WARRANTY

An economical and
GREEN solution for
preventing worker fatigue.

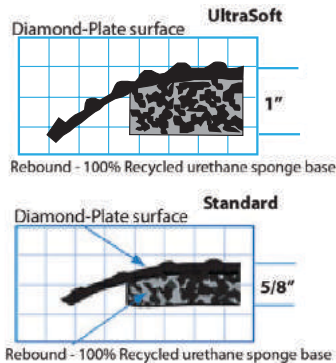

Rebound - 100% Recycled urethane sponge base.

Rebound - 100% Recycled urethane sponge base.

Model No.	Dim. W'	x	L'	Model No.	Dim. W'	x	L'
1" BLACK				5/8" BLACK			
SBA878	2	x	3	SBA894	2	x	3
SBA879	3	x	5	SBA895	3	x	5
1" BLACK W/YELLOW				5/8" BLACK W/YELLOW			
SBA886	2	x	3	SBA902	2	x	3
SBA887	3	x	5	SBA903	3	x	5

* Cuts up to 75' in length available

DIAMOND-PLATE WITH GRITWORKS!® NO. 416

- Ideal for primarily dry areas with slight overspray or where grease and oil get tracked onto the mat
- Carbide grit that increases traction by over 50% while also increasing the chemical resistance and durability of the surface
- Super resilient, Nitricell® sponge base which is PVC loaded with nitrile rubber
- Exceptional comfort, rebound and long life
- All mats come with safety-beveled edges
- Colour: Black

3-YEAR
WARRANTY



WEARWELL

NO. 416

Model No.	Dim. W'	x	L'
STANDARD 9/16"			
SAL632	2	x	3
SAL634	3	x	5
SAL638	3	x	75

Model No.	Dim. W'	x	L'
ULTRASOFT 15/16"			
SAL633	2	x	3
SAL635	3	x	5
SAL639	3	x	75

Cuts up to 75' in length available

Carbide grit increases
traction by over 50%

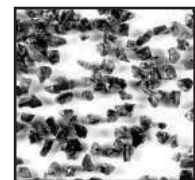

STANDARD

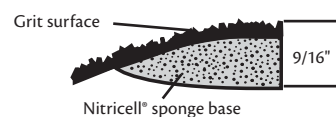

ULTRASOFT

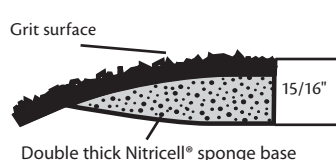

ERGONOMIC MATTING

DIAMOND-PLATE SELECT NO. 495

- Uniquely comfortable, resulting in productive, focused employees
- An excellent anti-fatigue mat designed to increase comfort and relieve stress; it's popular in dry industrial, lab and commercial applications
- The specially formulated, PVC Flex-Link™ sponge base is compounded for enhanced functionality
- Green rating > 50% post consumer material
- Colours: Black with yellow borders
- Available in two thicknesses:

Standard:

Overall thickness: 9/16"
Sponge thickness: 3/8"

Ultra thick:

Overall thickness: 15/16"
Sponge thickness: 3/4"
(designed for extra softness)

SAL349

1-YEAR
WARRANTY



Model No.	Dim.			Wt lbs.
	W'	x	L'	
9/16"				
SAL349	2	x	3	8
SAL358	3	x	5	18
SAL361	3	x	75	244
15/16"				
SAL201	2	x	3	9
SAL207	3	x	5	21
SAL209	3	x	75	338

Available in cuts up to 75' in length

SMART TILE-TOP NO. 496

- A SMART solution to standing worker fatigue, this mat is economically priced and "green"
- Priced like a sponge mat, yet wears five times longer
- The resilient sponge base - Rebound – is a 100% recycled urethane composite
- Comfortable and functional in dry industrial, lab or commercial applications
- Available in two thicknesses:
 - Standard** – 1/2" thick
 - UltraSoft** – 7/8" thick designed for even greater comfort
- Green rating > 80% recycled

A smart solution to standing worker fatigue, this mat is economically priced and **GREEN**.



1-YEAR
WARRANTY

Model No.				Dim.		
Black	Grey	Blue	Charcoal	W'	x	L'
1/2" THICK						
SBA910	SBA926	SBA942	SBA958	2	x	3
SBA911	SBA927	SBA943	SBA959	3	x	5
7/8" THICK						
SBA918	SBA934	SBA950	SBA966	2	x	3
SBA919	SBA935	SBA951	SBA967	3	x	5

Cuts up to 60' in length available

ANTI-FATIGUE DOME MATS

- Designed to help prevent injuries and increase worker comfort
- Raised dome design increases circulation in the users legs through subtle posture changes resulting in less stress
- Beveled edging to help prevent tripping
- Recommended for dry work environments
- All mats are 1/2" thick, natural rubber
- Colour: Black

SDL858



SINGLE MATS

Model No.	Dim.			Border colour
	W'	x	L'	
SDL857	2	x	3	Black
SDL858	2	x	2	Yellow
SDL859	3	x	4	Black
SDL862	3	x	4	Yellow

MODULAR MATS

Model No.	Dim.			Description	Border colour
	W'	x	L'		
SDL860	3	x	4	Center	Black
SDL861	3	x	4	End	Black
SDL863	3	x	4	Center	Yellow
SDL864	3	x	4	End	Yellow

ANTI-FATIGUE MAT

- Designed to help prevent injuries and increase worker comfort
- Recommended for wet and dry environments
- Lightweight and easy to clean
- Modular interlocking design on all four sides permits coverage of large floor spaces
- Optional black and yellow border ramps to prevent tripping
- Surface Type: Smooth
- Environment: Wet/Dry
- Material: Natural Rubber
- Style: Solid
- Colour: Black
- Thickness: 1/2"



Model No.	Description	Dim.		
		W	x	L
SDS622	Anti-Fatigue	3'	x	3'

ERGONOMIC MATTING

WELDSAPE® NO. 447

- Dramatically reduces fatigue while withstanding the challenges of welding environments
- Specially formulated to repel sparks and hot metal shards, the thick rubber surface has a melt point of over 500°F
- The super resilient Nitricell® sponge base is a nitrile rubber composite that offers unparalleled comfort
- All edges are safety bevelled
- Green rating > 33% post industrial material
- Colour: Black
- 1/2" thick



NG181

Anti-fatigue mat specifically designed for welding!

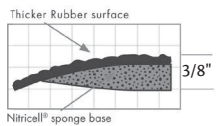

Model No.	Dim.			Wt. lbs.
	W'	x	L'	
NG181	2	x	3	9
NG182	3	x	5	23

Available in other lengths, call for a quote

WORKSAFE® LIGHT NO. 478 CFR

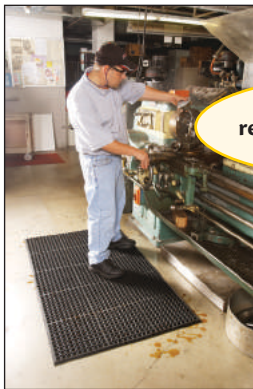

A NEW compound resistant to mineral oil based cutting fluids.

1-YEAR WARRANTY

- This best-selling, lightweight, high performance drainage mat is now resistant to mineral oil based cutting fluids
- The new CFR (Cutting Fluid Resistant) formulation is perfect for wet industrial areas
- Its lightweight design eases the strain of clean-up, yet keeps employees quite comfortable
- WorkSafe® Light is 1/2" thick with molded beveled edges for easy access
- A well-engineered drainage system that keeps debris from becoming trapped



Model No.	Description	Dim.		
		W'	x	L'
NB632	-	3	x	5
NB630	-	3	x	10
NB631	-	3	x	20
SAL221	Connector	-	-	-

DRAINAGE MATS

- Designed to help prevent injuries and increase worker comfort
- Resistant natural rubber is recommended for both wet or dry work
- Beveled edging to help prevent tripping
- Easy to clean
- Material: Natural Rubber
- Environment: Wet/Dry
- Surface Type: Slotted
- Style: Drainage
- Colour: Black
- Thickness: 7/8"
- Type: Anti-Fatigue

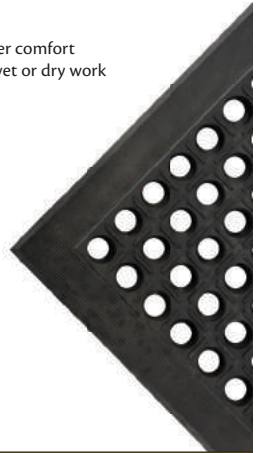

Model No.	Dim.		
	W'	x	L'
SFQ525	3	x	5

Available in other lengths, call for a quote

WORKRITE II NO. 468

1/2" THICK GENERAL PURPOSE ANTI-FATIGUE DRAINAGE MATS

- Made of grease-resistant natural rubber for use around water and non-caustic agents
- Hygienic open design accommodates small parts and debris
- Versatile, lightweight and economical
- Features molded-in beveled edges

1-YEAR WARRANTY

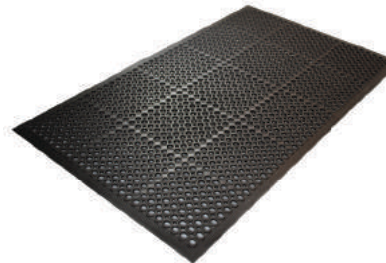

SDM621



Model No.	Dim.		
	W'	x	L'
SDM621	3	x	5
SDM618	3	x	10
SDM619	3	x	20

ELEVATE SPORT NO. 372 DRAINAGE MAT

- Ultimate sports and leisure matting for wet, barefoot traffic
- Lightly embossed surface that delivers both comfort and slip prevention underfoot
- Below the surface, channeled underbars provide fast, multi-directional drainage
- Constructed of UV resistant, anti-fungal and anti-microbial PVC
- Surface Type: Slotted
- Style: Drainage
- Environment: Wet
- Thickness: 3/8"
- Type: Anti-Fatigue

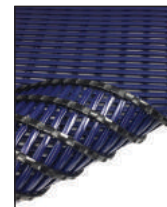

JH565



Model No.	Colour	Dim.		
		W'	x	L'
JH565	Blue	2	x	3
JH568	Blue	3	x	5
JH597	Charcoal	2	x	3
JH600	Charcoal	3	x	5

ELECTRICALLY CONDUCTIVE ANTI-FATIGUE NO. 786DP/786SM

- Ideal for use in areas at risk for damage from static electricity from workers before it can be passed on to sensitive equipment with microprocessors or to flammable liquids
- Surface prevents the accumulation of static electricity
- Nitricell® sponge base provides superior comfort and productivity
- This mat must be grounded; for maximum effectiveness, ground every 8' to 10'
- 9/16" thick
- Colour: Black

NB692



Protects workers from fatigue & electronic equipment from damage!

4-YEAR WARRANTY



Model No.	Dim.		Description	Wt. lbs.
	W'	L'		
SAL243	2	3	Smooth Surface	8.1
NB692	3	5	Diamond Plate Surface	23
SAR335	3	5	Smooth Surface	16.1
ACCESSORIES				
SAJ574	15' L Ground Wire (Sold Separately)			
SAL252	Heel Gronder No 793HG			

CLEAN ROOM MAT

- Adhesive surface removes dirt and dust from shoes and equipment wheels
- Ideal for reducing contamination in clean rooms and controlled environments
- Each layer can be used multiple times and removed once dirty
- Place on tile, concrete or low-profile carpeting
- Material: Polyethylene
- No. of Sheets: 30

SDS992



SDS993



Model No.	Dimensions L" x W"		Thickness	Colour
SDS992	36	18	40 mics	Blue
SDS993	36	18	40 mics	White
SDS994	45	18	40 mics	Blue
SDS995	45	18	40 mics	White
SDS996	45	24	40 mics	Blue
SDS997	45	24	40 mics	White
SDS998	36	24	40 mics	Blue
SDS999	36	24	40 mics	White
SDT001	45	36	40 mics	Blue
SDT002	45	36	40 mics	White

FOOT SANITIZING MATS

- Foot sanitizing mats are designed to decontaminate shoes and boots from spreading germs and bacteria
- Ideal for food processing facilities
- Rubber scrappers at the base of the mat dislodge contaminants from shoes or boots while the soles are soaking in solution
- Chemically resistant to common disinfectant solutions
- Capacity: 5.5 gallons
- Dimensions: 32" W x 39" L
- Colour: Black

SDL873

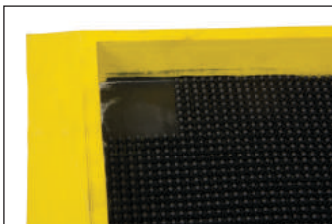
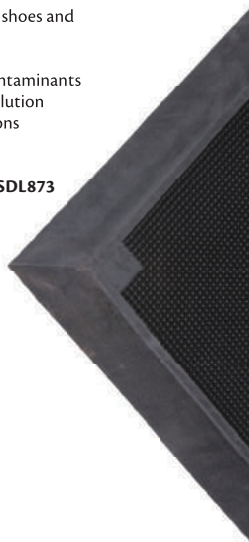

SDL874



Model No.	Border Colour
SDL873	Black
SDL874	Yellow

NON-CONDUCTIVE CORRUGATED SWITCHBOARD NO. 702

CAN INSULATE UP TO 30 000 V!

- High-performance non-conductive matting protects personnel in areas with dangerous high-voltage equipment
- Maximum rating: 30 000 V
- Recommended usage: up to 17 000 V
- The corrugated surface is abrasion resistant and easily cleaned
- 1/4" thick
- Conforms to ANSI/ASTM D-178-01 Type 2, Class II
- Passes MSHA IC-246 fire resistance test (mining safety)
- Colour: Black

SAL242

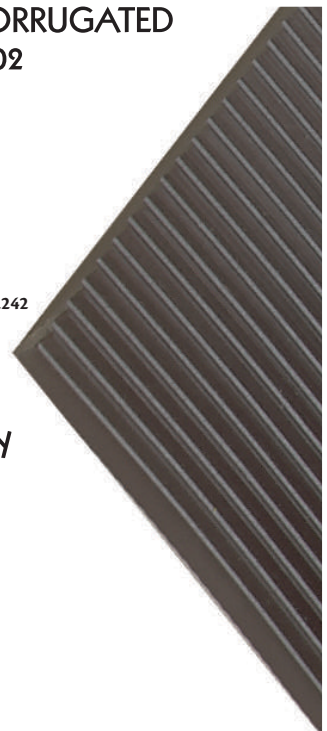

1-YEAR WARRANTY



WEARWELL

Model No.	Dim.	
	W'	L'
SAL242	2	75
NB657	3	75

FLAMMABLE STORAGE CABINETS

- Double-wall 18-gauge welded steel construction with 1 1/2" air space
- Dual 2" capped vents with flame arrestors
- Full-height piano hinges open a full 180° for easy access
- Recessed handle • 2" high leak proof door sill
- All shelves are adjustable on 2 1/2" centers
- Adjustable leveling feet
- Tough corrosive resistant finish
- Standard Met: FM/NFPA/OSHA
- Meets NFPA Code 30 and OSHA standard 1910.106 for storage for class I, II and III liquids



Model No.	Door Type	Capacity Gallons	No. of Shelves	No. of Doors	Exterior Dimensions		
					W" x D" x H"		
SDN642	Manual	12	1	1	23 x 18 x 35		
SDN643	Manual	16	1	1	23 x 18 x 44		
SDN644	Manual	22	1	2	35 x 22 x 35		
SDN645	Manual	24	3	2	43 x 12 x 44		
SDN646	Manual	30	1	2	43 x 18 x 44		
SDN647	Manual	45	2	2	43 x 18 x 65		
SDN648	Manual	60	2	2	34 x 34 x 65		

ACCESSORIES

Model No.	Type	For use with cabinet capacity	Dimensions (W" x D")
SEE922	Extra Shelves	12 & 16 Gal.	19 1/2 x 14
SEE923	Extra Shelves	22 Gal.	31 1/2 x 18
SEE924	Extra Shelves	24 Gal.	39 1/2 x 8
SAQ328	Extra Shelves	30 & 45 Gal.	39 3/8 x 14
SAS574	Extra Shelves	60 & 96 Gal.	30 3/8 x 30
SDN844	Poly Tray	22, 30 & 45 Gal. (2 trays per cabinet)	15 3/4 x 14

SDN647



PAINT/INK CABINETS

- Double-wall 18-gauge welded steel construction with 1 1/2" air space
- Dual 2" capped vents with flame arrestors
- Full-height piano hinges open a full 180° for easy access
- Recessed handle • 2" high leak proof door sill
- All shelves are adjustable on 2 1/2" centers
- Adjustable leveling feet
- Tough corrosive resistant finish
- Standard Met: FM/NFPA/OSHA



Model No.	Door Type	Capacity Gallons	No. of Shelves	No. of Doors	Exterior Dimensions		
					W" x D" x H"		
SDN649	Manual	20	2	1	23 x 18 x 44		
SDN650	Manual	45	3	2	43 x 18 x 44		
SDN651	Manual	60	5	2	43 x 18 x 65		
SDN652	Manual	96	5	2	34 x 34 x 65		

ACCESSORIES

Model No.	Type	For use with cabinet capacity	Dimensions (W" x D")
SEE922	Extra Shelves	12 & 16 Gal.	19 1/2 x 14
SEE923	Extra Shelves	22 Gal.	31 1/2 x 18
SEE924	Extra Shelves	24 Gal.	39 1/2 x 8
SAQ328	Extra Shelves	30 & 45 Gal.	39 3/8 x 14
SAS574	Extra Shelves	60 & 96 Gal.	30 3/8 x 30
SDN844	Poly Tray	22, 30 & 45 Gal. (2 trays per cabinet)	15 3/4 x 14

SDN651



CORROSIVE LIQUIDS CABINETS

- Double-wall 18-gauge welded steel construction with 1 1/2" air space
- Dual 2" capped vents with flame arrestors
- Full-height piano hinges open a full 180° for easy access
- Recessed handle • 2" high leak proof door sill
- All shelves are adjustable on 2 1/2" centers
- Adjustable leveling feet
- Tough corrosive resistant finish
- Includes two polyethylene trays
- Standard Met: FM/NFPA/OSHA



Model No.	Door Type	Capacity Gallons	No. of Shelves	No. of Doors	Exterior Dimensions		
					W" x D" x H"		
SDN653	Manual	22	1	2	35 x 22 x 35		
SDN654	Manual	30	1	2	43 x 18 x 44		
SDN655	Manual	45	2	2	43 x 18 x 65		

ACCESSORIES

Model No.	Type	For use with cabinet capacity	Dimensions (W" x D")
SEE922	Extra Shelves	12 & 16 Gal.	19 1/2 x 14
SEE923	Extra Shelves	22 Gal.	31 1/2 x 18
SEE924	Extra Shelves	24 Gal.	39 1/2 x 8
SAQ328	Extra Shelves	30 & 45 Gal.	39 3/8 x 14
SAS574	Extra Shelves	60 & 96 Gal.	30 3/8 x 30
SDN844	Poly Tray	22, 30 & 45 Gal. (2 trays per cabinet)	15 3/4 x 14

SDN655



SAFETY CABINETS

SURE-GRIP® EX FLAMMABLE STORAGE CABINETS

- Double wall welded 18-gauge steel construction with 1 1/2" of insulating air space
- Doors self-latch for easy and secure closure
- U-Loc™ handle comes with two keys or accepts optional padlock for greater security
- Two flame arrester vents and ground wire connection screw
- 2" deep leakproof sill
- Adjustable leveler legs and galvanised SpillSlope™ shelves
- Haz-Alert™ reflective warning labels offer visibility under dark conditions
- Durable yellow powder coat paint finish
- Meet NFPA and OSHA requirements
- FM approved

10 Year
Limited Warranty



Model No.	Mfg. No.	Door Type	Capacity Gallons	Adjustable Shelves	Ext. Dim. W" x D" x H"	Wt. lbs.
SAP509	893000	2 Doors, Manual	30	1	43 x 18 x 44	231
SAQ021	893020	2 Doors, Self-Closing	30	1	43 x 18 x 44	237
SAP510	894500	2 Doors, Manual	45	2	43 x 18 x 65	310
SAQ023	894520	2 Doors, Self-Closing	45	2	43 x 18 x 65	313
SAQ024	896000	2 Doors, Manual	60	2	34 x 34 x 65	387
SAQ025	896020	2 Doors, Self-Closing	60	2	34 x 34 x 65	392
SAQ026*	899000	2 Doors, Manual	90	2	43 x 34 x 65	480
SAQ027*	899020	2 Doors, Self-Closing	90	2	43 x 34 x 65	480

*Codes state that not more than 60 gallons may be Class I and Class II liquids.

SURE-GRIP® EX PAINT & INK STORAGE CABINETS

Offers the same safety and quality features and options that are available in Justrite's safety cabinets for flammables with additional shelves.

- Multiple shelves are ideal for 1-gallon paint cans (Class III liquids)
- Cabinets are available in 20, 40, 60 and 120-gallon capacities
- U-Loc™ handle comes with double key set or accepts optional padlock for greater security
- Haz-Alert™ reflective warning labels offer visibility under dark conditions
- Durable red powder coat paint finish easily identifies contents and is highly chemical resistant
- Meets NFPA and OSHA regulations
- FM approved

10 Year
Limited Warranty



Model No.	Mfg. No.	Door Type	Capacity Gallons	Adjustable Shelves	Ext. Dim W" x D" x H"	Wt. lbs.	
SAQ079	891511	1 Door, Manual, Compac	20	2	23 1/4 x 18 x 44	154	
SAQ081	893011	2 Doors, Manual	40	3	43 x 18 x 44	239	
SAQ084	894511	2 Doors, Manual	60	5	43 x 18 x 65	345	
SAQ087*	896011	2 Doors, Manual	96	5	34 x 34 x 65	424	
EXTRA SHELVES							
SAP839	29937	Extra Shelf for 40-Gallon Cabinets					
SAQ028	29944	Extra Shelf for 60-Gallon Cabinets					

*Codes state that not more than 60 gallons may be Class I and Class II liquids.

SURE-GRIP® EX SAFETY CABINETS

These cabinets offer U-Loc™ handles and come with a double key set or accept an optional padlock for greater security. They also have Haz-Alert™ reflective warning labels to offer visibility under dark conditions. Yellow powder-coat paint finish. Meet NFPA and OSHA regulations.

WALL MOUNT

- Avoids taking up extra floor space
- Mount easily with furnished brackets
- FM approved

COUNTERTOP & COMPAC

- Increased access to often-used liquids, without compromising safety
- Portable size keeps work areas flexible
- Each has one adjustable shelf
- A great size for the home handyman
- Compac cabinets are FM approved

SLIMLINE

- Three adjustable shelves provide flexible, safe storage
- Small footprint allows placement almost anywhere
- FM approved

STACKABLE "PIGGYBACK"

- Designed to mount on top of Justrite's standard 30 and 45-gallon safety cabinets
- Can be used singly or stacked to provide expanded or segregated storage of flammables
- Suitable for wall mounting or countertop use
- FM approved

Piggyback



Compac



Countertop



Slimline



10 Year
Limited Warranty

Model No.	Mfg. No.	Type	Door Type	Capacity Gallons	Adjustable Shelves	Ext. Dim. W" x D" x H"	Wt. lbs.
SAQ034	890400	Countertop	1 Door, Manual	4	1	17 x 17 x 22	62
SAQ036	891200	Compac	1 Door, Manual	12	1	23 1/4 x 18 x 35	129
SAQ038	891500	Compac	1 Door, Manual	15	1	23 1/4 x 18 x 44	154
SAQ040	893400	Wall Mount	2 Doors, Manual	20	5	43 x 12 x 44	221
SAQ030*	891300	Piggyback	2 Doors, Manual	12	-	43 x 18 x 18	129
SAQ031*	891700	Piggyback	2 Doors, Manual	17	1	43 x 18 x 24	157
SAQ032	892200	Slimline	1 Door, Manual	22	3	23 x 18 x 65	200

EXTRA SHELVES

Model No.	Mfg. No.	Description	Wt. lbs.
SAQ043	29936	For 12 and 15-Gallon Compac Cabinets	5

*Piggyback cabinets are not to be used with sliding door cabinets.

DRUM STORAGE SURE-GRIP® EX SAFETY CABINETS

Suitable for storage of larger quantities of flammable liquids and have all the same features as Justrite®'s standard safety cabinets.

- Two manual doors
- Safely store one or two 55-gallon US drums
- Half-depth shelf allows additional storage of Class III flammables
- Accommodates drums equipped with pumps or funnels
- Rollers at bottom of cabinet facilitate drum movement
- Ramp for drum cabinets (sold separately) aids in loading drums with a hand truck

SAQ046



10 Year
Limited Warranty

Model No.	Mfg. No.	Drum US Cap.	Ext. Dim.			Listings & Approvals	Wt. lbs.
			W"	x D"	x H"		
SAQ046	896260	1-55 Gallons	34	x 34	x 65	FM	425
SAQ048	899160	2-55 Gallons	59	x 34	x 65	-	781

FLAMMABLE STORAGE CABINETS

ULC APPROVED – 2" FIBRE INSULATED

- Double wall welded 18-gauge steel construction, filled with a fire-proof insulation
- Two manual-close doors
- Full length piano-hinged doors with three-point lock
- Two 2" flame arrestor vents and ground wire connection screw
- 2" deep leak-proof sill, adjustable galvanised shelves on 1/2" centres
- Zinc-plated leveler legs

SA088



herbertwilliams
FIRE EQUIPMENT LTD.

Model No.	Mfg. No.	Cap. Gal.	Adjustable Shelves	Ext. Dimensions			Wt. lbs.
				W"	x D"	x H"	
SA087	WB30	30	1	44	x 19	x 45	350
SA088	WB45	45	2	44	x 19	x 66	430

GAS CYLINDER CABINETS

- Heavy-duty construction
- 2" x 2" 10-gauge formed steel angle posts
- 9-gauge wire mesh doors and walls for venting
- 14-gauge checker plate shelves and roof

- English and French warning labels included
- Padlock hasp for added security
- Innovative door design allows for left or right opening installation
- Easy assemble, knock-down feature saves on shipping costs

Note: Constructed to meet or exceed strict CSA International B149.2-0 Propane Storage and Handling Code. Cylinders must be stored vertically at all times.

KLETON

COMPRESSED GAS (9" DIAMETER CYLINDERS)

Model No.	W"	Dimensions		Cylinder Capacity	Wt. lbs.
		x D"	x H"		
SAF837	44	x 30	x 74	10	210
SAF848*	88	x 30	x 74	20	420

*Consists of two units of the SAF837

LIQUID PROPANE (35-LB CYLINDERS)

Model No.	W"	Dimensions		Cylinder Capacity	Wt. lbs.
		x D"	x H"		
SEB837*	30	x 17	x 37	2	70
SEB838*	17	x 17	x 69	2	85
SAF836	44	x 30	x 37	6	135
SAF847	44	x 30	x 74	12	270

*All welded, fully assembled



SAF837



SEB837



SEB838



SAF847

SURE-GRIP® EX ACID/CORROSIVE STORAGE CABINETS

Built to the same standards as Justrite®'s flammable storage cabinets with the addition of poly tray liners and a specially formulated epoxy, powder coat paint.

- Poly liners on shelves and poly sump liner are removable for easy cleaning
- 30-gallon cabinet is also equipped with a poly cabinet top work tray
- All cabinets come with the stylish flush-mounted U-Loc™ handle that offers easy fingertip access and accepts optional padlock
- Haz-Alert™ reflective warning labels
- Undercounter model has a 3 1/2" H x 2 1/2" D kick plate to mount flush with other cabinetry
- Meets NFPA and OSHA regulations
- FM approved

Note: Not to be used with phenol, nitric and sulfuric acids.



10 Year
Limited Warranty

Model No.	Mfg. No.	Door Type	Capacity Gallons	Adjustable Shelves	Ext. Dim. W" x D" x H"	Wt. lbs.
SAQ056	892202	1 Door, Manual, Slimline	22	3	23 1/4 x 18 x 65	208
SAQ057	893002	2 Doors, Manual	30	1	43 x 18 x 44	239
SAQ060	894502	2 Doors, Manual	45	2	43 x 18 x 65	301
SAQ062	894522	2 doors, Self-Closing	45	2	43 x 18 x 65	200

ACCESSORIES

SAQ044	29939	Extra Shelf for 22-Gallon Undercounter Cabinets	10
SAQ063	29965	Poly Tray for 22-Gallon Undercounter Cabinets	6
SAP839	29937	Extra Shelf for 30 and 45-Gallon Cabinets	8
SAQ064	29962	Poly Tray for 30 and 45-Gallon Cabinets	22

SAQ055



SAQ056



SAQ057

SAFETY CONTAINERS & FIRE EXTINGUISHERS

TYPE I SAFETY CANS

- Fully compliant Type I safety cans with stainless steel flame arresters
- Chemical resistant, provides faster liquid flow, and offers exceptional durability and corrosion protection
- Self-venting, self-closing leak tight lid prevents ruptures from pressure build-up and controls vapours and spills
- Warning label includes large ID zone for user labelling
- Optional poly funnel offers targeted pouring
- FM approved, UL/ULC listed
- 10-year limited warranty



Red Model No.	Mfg. No.	Yellow Model No.	Mfg. No.	Capacity	Ext. Dim. Dia.,"	x	H"
WITH FUNNEL							
SEA240	7110110	SEA241	7110210	1 US Gal.	9 1/2	x	11
SEA204	7120110	SEA244	7120210	2 US Gal.	9 1/2	x	13 3/4
SEA208	7125110	SEA247	7125210	2.5 US Gal.	11 3/4	x	11 1/2
SEA213	7150110	SEA250	7150210	5 US Gal.	11 3/4	x	16 7/8
WITHOUT FUNNEL							
SAI516	10001	-	-	1 Pint	4 5/8	x	6 3/4
SAI517	10101	-	-	1 Quart	4 5/8	x	8 1/4
SEA199	7110100	SEA200	7110200	1 US Gal.	9 1/2	x	11
SEA203	7120100	SEA205	7120200	2 US Gal.	9 1/2	x	13 3/4
SEA207	7125100	SEA209	7125200	2.5 US Gal.	11 3/4	x	11 1/2
SEA212	7150100	SEA214	7150200	5 US Gal.	11 3/4	x	16 7/8

Other colours available, call us today!

LABORATORY SAFETY CANS IN STEEL & POLYETHYLENE

Convenient dispensing in two styles for use on shelves or in tilt stands.

- Self-closing faucets offer controlled dispensing of hazardous liquids
- Fill spouts have self-closing pressure relief caps with built-in vacuum breakers and double mesh flame arresters
- The lab faucet allows easier dispensing into containers with small openings
- FM approved 5 US gallon cans



Model No.	Mfg. No.	Description	Faucet
SEC080	7150140	Steel Shelf Can	Control Flow Lab, 3/4" Brass
SEC081	7150150	Steel Shelf Can	3/4" NPT Rigid Brass
SEC082	7150146	Steel Tilt Can w/Stand	Control Flow Lab, 3/4" Brass
SEC083	7150156	Steel Tilt Can w/Stand	3/4" NPT Rigid Brass
SEC084	14545	Polyethylene Shelf Can	Control Flow Lab, 3/4" Brass
SEC085	14535	Polyethylene Tilt Can W/Stand	Control Flow Lab, 3/4" Brass

STEEL DRY CHEMICAL ABC FIRE EXTINGUISHERS

- Steel cylinder complete with cylinder skirt
- Industrial-strength cylinder has high corrosion and impact-resistant polyester powder paint finish
- Waterproof stainless steel gauge
- Anodised aluminum valve
- Strong polyester powder-coated steel handles
- Completely rechargeable
- Full hand grip for ease of operation
- ULC listed

SC951 Wall Hooks



Model No.	Mfg. No.	Cap. lbs.	Rating	Range Feet	Discharge Time Sec.	PSI	H"	Dia."	Included Bracket	Wt. lbs.
SAQ814	WBDL-ABC110VB	2.5	1A:10BC	8-10	12-14	150	15 1/2	3 1/8	Vehicle	4 1/4
SA445	WBDL-ABC310LV	5	3A:10BC	8-10	13-14	195	16	4 1/4	Wall	10 1/2
SC946	WBDL-ABC310VVB	5	3A:10BC	8-10	13-14	195	16	4 1/4	Vehicle	10 1/2
SED109*	WBDL-ABC340LV	5	3A:40BC	8-10	13-14	195	16	4 1/4	Vehicle	10 1/2
SA443	WBDL-ABC10WH	10	6A:80BC	10-15	14-16	235	21 1/4	5 1/8	Wall	19 1/4
SA444	WBDL-ABC20WH	20	10A:120BC	10-15	20-22	235	24	7 1/8	Wall	35 1/4
SED110	WBDL-ABC30WH	30	10A:120BC	10-15	28	195	30 3/4	7 1/8	Wall	50 1/3

*Meets requirements for forklifts



TYPE II ACCUFLOW™ SAFETY CANS

- AccuFlow™ exclusive Safe-Squeeze® trigger mechanism allows for smooth flow and accurate pouring
- Auto-venting pressure relief cap
- Leak proof self-closing gasketed lid controls vapours and spills
- Long lasting stainless steel flame arrester dissipates heat and prevents flashback ignition
- Extra large ID zone reduces misuse and has warning in three languages
- FM approved, UL/ULC listed
- 10-year limited warranty



Red Model No.	Mfg. No.	Yellow Model No.	Mfg. No.	Capacity US Gal.	Ext. Dim. Dia.,"	x	H"
5/8" HOSE WIDTH							
SEA217	7210120	SEA218	7210220	1	9 1/2	x	10 1/2
SEA221	7220120	SEA222	7220220	2	9 1/2	x	13 1/4
SEA224	7225120	SEA226	7225220	2.5	11 3/4	x	12
SEA232	7250120	SEA234	7250220	5	11 3/4	x	17 1/2
1" HOSE WIDTH							
SEA225	7225130	SEA227	7225230	2.5	11 3/4	x	12
SEA233	7250130	SEA235	7250230	5	11 3/4	x	17 1/2

Other colour/capacity/hose width combinations available, call us today!

OILY WASTE CANS

- OSHA compliant oily waste cans are essential whenever solvent cloths and wiping rags are used
- Self-closing cover reduces oxygen source to prevent fire from starting
- Round construction and raised bottom encourage air circulation to disperse heat and prevent rust
- Rugged galvanised steel body in a variety of sizes accommodates any work area
- Carrying handle for portability
- 6 - 21 US gallon foot-operated units are FM approved and UL listed
- 2 US gallon hand-operated, countertop model is FM approved



Yellow Model No.	Mfg. No.	Red Model No.	Mfg. No.	Cap US Gal.	Ext. Dimensions Dia.,"	x	H"	Wt. lbs.
SR361	09200Y	SR356	09200	2	9 5/8	x	9 1/8	6
SR362	09101	SR357	09100	6	11 7/8	x	15 7/8	10
SR363	09301	SR358	09300	10	13 15/16	x	18 1/4	13
SR364	09501	SR359	09500	14	16 1/16	x	20 1/4	16
SR365	09701	SR360	09700	21	18 3/8	x	23 7/16	22

SPILL KITS ALLOW FOR IMMEDIATE CLEAN-UP OF SPILLS

Choice of oil, universal or hazmat kits. Oil kits can handle oil and fuel spills on land or on water. Universal kits handle more general purpose spills such as acids, caustics (bases), common fluids such as coolants, ethanol, pesticides and solvents. Hazmat kits handle chemical and more toxic fluids.

95-GALLON SPILL KITS

- 50 Sorbent Pads, 15" x 17"
- 5 Sorbent Socks, 3" x 48"
- 5 Sorbent Pillows, 8" x 18"
- 4 Sorbent Booms, 5" x 10"
- 1 Sorbent Roll, 15" x 150"
- 1 Drain Cover, 36" x 36"
- 1 Caution Tape, 3" x 300"
- 2 Pairs Nitrile Gloves, 2XL (11)
- 2 Pairs Safety Goggles, One Size
- 2 Microporous Coveralls, XL
- 10 Disposal Bags, 26" x 36"



Mobile Version



Description	Oil Only Model No.	Universal Model No.	Hazmat Model No.
Spill Kit	SEJ262	SEI167	SEJ263
Mobile Spill Kit	SEJ264	SEI494	SEJ265
Replacement Kit*	SEJ824	SEI873	SEJ826

*Replacement kit does not include original package container

55-GALLON SPILL KITS

- 50 Sorbent Pads, 15" x 17"
- 5 Sorbent Socks, 3" x 48"
- 3 Sorbent Socks, 3" x 120"
- 1 Drain Cover, 36" x 36"
- 1 Pair Nitrile Gloves, 2XL (11)
- 2 Microporous Coveralls, XL
- 1 Pair Safety Goggles, One Size
- 3 Disposal Bags, 26" x 36"



Description	Oil Only Model No.	Universal Model No.	Hazmat Model No.
Spill Kit	SEI196	SEI195	SEJ271
Replacement Kit*	SEI576	SEJ833	SEJ834

*Replacement kit does not include original package container

5-GALLON SPILL KITS

- 5 Sorbent Socks, 3" x 48"
- 1 Pair Nitrile Gloves, 2XL (11)
- 1 Pair Safety Goggles, One Size
- 2 Disposal Bags, 26" x 36"



Description	Oil Only Model No.	Universal Model No.	Hazmat Model No.
Spill Kit	SEJ975	SEI160	SEJ286
Replacement Kit*	SEJ976	SEJ858	SEJ859

*Replacement kit does not include original package container

63-GALLON SPILL KITS

- 100 Sorbent Pads, 15" x 17"
- 4 Sorbent Socks, 3" x 120"
- 4 Sorbent Pillows, 18" x 18"
- 1 Drain Cover, 36" x 36"
- 1 Optisorb®, 25-lb. Bag
- 2 Pairs Nitrile Gloves, 2XL (11)
- 2 Pairs Safety Goggles, One Size
- 3 Disposal Bags, 26" x 36"



Mobile Version



Description	Oil Only Model No.	Universal Model No.
Mobile Spill Kit	SEI198	SEI197
Replacement Kit*	SEI943	SEI944

*Replacement kit does not include original package container

30-GALLON SPILL KITS

- 75 Sorbent Pads, 15" x 17"
- 4 Sorbent Socks, 3" x 120"
- 1 Drain Cover, 36" x 36"
- 1 Caution Tape, 3" x 300"
- 2 Pairs Nitrile Gloves, 2XL (11)
- 2 Pairs Safety Goggles, One Size
- 2 Microporous Coveralls, XL
- 5 Disposal Bags, 26" x 36"



Description	Oil Only Model No.	Universal Model No.	Hazmat Model No.
Spill Kit	SEJ275	SEI165	SEJ276
Replacement Kit*	SEJ839	SEI614	SEJ840

*Replacement kit does not include original package container

20-GALLON SPILL KITS

- 50 Sorbent Pads, 15" x 17"
- 4 Sorbent Socks, 3" x 48"
- 2 Sorbent Pillows, 8" x 18"
- 1 Pair Nitrile Gloves, 2XL (11)
- 1 Pair Safety Goggles, One Size
- 1 Disposal Bag, 26" x 36"



Description	Oil Only Model No.	Universal Model No.	Hazmat Model No.
Spill Kit	SEJ291	SEI164	SEJ277
Replacement Kit*	SEJ841	SEJ842	SEJ843

*Replacement kit does not include original package container

10-GALLON VEHICLE SPILL KITS

- 20 Sorbent Pads, 15" x 17"
- 2 Sorbent Socks, 3" x 48"
- 2 Sorbent Pillows, 8" x 18"
- 1 Repair Putty, 4 oz.
- 1 Pair Nitrile Gloves, 2XL (11)
- 1 Pair Safety Goggles, One Size
- 2 Disposal Bags, 26" x 36"



Description	Oil Only Model No.	Universal Model No.	Hazmat Model No.
Spill Kit	SEI184	SEI183	SEJ284
Replacement Kit*	SEI888	SEI889	SEJ851

*Replacement kit does not include original package container

SPILL CONTROL

BONDED SORBENT PADS & ROLLS

- 100% bonded polypropylene fiber
- Ideal for applications that require increased tensile strength
- More durable than traditional meltblown sorbents
- Bonded pads offer low linting and permit an easy clean up
- All universal and hazmat pads and rolls are antistatic and made of up to 90% recycled materials
- All sorbent pads and rolls have absorption capacities of more than 25x their weight
- Rolls are perforated along the middle & cross direction every 18"
- Sold per package



OIL ONLY

Model No.	Weight	Dimensions L x W	Absorbency/Pkg. Gallons	Qty /Pkg.
-----------	--------	------------------	-------------------------	-----------

PADS - OIL ONLY

SEJ934	Heavy	15" x 17"	30	100
SEH968	Heavy	15" x 17"	10	25
SEH969	Medium	15" x 17"	25	100
SEI999	Light	15" x 17"	15	100
SEH970	Light	15" x 17"	30	200

ROLLS - OIL ONLY

SEH972	Heavy	150' x 30"	50	1
SEH971	Heavy	150' x 15"	25	1
SEJ001	Medium	150' x 30"	40	1
SEJ002	Medium	150' x 15"	20	1
SEH973	Light	300' x 30"	55	1

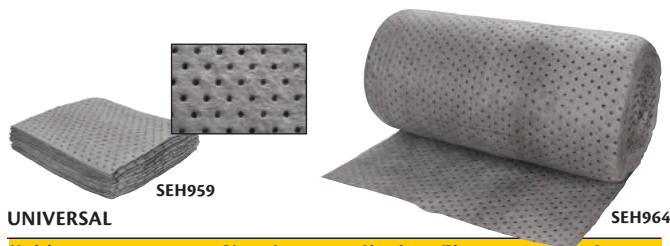

UNIVERSAL

Model No.	Weight	Dimensions L x W	Absorbency/Pkg. Gallons	Qty /Pkg.
-----------	--------	------------------	-------------------------	-----------

PADS - UNIVERSAL

SEJ935	Heavy	15" x 17"	30	100
SEH959	Heavy	15" x 17"	10	25
SEJ940	Medium	15" x 17"	25	100
SEH961	Light	15" x 17"	15	100
SEH962	Light	15" x 17"	30	200

ROLLS - UNIVERSAL

SEH966	Heavy	150' x 30"	50	1
SEH965	Heavy	150' x 15"	25	1
SEH964	Medium	150' x 30"	40	1
SEH963	Medium	150' x 15"	20	1

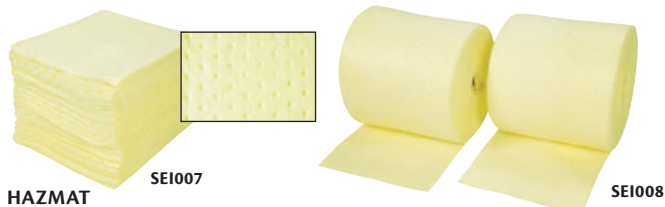

HAZMAT

Model No.	Weight	Dimensions L x W	Absorbency/Pkg. Gallons	Qty /Pkg.
-----------	--------	------------------	-------------------------	-----------

PADS - HAZMAT

SEI007	Heavy	15" x 17"	30	100
SEJ004	Medium	15" x 17"	25	100
SEJ005	Light	15" x 17"	15	100
SEJ006	Light	15" x 17"	30	200

ROLLS - HAZMAT

SEI009	Heavy	150' x 30"	50	1
SEI008	Heavy	150' x 15"	25	1
SEJ008	Medium	150' x 30"	40	1
SEJ009	Medium	150' x 15"	20	1

SORBENT PILLOWS

- Designed to recover and absorb large volumes of liquid
- Pillows can slide underneath dispensing units and machines to contain constant drips
- Oil only pillows are made from 100% polypropylene, and absorb more than 25x their weight
- Universal pillows are made from a polypropylene and cellulose blend, and absorb more than 18x their weight
- Sold per package



Model No.	Dimensions L' x W"	Absorbency/Pkg. Gallons	Qty /Pkg.
-----------	--------------------	-------------------------	-----------

PILLOWS - OIL ONLY

SEH956	18 x 8	25	10
SEH957	18 x 18	40	10

PILLOWS - UNIVERSAL

SEJ028	18 x 8	30	10
SEJ029	18 x 18	45	10

PILLOWS - HAZMAT

SEI006	18 x 8	30	10
SEI005	18 x 18	45	10

SORBENT SOCKS

- Durable polypropylene shell prevents tearing and offers maximum flexibility
- Perfect for surrounding leaking machinery and drains
- Oil only and hazmat socks are made from 100% polypropylene, and absorb more than 25x their weight
- Universal socks are made from a polypropylene and cellulose blend, and absorb more than 18x their weight
- Sold per package



Model No.	Dimensions L' x W"	Absorbency/Pkg. Gallons	Qty /Pkg.
-----------	--------------------	-------------------------	-----------

SOCKS - OIL ONLY

SEH955	120 x 3	45	10
--------	---------	----	----

SOCKS - UNIVERSAL

SEI048	120 x 3	40	10
--------	---------	----	----

SOCKS - HAZMAT

SEI004	120 x 3	45	10
--------	---------	----	----

RAG RUGS

- Made of 100% recycled cotton and polyester, with a binder on one side
- Excellent non-slip surface for work spaces
- Best suited for busy areas with leaks and drips
- Absorbs more than 12x its weight in oil, water, or chemicals
- Sold per package

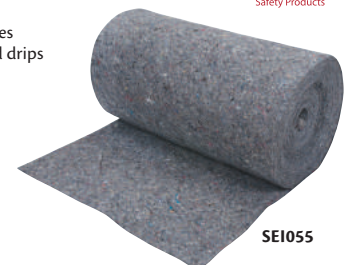

Model No.	Weight	Dimensions L' x W"	Absorbency/Pkg. Gallons	Qty /Pkg.
-----------	--------	--------------------	-------------------------	-----------

ROLLS - UNIVERSAL

SEI055	Heavy	150 x 36	50	1
--------	-------	----------	----	---

FINE FIBRE SORBENT PADS & ROLLS

- Premium fine fibre
- Bonded tri layered construction offers a smooth lint free finish that does not leave fibre residue behind
- Quickest absorption rate and increased durability
- Offers superior absorbency and strength
- Adheres well to floors to offer a secure footing
- All universal and hazmat pads and rolls are antistatic and made of up to 90% recycled materials
- All sorbent pads and rolls have absorption capacities of more than 25x their weight
- Sold per package



SEH975

SEI959

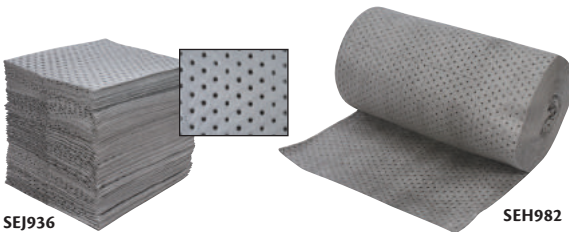

SEJ936

SEH982

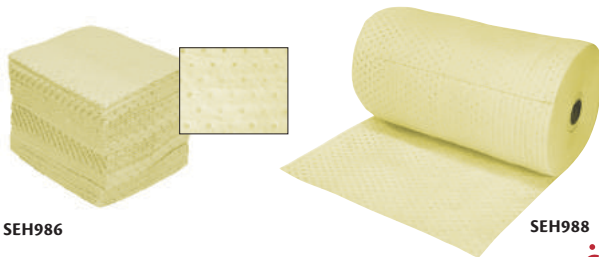

SEH986

SEH988

ZENITH
Safety Products

Model No.	Weight	Dimensions L x W	Absorbency/Pkg. Gallons	Qty /Pkg.
PADS – OIL ONLY				
SEH974	Heavy	15" x 17"	30	100
SEH975	Medium	15" x 17"	25	100
SEI977	Light	15" x 17"	30	200
ROLLS – OIL ONLY				
SEH976	Heavy	150' x 30"	50	1
SEH977	Heavy	150' x 15"	25	1
SEH978	Medium	150' x 30"	40	1
SEH979	Medium	150' x 15"	20	1
PADS – UNIVERSAL				
SEJ936	Heavy	15" x 17"	30	100
SEH981	Medium	15" x 17"	25	100
SEI978	Light	15" x 17"	30	200
ROLLS – UNIVERSAL				
SEH982	Heavy	150' x 30"	50	1
SEH983	Heavy	150' x 15"	25	1
SEH984	Medium	150' x 30"	40	1
SEH985	Medium	150' x 15"	20	1
PADS – HAZMAT				
SEH986	Heavy	15" x 17"	30	100
SEI979	Medium	15" x 17"	25	100
SEH987	Light	15" x 17"	30	200
ROLLS – HAZMAT				
SEH988	Heavy	150' x 30"	50	1
SEI980	Heavy	150' x 15"	25	1
SEI981	Medium	150' x 30"	40	1
SEI982	Medium	150' x 15"	20	1

DRIP DAM™ ROOF LEAK DIVERTERS

- Fast & efficient response to overhead leaks
- Convenient hose connector with cap
- Fits 5/8" and 1/2" standard garden hose, not included
- High chemical resistance
- Lightweight, reusable and easy to store
- Material: HDPE
- Attach with four bungee cords or rubber tie downs (not included)



Model No.	Dimensions'		
SEI133	3	x	3
SEI134	3	x	6
SEI136	6	x	10
SEI657	5	x	5
SEI658	6	x	6
SEI659	10	x	12
SEI660	12	x	12



RUBBER TIE DOWNS

- Other sizes available



Model No.	Size"	Max. Safe Stretch"
PE368	15	22 1/2



COLLAPSIBLE SHOVELS

- Aluminum
- Compact storage
- Easy-to-connect lock buttons permit rapid assembly
- Ideal for picking up sorbent material and to include in spill kits
- Durable aluminum handle
- Non-sparking, designed for emergency responses
- Assembled length: 29" L
- Collapsed size: 15"L x 10"W x 3"H
- Weight: 1.5 lbs.

Model No. SEI088
Mfg. No. 0401



NEOPRENE DRAIN COVERS

- Prevents contaminants from entering drain
- Resists oil, water and most aggressive chemicals, non-absorbing
- Cleans easily with soap and water between uses



Model No.	Dimensions				
	L"	x	W"	x	Thick"
SH104	36	x	36	x	1/16
SAP060	48	x	48	x	1/16

OPTISORB® GRANULAR ABSORBENT

- Made from diatomaceous earth, 100% natural and moisture free mineral
- All purpose absorbent designed for the quick clean up of water, oil and grease
- Very cost effective for every day spills
- Environmentally friendly
- 50% more absorbency per pound than clay alternatives
- 25-lb. bag

Model No. SEI076



SPILL CONTROL

POLY-OVERPACK® 20 & 30 SALVAGE DRUMS

- Versatile units that can contain solids and sludges with security
- Nestable for compact shipment
- 1/2-turn lid for easy opening and closing
- Built-in shoulder for easy handling
- UN rated salvage drums



POLY-OVERPACK® 20 SALVAGE DRUM

- Accepts bottles, cans, and 5-gallon pails
- 20 US gallon sump capacity
- **Exterior dimensions:** 23" top dia. x 18" bottom dia. x 19" H
- **Interior dimensions:** 21 1/2" top dia. x 17" bottom dia. x 17 1/2" H

POLY-OVERPACK® 30 SALVAGE DRUM

- Unit can contain up to 16 US gallon drums
- 30 US gallon sump capacity
- **Exterior dimensions:** 23" top dia. x 18" bottom dia. x 30" H
- **Interior dimensions:** 21 1/2" top dia. x 17" bottom dia. x 28 1/2" H

Model No.	Mfg. No.	Description	Wt. lbs.
SAG189	1220-YE	Poly-Overpack® 20	10
SAH551	1230-YE	Poly-Overpack® 30	13

POLY-OVERPACK® SALVAGE DRUM

- Takes industry standards to a whole new level
- Engineered with safety in mind
- Stacks, locks and transports more securely and efficiently than any other drum in the market
- Specifically designed to lock once stacked as a preventative measure for both employees and products
- Nesting lids create a safer and stronger nested stack for storage
- With a double start thread, unit only requires half a turn to tightly secure leaking drums
- Regulations: UN 1H2/X295/S, DOT 49 CFR 173.3(c), EPA, SPCC and NPDES
- **Exterior Dimensions:** 31.5" top dia. X 25.88" bottom dia. X 40" H
- **Interior Dimensions:** 27.5" top dia. X 24.5" bottom dia. X 36.5" H
- Sump Capacity: 95 US gallons
- Load Bearing Capacity: 650 lbs.
- Weight: 46.5 lbs.

Model No. SDM248
Mfg. No. 1095-YE



SPILL SCOOTER™

- 100% polyethylene construction
- Contains incidental spills and drips
- Spout included for easy draining
- Holds 55 US gallon drums
- Optional metal T-handle available separately, 36 5/8" long
- Dimensions: 35" Dia. x 9" H
- 500-lbs. load bearing capacity
- 11 US gallon capacity



Model No.	Mfg. No.	Description	Wt. lbs.
SB767	5205-YE	Spill Scooter™	26
SC554	5206-BK	T-Handle	3

POLY-OVERPACK® 65 SALVAGE DRUM

- Appropriate for 30 US gallon drums
- Nests for easy storage
- Gasket in the lid for secure containment
- Can be used as a spill kit container
- Light enough for one person to handle and large enough to pack sufficient absorbent for incidental spills
- Meets Group 1 packaging standards, salvage drum regulation
- Meets performance-oriented packaging requirements of US DOT and UN regulations
- Maximum handling capacity: 440 lbs.
- **Exterior dimensions:** 27 3/4" top dia. x 23" bottom dia. x 37 1/2" H
- **Interior dimensions:** 26 3/4" top dia. x 22" bottom dia. x 34 1/4" H



Model No.	Mfg. No.	Description	Wt. lbs.
SE471	1065-YE	Poly-Overpack® 65	47

WHEELED OVERPACK® SALVAGE DRUMS

- First mobile 1-piece Overpack® that can handle 55 US gallon drums
- Salvage drum and dolly all in one, eliminates the need for a separate dolly
- UN rated salvage drums, ideal for spill kits
- Built-in handles and 6" wheels allow for easy maneuverability
- Easy steering through doorways and around obstacles

SAL223



WHEELED OVERPACK® 50

- 50 US gallon sump capacity
- **Exterior dimensions:** 24" top Dia. x 18 1/2" bottom Dia. x 45 1/2" H
- **Interior dimensions:** 20" top Dia. x 17 3/4" bottom Dia. x 36" H

WHEELED OVERPACK® 95

- 95 US gallon sump capacity
- **Exterior dimensions:** 31 1/2" top Dia. x 25 3/4" bottom Dia. x 47 1/2" H
- **Interior dimensions:** 27" top Dia. x 25" bottom Dia. x 38 1/2" H

Model No.	Mfg. No.	Description	Sump Cap. US Gallons	Wt. lbs.
WHEELED OVERPACK® 50 SALVAGE DRUM				
SAL223	1259-YE	Polyolefin Wheels	50	38
WHEELED OVERPACK® 95 SALVAGE DRUM				
SAH549	1299-YE	Polyolefin Wheels	95	56

LEAK CONTAINMENT DRUM DOLLIES

- Polyethylene dolly will not dent, corrode, or rust
- Handles 45-gallon drums
- Solid bottom construction with a 2" lip contains spills up to 5 L
- Overall diameter: 24 1/4"
- Capacity: 1000 lbs.
- Grey



DC465

Model No.	Caster Type	Caster"	O.A. Height"
DC465	Polyurethane	3	6 1/4
DC466	Polyolefin	3	6 1/2
DC467	Polyolefin	4	7 1/4

NESTABLE 2-DRUM POLY-SPILLPALLET™

- 100% polyethylene provides excellent chemical resistance
- Removable grates for easy cleaning
- Forkliftable on two sides
- Holds two 55 US gallon drums
- Load bearing capacity of 2000 lbs.
- Sump capacity of 66 US gallons
- Available with drain hole and plug
- Meets EPA 40 CFR 264.175
- Overall dimensions: 51" L x 26" W x 21" H

SEI786



Model No.	Mfg. No.	Description	Wt. lbs.
SEI786	5222-YE	2-Drum Poly-Spillpallet™	45
SEI787	5222-YE-D	2-Drum Poly-Spillpallet™ w/Drain	45

LOW-PROFILE IN-LINE POLY-SPILLPALLET™ 3000

- 100% polyethylene
- Holds four 55 US gallon drums
- Low 12" profile
- Non-skid, removable grates
- Load bearing capacity of 3000 lbs.
- Sump capacity of 66 US gallons
- Poly-Ramp™ allows for easy loading of pallet

Drums Not Included



Model No.	Mfg. No.	Description	Dimensions			Wt. lbs.
			L"	W"	H"	
SB762	5102-YE	Poly-SpillPallet™	98	x 25 1/4	x 12	78
SB763	5102-YE-D	Poly-SpillPallet™ w/Drain	98	x 25 1/4	x 12	78
SAQ186	5039-BK	Poly-Ramp™	68	x 30 3/4	x 12 1/2	65

POLY-SLIM-LINE™ 6000

- 100% polyethylene with removable grates
- Features a low 12" profile
- Load bearing capacity of 6000 lbs.
- Sump capacity of 66 US gallons

MULTI-PURPOSE RACKER/STACKER™

- Holds up to two 55 US gallon drums
- Unit can be placed on the floor (no sump) or on the Poly-Slim Line™ 6000
- Load bearing capacity of 2400 lbs.
- Use with the Poly-Shelf™ for easy dispensing into 5 or 6-gallon pails
- Forkliftable

SE410 Pallet not included



SR442

Model No.	Mfg. No.	Description	Dimensions			Wt. lbs.
			L"	W"	H"	
SE408	5400-YE	Poly-Slim-Line™	54	x 54	x 12	84
SE409	5400-YE-D	Poly-Slim-Line™ w/Drain	54	x 54	x 12	84
SE410	6004-YE	Multi-Purpose Racker/Stacker™	48 1/2	x 41	x 20	60
SB773	6003-YE	Poly-Shelf™	17	x 22	x 17 1/2	8
SAQ186	5039-BK	Poly-Ramp™	68	x 30 3/4	x 12 1/2	65
SR442*	6005-BK	Universal™ Well Liner	14 1/2	x 17 1/2	x 2 1/2	1.5

*Can also be used with Poly-Dolly®

POLY-DOLLY®

THE MULTI-FUNCTIONAL, TWO-WHEEL DISPENSING STATION!

- Transports 55 US gallon drums with ease
- Tilts to become an efficient self-dispensing station
- Acts as its own secondary containment unit
- Integrally molded handles for extra strength
- Double looped strap for easy loading
- Accessible for forklift from the rear
- Raised ribbed dispensing well
- Drain plug for removal of contents from sump
- Available as an all terrain dolly
- Dimensions: 69" L x 32 1/2" W x 26 1/2" H
- 70 US gallon sump capacity
- 600-lbs. load bearing capacity

Drum Not Included SB769



Model No.	Mfg. No.	Description	Wt. lbs.
SB769	5300-YE	Poly-Dolly®	83
SB770*	5300-YE-A	Poly-Dolly® ATD	91

*All terrain dolly with heavy-duty semi-pneumatic rubber wheels



THE POLY-RACK™ SYSTEM

THE MOST EFFICIENT DISPENSING/STORAGE SYSTEM!

POLY-RACKER™

- One-piece polyethylene rack that holds two 55 US gallon drums
- 100 plus gallon containment sump
- Deep dispensing well easily holds 5-gallon pails
- Both sides of the unit have a drain plug
- Entire unit can be transported by forklift
- Rated to hold up to 3000 lbs.

POLY-STACKER™

- Holds two 55 US gallon drums
- Can be quickly stacked with a forklift
- Any spills from the second and third level falls into the dispensing well for containment and easy cleanup

POLY-SHELF™

- It easily attaches to Poly-Stacker™
- Allows simultaneous dispensing from all drums
- A hole in the bottom of the Poly-Shelf™ drains into the dispensing well in the Poly-Racker™

Model No.	Mfg. No.	Description	Max Capacity lbs.	Dimensions			Wt. lbs.
				L"	W"	H"	
SB771	6000-YE	Poly-Racker™	3000	49	x 53	x 23	105
SB772	6002-YE	Poly-Stacker™	2400	49	x 41	x 13	50
SR466	6006-YE	Single Poly-Racker™	1600	31	x 53	x 32	95
SR467	6007-YE	Single Poly-Stacker™	800	31	x 40 1/2	x 20	45
SB773*	6003-YE	Poly-Shelf™	60	17	x 22	x 17 1/2	8

*Use only with Poly-Stacker™ or single Poly-Stacker™



Drums Not Included



SPILL CONTROL

ECOPOLYBLEND™ SPILL CONTROL PALLETS

- Eco-friendly pallets are made of up to 100% recycled polyethylene, dirt hiding black colour is 100% recycled and high visibility yellow is 35% recycled content
- Fully compliant and quality engineered with a robust design, they withstand the toughest environments and are nearly impervious to chemical attack
- Featuring seamless construction, oversized sumps and sturdy removable self-locating grates, these pallets provide optimum, solid protection from leaks and spills
- 2-drum and 4-drum square pallets include wide forklift pockets for easy relocation
- Optional ramp for 4-drum square pallets offers convenience when loading and unloading heavy drums, and square or space saving linear styles in multiple sizes offer storage versatility
- Pallets meet or exceed EPA, SPCC, NFPA 1 and the International Fire Code

Drums not included



SBA855 shown with Ramp SBA859

SBA844



Yellow Model No.	Mfg. No.	Black Model No.	Mfg. No.	Description	Exterior Dimensions W" x D" x H"	Sump Cap. US Gallons	Load Bearing Cap.	Wt. lbs.
WITHOUT DRAIN								
SBA997	28622	SBA844	28623	2-Drum, In-Line	49 x 25 x 18	66	2500	44
SBA853	28626	SBA846	28627	3-Drum, In-Line	73 x 25 x 11 5/8	75	3750	58
SBA857	28630	SBA850	28631	4-Drum, In-Line	97 x 25 x 9	75	5000	77
SBA855	28634	SBA848	28635	4-Drum, Square	49 x 49 x 10 1/4	73	5000	70
WITH DRAIN								
SBA852	28624	SBA845	28625	2-Drum, In-Line	49 x 25 x 18	66	2500	44
SBA854	28628	SBA847	28629	3-Drum, In-Line	73 x 25 x 11 5/8	75	3750	58
SBA858	28632	SBA851	28633	4-Drum, In-Line	97 x 25 x 9	75	5000	77
SBA856	28636	SBA849	28637	4-Drum, Square	49 x 49 x 10 1/4	73	5000	70
ACCESSORIES								
SBA859	28620	-	-	Ramp for 4-Drum Square	49 x 33 x 10 1/2	-	1000	40
SBA860	28259	-	-	2-Drum Replacement Grate	24 x 48 x 2 1/2	-	-	16

ECOPOLYBLEND™ LOW PROFILE ACCUMULATION CENTRES

- High value secondary containment centres are eco-friendly, made of up to 100% recycled durable polyethylene, dirt hiding black colour is 100% recycled and high visibility yellow is 35% recycled content
- These handy platforms offer leak protection from drums, pails, batteries, or any other container of hazardous or non-hazardous liquids
- Sturdy, removable grates make sump cleaning easy while low profile offers convenience when loading/unloading
- Versatile modular design allows you to customize your workspace around existing structures, linear style or over entire floor
- Optional joining clips and Sump-to-Sump™ drain kit provide a continuous sump for on-site compliance when needed
- Accessory ramp can be located anywhere on any 2-drum or larger centre

Drums not included



Yellow Model No.	Mfg. No.	Black Model No.	Mfg. No.	Description	Exterior Dimensions W" x D" x H"	Sump Cap. US Gallons	Load Bearing Cap.	Wt. lbs.
SBA866	28652	SBA861	28653	1-Drum Unit	25 x 25 x 5 1/2	12	1250	17
SBA867	28654	SBA862	28655	2-Drum Unit	49 x 25 x 5 1/2	24	2500	32
SBA868	28656	SBA863	28657	4-Drum Unit	49 x 49 x 5 1/2	49	5000	61
SBA869	28658	SBA864	28659	6-Drum Unit	73 x 49 x 5 1/2	73	7500	91
SBA870	28660	SBA865	28661	8-Drum Unit	97 x 49 x 5 1/2	98	10000	122
SBA871	28650	-	-	Ramp	48 x 33 x 6 1/4	-	1000	41

HEAD & FACE PROTECTION

NORTH ZONE™ HARD HATS

- Slots for cap-mounted earmuffs, face shields and other PPE accessories
- 3-level height adjustment (Low, Medium, High) for greater stability, balance and retention
- Removable, replaceable rear comfort cradle for improved fit and comfort
- Easy-grip ratchet for smooth and precise headband adjustment, even when wearing gloves
- Ergonomic headband for easy adjustment to 3 different sizes (S, M/L and XL)
- Moisture-wicking, breathable sweatband; easily removable, washable and replaceable
- Short brim and low-profile design for increased field of vision and user mobility
- Approved to be worn in the reverse position
- Certification(s): ANSI Type I/CSA Type 1



SFM532



Model No.	Mfg. No.	Colour
PINLOCK SUSPENSION		
SFM500	N10010000	White
SFM501	N10020000	Yellow
SFM502	N10030000	Orange
SFM503	N10040000	Green
SFM504	N10050000	Hi-Viz Red
SFM505	N10070000	Sky Blue
SFM506	N10080000	Navy Blue
SFM507	N10090000	Grey
SFM508	N10100000	Tan
SFM509	N10110000	Black
SFM510	N10120000	Brown
SFM511	N10130000	Gold
SFM512	N10150000	Red
SFM513	N10170000	Royal Blue
SFM514	N10200000	Hot Pink
SFM515	N10440000	Hi-Viz Yellow
SFM516	N10460000	Hi-Viz Orange

Model No.	Mfg. No.	Colour
RATCHET SUSPENSION		
SFM517	N10R010000	White
SFM518	N10R020000	Yellow
SFM519	N10R030000	Orange
SFM520	N10R040000	Green
SFM521	N10R050000	Hi-Viz Red
SFM522	N10R070000	Sky Blue
SFM523	N10R080000	Navy Blue
SFM524	N10R090000	Grey
SFM525	N10R100000	Tan
SFM526	N10R110000	Black
SFM527	N10R120000	Brown
SFM528	N10R130000	Gold
SFM529	N10R150000	Red
SFM530	N10R170000	Royal Blue
SFM531	N10R200000	Hot Pink
SFM532	N10R440000	Hi-Viz Yellow
SFM533	N10R460000	Hi-Viz Orange

V-GARD® PROTECTIVE CAPS

OFFER COMFORTABLE, LIGHTWEIGHT PROTECTION

- V-Gard® protective caps from MSA consist of a polyethylene shell and suspension system working together as a protection system.
- V-Gard® headwear features slotted sides and advanced styling in standard (6 1/2 - 8) size.
- Available with Fas-Trac® or 1-Touch™ suspension.
- Caps meet or exceed the applicable requirements for a type I helmet (top impact) as outlined in ANSI Z89.1 and CSA Z94.1 class E.



Model No.	Mfg. No.	Colour
FAS-TRAC® SUSPENSION		
SAF970	475358	White
SAF971	475359	Blue
SAF972	475360	Yellow
SAF973	475361	Orange
SAF974	475363	Red
SAF975	475362	Green
SAF976	475364	Grey
SAF977	488146	Hi-Viz Orange
SAF978	815565	Hi-Viz Lime Green
SDL113	10061512	Hi-Viz Yellow Green
SAF981	492559	Black
1-TOUCH™ SUSPENSION		
SAM578	10057441	White
SAM579	10057442	Blue
SAM580	10057443	Yellow
SAM581	10061514	Hi-Viz Lime Green

MATTERHORN CSA TYPE 2

- Foam liner for extra protection from lateral impacts
- Rain trough
- Slotted for attachments
- Ratchet or Quick Fit suspension
- Quick Fit suspension is ultra-lightweight with locking action, simply squeeze buckle and loosen
- Certified to standard CSA Z94.1 type 2, Class E



Model No.	Mfg. No.	Suspension	Colour	Wt. oz.
SH342	A89010000	Quick Fit	White	14.7
SH343	A89020000	Quick Fit	Yellow	14.7
SH344	A89030000	Quick Fit	Orange	14.7
SH345	A89080000	Quick Fit	Dark Blue	14.7
SAI080	A89070000	Quick Fit	Sky Blue	14.7
SH346	A89040000	Quick Fit	Green	14.7
SH347	A89R010000	Ratchet	White	15.6
SH348	A89R020000	Ratchet	Yellow	15.6
SH349	A89R030000	Ratchet	Orange	15.6
SH350	A89R080000	Ratchet	Dark Blue	15.6
SAI081	A89R070000	Ratchet	Sky Blue	15.6
SH351	A89R040000	Ratchet	Green	15.6
ACCESSORIES				
SA0538	A89S2	Quick Fit 4-Point Suspension		
SAN022	A89RS2	4-Point Ratchet Suspension		

BIONIC™ FACESHIELDS

- Lightweight and balanced, ergonomic design for extended use
- Extended chin and top-of-head protection
- Enhanced protection from airborne debris
- Excellent optics and increased visibility
- Easy-to-set ratcheting headgear locking mechanism assures comfortable, secure fit
- Highly adjustable headgear tilts faceshield nearer or farther from face depending on preference and application
- Easily replaceable faceshield with dual position choices
- Comfortable cell foam on back of headgear
- Breathable, removable, washable headband
- Comfortably worn with most goggles and respirators
- **Compliant with CSA Z94.3 standards**



Model No.	Mfg. No.	Description
FACESHIELDS		
SAK421	S8500	Clear Uncoated Faceshield
SAK422	S8510	Clear Anti-Fog Hardcoat Faceshield
REPLACEMENT FACESHIELDS		
SAK423	S8550	Clear Uncoated
SAK424	S8555	Clear Anti-Fog Hardcoat

EYE PROTECTION

Z100

- Traditional design with integral sideshields
- Scratch-resistant polycarbonate lens with UV protection
- Adjustable temples provide a superior comfort and fit
- Molded-in nose bridge
- Distortion-free
- Black frame
- Compliant with CSA standard Z94.3

Model No.	Lens Tint
SEH642	Clear



Z200

- Superior protection at an economical price
- Ideal visitor spectacle
- Molded-in nose bridge
- Polycarbonate lens with UV protection
- Distortion-free
- Compliant with CSA standard Z94.3

Model No.	Lens Tint
SEF024	Clear



Z500

- Frameless design with extended wraparound coverage
- Scratch-resistant polycarbonate lens with UV protection
- Non-slip rubber head grips
- Distortion-free
- Standards met: CSA Z94.3/ANSI Z87+

Model No.	Lens Tint
SAP877	Clear
SAS362	Grey/Smoke
SAS363	Amber
SAS364	Blue
SEB183	Clear Anti-fog
SEA551	I/O Blue Mirror
SEE955	Orange



Z300

- Impact-proof polycarbonate lens with UV protection
- Adjustable elastic headband
- Indirect ventilation on SEF219 and SAN430 protects against dust, fumes and chemical splash
- Anti-fog lens on SAN430 is ideal for high humidity applications
- Distortion-free
- Compliant with CSA standard Z94.3

Model No.	Description
SEF218	Direct Vent
SEF219	Indirect Vent
SAN430	Indirect Vent Anti-Fog



Z600

- Frameless design with extended wraparound coverage
- Scratch resistant polycarbonate lens with UV protection
- Flexible temple design for added durability
- Near total seal of the eye provides superior protection
- Distortion-free
- Compliant with CSA standard Z94.3

Model No.	Lens Tint
SAW920	Clear
SFU766	Clear Antifog
SFU767	Grey/Smoke



Z700

- Frameless design with extended wraparound coverage
- Scratch-resistant polycarbonate lens with UV protection
- Ultra-soft non-slip nosepiece
- Flexible temple provides added durability
- Distortion-free
- Compliant with CSA standard Z94.3

Model No.	Lens Tint
SAX442	Clear



Z900

- Modern design with extended wraparound coverage
- Scratch-resistant polycarbonate lens with UV protection
- Non-slip rubber head grips
- Ultra-soft non-slip nosepiece
- Distortion-free
- Beige frame
- Compliant with CSA standard Z94.3

Model No.	Lens Tint
SAX444	Clear



Z1300

- Modern design with extended wraparound coverage
- Scratch-resistant polycarbonate lens with UV protection
- Non-slip rubber temples provide superior comfort and fit
- Ultra soft non-slip nosepiece
- Distortion-free
- Black frame
- Compliant with CSA standard Z94.3

Model No.	Lens Tint
SEC953	Clear



Z1400

- Modern design with extended wraparound coverage
- Scratch-resistant polycarbonate lens with UV protection
- Ultra soft non-slip nosepiece
- Distortion-free
- Black frame
- Compliant with CSA standard Z94.3

Model No.	Lens Tint
SEC954	Clear



Z1500

- Modern design with extended wraparound coverage
- Scratch-resistant polycarbonate lens with UV protection
- Ultra soft non-slip nosepiece
- Distortion-free
- White frame
- Compliant with CSA standard Z94.3

Model No.	Lens Tint
SEC955	Clear
SEI524	Grey/Smoke
SEI525	Amber
SEI526	Blue
SEI527	Mirror
SEI528	Antifog



Z1600

- Modern design with extended wraparound coverage
- Scratch-resistant polycarbonate lens with UV protection
- Ultra soft non-slip nosepiece
- Extendable and ratchet temple provides superior comfort and fit
- Distortion-free
- Black frame
- Compliant with CSA standard Z94.3



Model No.	Lens Tint
SEE817	Clear

Z1800

- Readers Lens
- Sporty design with extended wraparound coverage
- Scratch resistant polycarbonate lens with UV protection
- Ultra-soft non slip nosepiece
- Adjustable temples provide a superior comfort and fit
- Black frame
- Distortion-free
- Compliant with CSA standard Z94.3.



Model No.	Lens Tint	Diopter
SEH013	Clear	1.0
SEH014	Clear	1.5
SEH015	Clear	2.0
SEH016	Clear	2.5

Z1900

- Modern design with extended wraparound coverage
- Scratch-resistant polycarbonate lens with UV protection
- Ultra soft non-slip nosepiece
- Distortion-free
- Meets or exceeds CSA Z94.3 standard



Model No.	Lens Tint
SEH632	Clear
SEK286	Grey/Smoke
SEK287	Amber
SEK288	Blue
SEK289	I/O Full Mirror
SEK290	Clear Anti-Fog



Z2400

- Frameless design with extended wraparound coverage
- Flexible temple provides added durability
- Scratch resistant polycarbonate lens with UV protection
- Distortion-free
- Certification(s): Compliant to CSA Z94.3 standard and ANSI Z87+



Model No.	Lens Tint	Lens Coating
SET315	Clear	Anti-Scratch
SET316	Grey/Smoke	Anti-Scratch
SET317	Amber	Anti-Scratch
SET318	Blue	Anti-Scratch
SET319	I/O Blue Mirror	Anti-Scratch
SET320	Clear	Anti-Fog

Z2200

- Modern design with extended wraparound coverage
- Flexible temples provide superior comfort and fit
- Scratch-resistant polycarbonate lens with UV protection
- Distortion-free
- Clear frame
- Compliant with CSA standard Z94.3



Model No.	Lens Tint
SEK293	Clear

Z2500

- Sporty design with extended wraparound coverage
- Scratch resistant polycarbonate lens with UV protection
- Flexible rubber arms make for a comfortable fit
- Distortion-free
- Standard(s) Met: ANSI Z87+ and CSA Z94.3

SDN701



Model No.	Lens Tint	Lens Coating
SDN701	Clear	Anti-Scratch
SDN702	Grey/Smoke	Anti-Scratch
SDN703	Amber	Anti-Scratch
SDN704	Blue	Anti-Scratch
SDN705	Indoor/Outdoor Mirror	Anti-Scratch
SDN706	Clear	Anti-Fog

WITH REMOVABLE FOAM GASKET

SDN707	Clear	Anti-Scratch
SDN708	Grey/Smoke	Anti-Scratch
SDN709	Indoor/Outdoor Mirror	Anti-Scratch
SDN710	Clear	Anti-Fog

Z1100

- Indirect ventilation
- Can be used over most prescription eyewear
- Compliant with CSA standard Z94.3

Model No. SEK294



GOGGLES W/SAFETY SHIELD

- Indirect ventilation and a polycarbonate shield for full face protection
- Face shield detaches from the goggles
- Curved face shield conforms to the shape of the users face for added protection
- Can be used over most prescription eyewear
- Compliant with CSA standard Z94.3

Model No. SEL095



RESPIRATORS

6500 SERIES HALF FACEPIECE RESPIRATORS

- Provides comfort and stability with a soft but firm silicone face seal
- Resilient material extends product life
- Maintains its shape in high heat environments
- Overmolded, low-profile design simplifies cleaning and maintenance with fewer parts and crevices, and provides a wide field of view
- Valve cover design directs exhaled breath and moisture downwards, and facilitates a positive pressure seal check
- 3M™ Cool Flow™ Exhalation Valve enhances comfort by reducing heat and moisture, and allows for easier breathing
- Adjustable head harness assembly provides optimum fit and comfort with a three-size adjustable head cradle
- Long-lasting polyester spandex straps
- Optional quick-latch drop-down mechanism allows for easy on and off as workers move in and out of contaminated areas – no need to remove your hard hat or faceshield
- NIOSH approved



Model No.	Mfg. No.	Size
SEJ779	6501	Small
SEJ780	6502	Medium
SEJ781	6503	Large

W/QUICK-LATCH DROP-DOWN FEATURE

SEJ782	6501QL	Small
SEJ783	6502QL	Medium
SEJ784	6503QL	Large



Model No.	Mfg. No.	Description	Approved For	Qty /Pkg.
SDS613	6001i	Organic Vapours w/Service Life Indicator	Organic Vapours	2
SE892	6001	Organic Vapours	Organic Vapours	2
SE893	6002	Acid Gas	Chlorine/Hydrogen Chloride/Sulfur Dioxide/Chlorine Dioxide/Hydrogen Sulfide	2
SE894	6003	Organic Vapours/ Acid Gas	Organic Vapours/Chlorine/Hydrogen Chloride/ Sulfur Dioxide/Hydrogen Fluoride/Hydrogen Sulfide	2
SE896	6005	Formaldehyde	Formaldehyde and certain organic vapours	2
SE897	6006	Multi-Gas/ Vapour	Organic Vapours/Chlorine/Chlorine Dioxide/ Hydrogen Chloride/ Sulfur Dioxide/Hydrogen Fluoride/Hydrogen Sulfide/Ammonia/ Methylamine/Formaldehyde	2
SDS614	60921i	Organic Vapours/P100 w/Service Life Indicator	Organic Vapours/Permanently pre-attached P100 pre filter*	2
SE899	60921	Organic Vapour P 100	Organic Vapours/Permanently pre-attached P100 pre filter*	2
SE901	60923	Organic Vapours/Acid Gas/P100	Organic Vapours/Chlorine/Hydrogen Chloride/Sulfur Dioxide/Hydrogen Fluoride/ Hydrogen Sulfide/Permanently pre-attached P100 prefilter*	2
SE902	60924	Ammonia/Methylamine/P100	Ammonia/Methylamine/Permanently pre-attached P100 prefilter*	2
SE904	60926	Multi-Gas/Vapour/P100	Organic Vapours/Chlorine/Chlorine Dioxide/Hydrogen Chloride/ Ammonia/Methylamine/Sulfur Dioxide/Hydrogen Fluoride/Hydrogen Sulfide/ Formaldehyde/Permanently pre-attached P100 prefilter*	2
SE906	2071	P95 Filter	Grinding, sanding, bagging, welding, other oily/dusty operations	2
SE908	2078	P95 Filter w/Nuisance Level Organic Vapour and Acid Gas	Chemical manufacturing, welding, aluminum smelting	2
SE909	2091	P100 Filter	Welding, pharmaceutical manufacturing	2
SE910	2096	P100 Filter w/Acid Gas	Utility operations, chemical manufacturing aluminum smelting	2
SE911	2097	P100 Filter w/Organic Vapour	Welding, metal foundry, chemical manufacturing undercoating operations, pharmaceutical manufacturing	2



SDS613



SDS614



SE906

2300 N95 PARTICULATE RESPIRATORS

- Exhale valve reduces hot air build-up
- Dura-Mesh® shell resists collapsing
- Molded nose bridge easily seals without a metal nose band
- Soft foam nose cushion
- NIOSH approved N95
- 10 respirators per box
- **Sold per box**



Model No.	Mfg. No.	Description
SE849	2300N95	Medium/Large
SE850	2301N95	Small
SE851	2307N95	Alternate Shape

8511 N95 PARTICULATE RESPIRATORS

- Proprietary filter media helps make breathing easier
- 3M™ Cool Flow™ exhalation valve reduces heat build up
- Adjustable M-nose clip
- Braided comfort straps
- Lightweight construction
- NIOSH approved N95
- 10 respirators per box
- **Sold per box**

Model No. SE261
Mfg. No. 8511N95



8210 N95 PARTICULATE RESPIRATORS

- Excellent worker protection
- Proprietary filter media helps make breathing easier
- Lightweight construction
- Adjustable nose clip
- Welded strap attachment - no staples
- NIOSH approved N95
- 20 respirators per box
- **Sold per box**

Model No. SE260
Mfg. No. 8210N95



RESPIRATORY PROTECTION

NUISANCE DUST MASKS

- Provides protection against nuisance dusts such as pollen, animal dander, saw dust, and other non-toxic dusts
- Lightweight construction
- Adjustable nose clip provides a secure fit
- Latex straps
- Qty/Box: 50

Sold per Box
Model No. SAS499



FACE MASKS

- 3-ply non-woven polypropylene construction
- Adjustable nose clip provides a custom fit
- Latex-free
- Colour: Blue
- Qty/Pkg.: 50

Sold per Package
Model No. SDN589



N95 PARTICULATE FLAT FOLD RESPIRATORS

- Low breathing resistance for increased wearer comfort
- Adjustable plastic nose clip and soft foam nose piece provide a custom fit
- Medium/large
- Certification: NIOSH N95

Sold per Box



N95 PARTICULATE RESPIRATORS

- Provides excellent worker protection
- Lightweight construction for enhanced comfort
- Adjustable nose clip with soft foam nose piece provides a secure fit
- Dual rubber strap design
- Latex free
- SAS498 comes with exhalation valve for reduced humidity build up
- NIOSH approved N95

Sold per Box

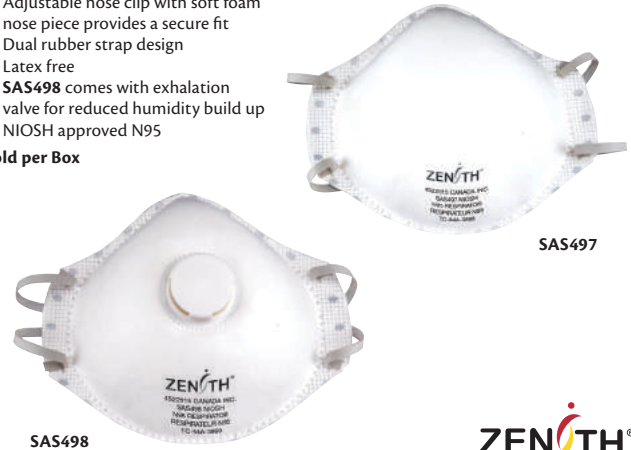

Model No.	Description	Qty /Box
SDN711	Without valve	20
SDN712	With valve	12

Model No.	Description	Qty /Box
SAS497	Without valve	20
SAS498	With valve	12

P100 PARTICULATE RESPIRATORS

- Contoured facial seal, fully adjustable head straps, and adjustable nose clip offer a comfortable secure fit
- Exhalation valve reduces hot air build up to facilitate breathing in humid environments
- Cup style
- Medium/Large
- Certification: NIOSH P100
- Qty/Box: 5

Sold per Package
Model No. SDN714



N100 PARTICULATE RESPIRATORS

- Contoured facial seal, fully adjustable head straps, and adjustable nose clip offer a comfortable secure fit
- Exhalation valve reduces hot air build up to facilitate breathing in humid environments
- Cup style
- Medium/Large
- Certification: NIOSH N100
- Qty/Box: 5

Sold per Box
Model No. SDN713



HEARING PROTECTION

FOAM EAR PLUGS

- Smooth foam ear plugs fit comfortably while blocking out unwanted noise
- Each pair is packaged for convenient access
- Brightly coloured for enhanced visibility
- Disposable
- One-Size
- Certification(s): ANSI S3.19-1974/CSA Class AL



Model No.	Style	NRR dB	Qty /Box
SFM648	Corded	32	100 prs.
SFM649	Uncorded	32	200 prs.
SFM650	Corded	30	100 prs.
SFM651	Uncorded	30	200 prs.

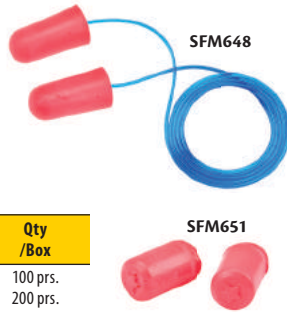

QUIET BANDS

Ergonomic design keeps the pods suspended so they do not become contaminated when you set the Quiet bands down.

QB2[®]HYG supra-aural protection has a NRR 25 dB rating

One free pair of replacement pods included with each Quiet band.



Model No.	Mfg. No.	Description
SN616	QB2HYG	Supra-Aural, 25 dB
REPLACEMENT PODS		
SN618	QB200HYG	1 pair per pkg.

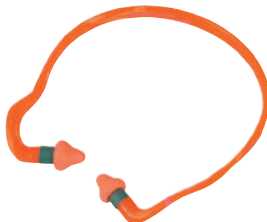

PLUGSTATION[®] EAR PLUG DISPENSERS

- Gives workers easy access to hearing protection
- Affordable enough to be placed near every work area
- Clicking mechanism for easier use and dispensing
- Chute delivers plugs right into the palm of your hand
- Eliminates the mess of individual paper/polybag packaging
- Each dispenser is sealed and disposable plus completely recyclable
- Mounting bracket with hardware included with every PlugStation[®]
- All rated at NRR 33 dB



SAK439



Model No.	Mfg. No.	Description	Qty /Dispenser
SE924	6644	SparkPlugs [®]	250 prs.
SE925	6645	SparkPlugs [®]	500 prs.
SE847	6844	Pura-Fit [®]	250 prs.
SF624	6845	Pura-Fit [®]	500 prs.
SAK439	6648	Camo Plugs [®]	500 prs.

LEIGHTNING[®] EARMUFFS

- Maximum protection from an earmuff
- Robust steel headband withstands demanding use
- Padded foam headband and super-soft ear cushions deliver longwearing comfort
- Contemporary design improves wearer compliance
- Telescoping height adjustment
- Hygiene kits available



Model No.	Mfg. No.	Description	NRR dB
SAK147	1010922	L1, Over-Head Headband	25
SAK149	1010924	L3, Over-Head Headband	30



LASER LITE[®] MULTI-COLOUR FOAM

- Vibrant colours make protection visible
- Self-adjusting polyurethane foam expands to fit virtually every wearer
- Contoured T-shape for easy insertion and wear
- Smooth, soil-resistant skin prevents dirt build-up
- Attenuation tested in accordance with ANSI S3.19-1974
- Rating: NRR 32 dB, CSA AL



Model No.	Mfg. No.	Description	Qty /Box
SM562	LL-1	Uncorded, Poly Bag	200 prs.
SM563	LL-30	Corded, Poly Bag	100 prs.



MAX[®] FOAM

- The world's most-used polyurethane foam ear plug
- Bell shape delivers maximum in-ear comfort
- Contoured design easier to insert, resists tendency to back-out of ear canal
- Polyurethane foam enhances comfort, especially for long-term wear
- Smooth, soil-resistant skin prevents dirt build-up
- Attenuation tested in accordance with ANSI S3.19-1974
- Rating: NRR 33 dB, CSA AL



Model No.	Mfg. No.	Description	Qty /Box
SD630	MAX-1	Uncorded	200 prs.
SD631	MAX-30	Corded	100 prs.

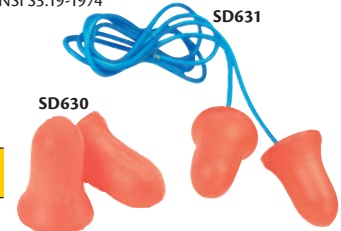

E-A-R[™] ULTRAFIT[™] PREMOLDED REUSABLE EARPLUGS

- Patented triple flange design to fit a wide variety of ear canal sizes
- Washable, promotes worker hygiene
- Breakaway cord protects in case of machine entanglement
- Rating: NRR 25 dB, CSA Class AL

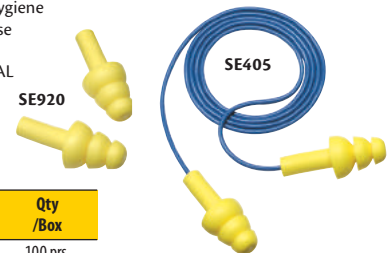

Model No.	Mfg. No.	Description	Qty /Box
SE920	340-4003	Uncorded	100 prs.
SE405	340-4004	Corded	100 prs.

THUNDER[®] EARMUFFS

- Non-deforming comfort headband fits all head sizes
- Ventilated inner headband and soft pads for maximum comfort
- Quick-Click height adjustments
- Dielectric design safe for electrical environments
- Features patented Air Flow Control[™] technology for optimal attenuation across all frequencies
- Snap-in ear cushion makes replacement quick and easy
- Hygiene kits available



Model No.	Mfg. No.	Description	NRR dB
SAK150	1010928	T1, Over-Head Headband	26
SAK151	1010929	T2, Over-Head Headband	28
SA0694	1011601	T1H, Cap Mount	23



EZ-STOP SHOCK ABSORBING LANYARDS

- Features the lightest, smallest, and strongest shock absorber in the world; 66% smaller and 40% lighter than previous EZ-stop models
- Lightest and strongest rebar hooks on the market
- Thinnest-ever webbing using HI-10™ Vectran® energy management material for reduced weight and bulk
- Vectran® is a multifilament high tenacity performance yarn spun from liquid crystal polymer that is five times stronger than steel
- Repel™ webbing repels water to reduce the attraction of mold and dirt
- High abrasion resistance
- Excellent chemical and cut resistance
- High impact resistance
- High visibility accents keep you safe in low-light conditions
- Protected labels for durability and longevity
- Rugged and durable soft shock absorber cover is designed to last
- Certified to CSA standard Z259.11-05, Class E4



SEJ423



Model No.	Mfg. No.	Length'	No. of Legs	Harness Connection	Anchorage Connections
SEJ418	1246012C	3	One	Snap Hook	Snap Hook
SEJ420	1246011C	6	One	Snap Hook	Snap Hook
SEJ421	1246102C	6	One	Snap Hook	Rebar Hook
SEJ423	1246024C	6	Two	Snap Hook	Rebar Hooks

REBEL™ WEB SELF-RETRACTING LIFELINES

- Web lifeline
- Self-locking hooks
- Great value with superior features
- Compact and lightweight
- Durable aluminum housing
- Certified to CSA standard Z259.2.2-98, Type 1 SRL



SEB350

SEB349

Model No.	Mfg. No.	Length'	Harness Connection	Anchorage Connection
SEB349	AD1108C	10	Swivel Snap Hook	Swivel Carabiner
SEB350	AD1208C	20	Rebar Hook	Swivel Carabiner

DURABUILT LANYARDS

- Energy absorbing lanyard
- Durable polyester construction
- Variety of constructions and configurations available
- Double locking snap hook harness connection
- Certified to CSA standard Z259.11-05, class E4

Model No.	Mfg. No.	Length'	Number of Legs	Anchorage Connections
CONTINUOUS WEB				
SAK520	FPD26311/4	4	One	Double Locking Snap Hook
SAK521	FPD26311/6	6	One	Double Locking Snap Hook
DECELERATOR				
SAH537	FPD29811/4	4	One	Double Locking Snap Hook
SAH750	FPD29811/6	6	One	Double Locking Snap Hook
SAH761	FPD29819/6	6	One	Double Locking Rebar Hook
SAK524	FPD2981G/4	4	One	Scaffolding Hook
SAK525	FPD2981G/6	6	One	Scaffolding Hook
DOUBLE-LEG DECELERATOR				
SAK528	FPD2991GG/4	4	Two	Scaffolding Hooks
SAK529	FPD2991GG/6	6	Two	Scaffolding Hooks



SAH750



MILLER® MANYARD® SHOCK-ABSORBING LANYARDS

- Unsurpassed in the market for safety, comfort and mobility
- Heavy-duty tubular outer jacket serves as a back-up web lanyard
- Locking snap hook harness connection
- Certified to CSA standard Z259.11-05, Class E4



SC980

Model No.	Mfg. No.	Length'	Anchorage Connection
SC980	216WLS-27/4FTYLC	4	Locking Snap Hook
SC982	216WLS-27/6FTYLC	6	Locking Snap Hook
SC984	219WRS-27/4FTYLC	4	Locking Rebar Hook
SC986	219WRS-27/6FTYLC	6	Locking Rebar Hook



DELTA™ HARNESSES

- Patented triangular no-tangle design
- Repel™ webbing is water repellent
- Lanyard keepers hold your unused snap hooks and help reduce trip hazards
- Spring-loaded stand-up dorsal D-ring
- Certified to CSA standard Z259.10-06, Class A



Model No.	Mfg. No.	Leg Connections
SEB391	1110600C	Quick-Connect
SEB406	1102000C	Tongue Buckle
SEB403	1103321C	Pass-Thru



SEB391

PRO™ HARNESSES

- Harness design provides greater comfort and added safety
- High quality alloy steel dorsal D-ring is adjustable for worker convenience
- Spring-loaded torso buckles provide fast and easy adjustment on the job
- Lightweight hardware reduces fatigue and increases comfort and productivity
- Lanyard keepers provide a place to "park" a lanyard
- Certified to CSA standard Z259.10-06, Class A



Model No.	Mfg. No.	Leg Connections	Additional Features
SEB363	1191201C	Pass-Thru	-
SEB366	1191237C	Tongue Buckle	-
SEB369	1191253C	Quick-Connect	Back, Shoulder, & Leg Padding Hip Pad & Belt
SEB360*	1191209C	Tongue Buckle	-

* CSA standard Z259.10-06, Class A, P



SEB369

RITE-ON™ HARNESSES

- Integrated back and shoulder pad
- Fast-action bayonet style connectors
- Sweat wicking pad fabric
- Tangle-free pad design
- Lightweight polyester webbing
- Universal size with full adjustability
- Certified to CSA standard Z259.10-06



Model No.	Mfg. No.	D-Rings	CSA Class
SAK490	FP81F/1DBA	Back	A
SAO635	FP81F/4EDLA	Extended-back, Side and Front	A, P, L



SAK490

MILLER ULTRA HARNESSES

- The new line of Ultra Harnesses is designed with patented DuraFlex® stretchable webbing that provides greater comfort, increases productivity and improves safety
- In addition, the DuraFlex® Python™ Ultra Harness also features cushioned tubular webbing in the shoulder straps to minimize possible discomfort around the neck and shoulders when required to wear a tool belt
- Comfort-touch back D-ring pad is designed with woven, breathable material for greater comfort; orients harness for quick tangle-free donning
- Sleek, quick-connect buckles for chest and leg straps for easy donning and feature a dual-tab release mechanism to prevent accidental opening
- Friction shoulder strap buckles stay firmly in place
- Universal fit
- Weight capacity: 400 lbs. (181.4 kg)
- Certified to CSA standard Z259.10



Model No.	Mfg. No.	D-Rings	CSA Class	Additional Features
DURAFLEX® ULTRA HARNESSES				
SAK309	E650QC/UGN	Back	A	-
SAK310	E650-7QC/UGN	Back and Side	A, P	-
SAK311	E650-77QC/UGN	Back and Side	A, P	Body Belt
DURAFLEX® PYTHON™ ULTRA HARNESSES				
SAK142	P950QC/UGN	Back	A	-
SAK307	P950-7QC/UGN	Back and Side	A, P	-
SAK308	P950-77QC/UGN	Back and Side	A, P	Body Belt



SAK308

LEATHER GLOVES

SUPERIOR QUALITY DOUBLE PALM SPLIT COWHIDE FITTERS GLOVES

- Top split cowhide leather construction
- Double layer of leather for premium protection
- Ultimate abrasion resistance
- Absorbent cotton lined palm
- Rubberized safety cuff provides superior protection
- Full leather tipped fingers and knuckle strap provides increased protection
- **Sold per pair**

SM579



Applications: Heavy-duty material handling, fabrication and metal handling

Model No.	Description	Size	Qty/Case
SM578	Outside Double Palm & Index Finger	Large	120
SM579	Outside Double Palm & Index Finger, 4" Gauntlet Cuff	Large	120
SD604	Outside Double Palm, Index Finger & Finger Tips	Large	60
SE349	Inside Double Palm & Index Finger	Large	120

SMOOTH GRAIN COWHIDE FURNITURE LEATHER GLOVES

- Smooth grain leather finish
- Resists oil and water
- Durable, tough furniture leather construction
- Cotton lined patch palm style
- Safety cuff provides added protection
- Case Qty: 120
- **Sold per pair**

Applications: Material handling, fabrication, metal handling and construction

Model No.	Size
SAN270	Large



THINSULATE™ LINED SPLIT COWHIDE FITTERS GLOVES

- Premium split cowhide leather construction
- Full Thinsulate™ lining provides superior warmth
- Good abrasion resistance
- Full leather tipped fingers and knuckle strap provides increased protection
- Rubberized cuff for ultimate protection
- Thinner lining than acrylic boa provides better dexterity
- **Sold per pair**

Applications: Extreme cold material handling, fabrication, metal handling and construction

Model No.	Size	Lining Weight g	Qty/Case
SAS500	Ladies	100	72
SAN637	Medium	100	60
SAL544	Large	40	72
SM609	Large	100	72
SAP248	X-Large	100	72
SAP249	2X-Large	100	72



GRAIN COWHIDE FITTERS ACRYLIC BOA-LINED GLOVES

- Premium grain cowhide leather construction
- Full acrylic boa lining provides superior warmth
- Superior abrasion resistance
- Resists oil and water absorption better than split leather
- Excellent comfort and durability
- Full leather tipped fingers and knuckle strap provides increased protection
- Rubberized cuff for ultimate protection
- Case Qty: 72
- **Sold per pair**

Applications: Extreme cold material handling, fabrication, metal handling and construction

Model No.	Description	Size
SAO053	Rubberized Safety Cuff	Large
SE1681	Ruberized Safety Cuff, Patch Palm	Large



SAO053



GRAIN COWHIDE PATCH PALM FITTERS GLOVES

- Smooth grain cowhide leather construction
- Superior abrasion resistance
- Excellent comfort and durability
- Absorbent cotton lined palm
- Resists oil and water absorption better than split leather
- Patch palm design delivers added savings
- Full leather tipped fingers and knuckle strap provides increased protection
- Case Qty: 120
- **Sold per pair**

Applications: Material handling, fabrication, metal handling and construction

Model No.	Description	Size
YC386	Standard Quality, Starched Cuff	Large
SAJ497	Better Quality, Plasticized Cuff	Large
SEC594	Better Quality, 4 3/4" Gauntlet Cuff	Large
SAP230	Better Quality, Rubberized Cuff	X-Large
SAP234	Superior Quality, Rubberized Cuff	X-Large



YC386



SUPERIOR QUALITY HI-VIZ SPLIT COWHIDE FITTERS GLOVES

- Good abrasion resistance
- Absorbent cotton lined palm
- Full leather tipped fingers and knuckle strap
- Fluorescent yellow back and two grey reflective stripes offer maximum visibility
- Rubberized safety cuff
- Case Qty: 120
- **Sold per pair**

Model No.	Size	Colour
SED160	Large	Fluorescent Yellow
SEK236	Large	Fluorescent Orange



SED160



SUPERIOR QUALITY HI-VIZ GRAIN COWHIDE FITTERS THINSULATE™ LINED GLOVES

- Premium construction
- 100-g Thinsulate™ liner provides superior warmth
- Superior abrasion resistance
- Excellent comfort and durability
- Resists oil and water well
- Full leather tipped fingers and knuckle strap
- Fluorescent yellow back and two grey reflective stripes offer maximum visibility
- Rubberized safety cuff
- Case Qty: 72
- **Sold per pair**

Model No.	Size	Colour
SED428	Large	Fluorescent Yellow
SEK237	Large	Fluorescent Orange



SED428



HYD-TUF® GLOVES

- Medium to heavy-duty nitrile coated
- Outperform standard cotton and leather gloves
- Nitrile coating resists snags, punctures, abrasions and cuts
- Excellent dry grip and repelling oil, grease and grime
- Snug and comfortable fit
- Safety cuff
- Accepted for use in Canadian food processing facilities
- **Sold per pair**

HYD-TUF 52-547 GLOVES

- Driver's style, with cloth back and soft jersey lining
- Case Qty: 144

HYD-TUF 52-590 GLOVES

- Medium to heavy-duty A.C.P. impregnated winter gloves
- Case Qty: 72

HYD-TUF 52-547

Model No.	Size
SAW956	9
SAW957	10



SAW956

HYD-TUF 52-590

Model No.	Size
SEA275	9
SEA276	10



MECHANICS/KNIT GLOVES

ZM100 MECHANIC GLOVES

- Ergonomic style and superior comfort
- Hook and loop cuff permits an adjustable fit
- Synthetic leather palm and fingers offer superior tactility and protection
- Improved dexterity, grip and durability
- Case Qty: 12
- **Sold per pair**

Applications: Automotive, small parts handling, maintenance, manufacturing, most industrial applications

Model No.	Size
SEB047	Medium
SEB048	Large
SEB049	X-Large
SEB050	2X-Large



ZENITH®
Safety Products

ZM200 MECHANIC GLOVES

- Ergonomic style combined with stylish look
- Hook and loop cuff permits an adjustable fit
- Synthetic leather palm and fingers offer superior tactility and protection
- Stretchable nylon on knuckles improves dexterity and comfort
- Textured patches on palm and thumb permits superior grip and durability
- Case Qty: 12
- **Sold per pair**

Applications: Automotive, small parts handling, maintenance, manufacturing, most industrial applications

Model No.	Size
SEB051	Medium
SEB052	Large
SEB053	X-Large
SEB054	2X-Large



ZENITH®
Safety Products

ZM300 MECHANIC GLOVES

- Ergonomic style and superior comfort
- Grain leather palm and fingers improve tactility and protection
- Hook and loop cuff permits an adjustable fit
- Leather reinforced thumb and fingers offer increased durability
- Improved dexterity and grip
- Case Qty: 12
- **Sold per pair**

Applications: Automotive, small parts handling, maintenance, manufacturing, most industrial applications

Model No.	Size
SEB228	Medium
SEB229	Large
SEB230	X-Large
SEB231	2X-Large



ZENITH®
Safety Products

ZM400 PREMIUM MECHANIC GLOVES

- Ergonomic style combined with stylish look and premium features
- Hook and loop cuff permits an adjustable and secure fit
- Reinforced Kevlar stitching for maximum strength and durability
- PVC dots on palm and fingers for an enhanced grip
- Stretchable nylon on knuckles improves dexterity and comfort
- Ventilation holes between fingers for maximum breathability
- Textured patches on palm, finger tips and thumb crotch increase protection and durability
- Case Qty: 12
- **Sold per pair**

Applications: Automotive, small parts handling, maintenance, manufacturing, most industrial applications

Model No.	Size
SEH739	Medium
SEH740	Large
SEH741	X-Large
SEH742	2X-Large



ZENITH®
Safety Products

ZM500 HI-VIZ CUT RESISTANT MECHANIC GLOVES

- Reinforced full palm HPPE liner that meets EN388 cut level 5
- Hi-viz yellow spandex back for maximum visibility
- Terry towel thumb for wiping perspiration
- Textured patches on palm, finger tips and thumb crotch increase protection and durability
- Ergonomic style combined with stylish look and premium features
- Hook and loop cuff permits an adjustable and secure fit
- Case Qty: 36

Sold per Pair

Applications: Automotive, small parts handling, maintenance, manufacturing, petrochemical and most industrial applications

ZENITH®
Safety Products

Model No.	Size
SDP433	Medium
SDP434	Large
SDP435	X-Large
SDP436	2X-Large



NATURAL POLY/COTTON DOTTED GLOVES

- 65% cotton and 35% polyester blend, 7-gauge
- PVC dots provide excellent grip and abrasion resistance
- Natural colour poly/cotton seamless string knit provides a cool comfortable fit
- Ambidextrous, single side dotted
- Accepted for use in Canadian food processing facilities
- Case Qty: 240
- **Sold per pair**

Applications: General maintenance, shipping and receiving, assembly and parts handling

Model No.	Size
SEE938	X-Small
SEE939	Small
SEE940	Medium
SEE941	Large
SEE942	X-Large



ZENITH®
Safety Products

POLY/COTTON STRING KNIT GLOVES

- Seamless string knit design provides excellent comfort and breathability
- 65% cotton and 35% polyester blend, 7 gauge
- Reversible pattern extends wear life and improves savings
- Knit wrist provides secure fit and prevents debris from entering the glove
- Accepted for use in Canadian food processing facilities
- Case Qty: 300
- **Sold per pair**

Model No.	Size
SEE932	X-Small
SEE933	Small
SEE934	Medium
SEE935	Large
SEE936	X-Large
SEE937	2X-Large



ZENITH®
Safety Products

COTTON CANVAS GLOVES

- Durable cotton fabric construction
- Moderate abrasion resistance
- Excellent comfort, dexterity and breathability
- Knit wrist eliminates dirt and debris from entering the glove
- Heavier weights provide enhanced protection and extended wear
- Case Qty: 300
- **Sold per pair**

Model No.	Fabric Weight Oz.	Size
SEE846	7	Large
SEE847	8	Medium
SEE848	8	Large
SEE849	8	X-Large
SEE850	12	Large



ZENITH®
Safety Products

COATED GLOVES

NATURAL RUBBER LATEX PALM COATED GLOVES

- 10-gauge seamless knitted poly/cotton shell
- Textured coating provides superior wet and dry grip
- Exceptional comfort and fit
- Resists abrasion, cuts and punctures
- Knit wrist prevents debris from entering the glove
- Palm coating provides a cool comfortable fit
- Case Qty: 120 • **Sold per pair**

Model No.	Size
SEB865	7
SAL255	8
SAL256	9
SAL257	10
SAL258	11



HIGH VISIBILITY NATURAL RUBBER LATEX PALM-COATED ACRYLIC-LINED GLOVES

- 100% acrylic thermal liner offers superior cold protection
- 7-gauge seamless terry knitted and brushed lining
- Resists abrasions, cuts and punctures
- Exceptional comfort and fit
- Natural rubber latex palm coating
- Uncoated back permits breathability and limits perspiration
- Fluorescent yellow shell and blue coating offer maximum visibility
- Crinkle finish coating provides superior wet and dry grip
- Case Qty: 60 • **Sold per pair**

Applications: Fishing industry, cold/outdoor environments, glass/wood handling, masonry and general maintenance.

Model No.	Size
SEC797	7
SEC798	8
SEC799	9
SEC800	10
SEC801	11



WINTER MONKEY GRIP® GLOVES

- PVC-coated foam-insulated
- Tough PVC coating stays soft when cold
- Keep hands warm and dry
- Protect from abrasion
- Curved fingers, wing thumb, and soft jersey lining make them very comfortable
- Fully coated
- Accepted for use in Canadian food processing facilities
- Case Qty: 72 • **Sold per pair**

Applications: Cold storage, winter transportation, yard and field work, unheated warehouses, construction

Model No.	Description
SBA992	Knit Wrist
SBA993	Safety Cuff
SEE953	Raised Finish, Safety Cuff



ZX-2 PREMIUM 3/4 NITRILE & NITRILE FOAM PALM COATED GLOVES

- Black foam nitrile palm coating for maximum grip in dry, wet and oily conditions
- Purple flat nitrile 3/4 coating to prevent liquids from permeating through the glove shell
- Grey seamless nylon/spandex 18-gauge shell for maximum dexterity
- Premium comfort and breathability reduces hand fatigue
- Knit wrist prevents dirt and debris from entering the glove
- Gauge: 18 • Liner: Nylon
- Unlined • Case Qty: 144

Applications: Automotive, small parts handling, assembly and maintenance, manufacturing, wet/oily applications
Sold per pair

Model No.	Size
SDP444	7
SDP445	8
SDP446	9
SDP447	10
SDP448	11



NITRILE PALM COATED GLOVES

- Seamless nylon knit provides ultimate dexterity and reduces hand fatigue
- Premium comfort and breathability
- Superior abrasion, cut and puncture resistance
- Excellent dry grip
- Durable nitrile-coated palm
- Knit wrist
- Case Qty: 120
- **Sold per pair**

Model No.	Size
GREY ON BLACK	
SAP931	7
SAP932	8
SAP933	9
SAP934	10
SAP935	11

Model No.	Size
BLACK ON WHITE	
SAO157	7
SAO158	8
SAO159	9
SAO160	10
SAP355	11



LIGHTWEIGHT POLYURETHANE PALM COATED GLOVES

- Seamless nylon knit provides ultimate dexterity and reduces hand fatigue
- Premium comfort and breathability
- Superior dry grip
- Excellent abrasion resistance
- Ultra soft polyurethane palm coated
- Knit wrist eliminates dirt and debris from entering the glove
- Case Qty: 120 • **Sold per pair**

White Model No.	Black Model No.	Size
SAO161	SAX694	6
SAO162	SAX695	7
SAO163	SAX696	8
SAO164	SAX697	9
SAO165	SAX698	10
SAO166	SAX699	11



NATURAL RUBBER LATEX COATED GLOVES

- Natural rubber latex palm coating
- 13-gauge seamless knitted polyester shell provides a comfortable fit
- Resists abrasion, cuts and punctures
- Crinkle finish coating provides superior wet and dry grip
- Knit wrist prevents debris from entering the glove
- Gauge: 13 • Liner: Polyester
- Coating: Rubber Latex • Lining: Unlined
- **Sold per Pair** • Case Qty: 120

Applications: Glass handling, construction, wood handling, automotive, masonry and general maintenance/manufacturing

Model No.	Size
SFM541	Small (7)
SFM542	Medium (8)
SFM543	Large (9)
SFM544	X-Large (10)



MEDIUMWEIGHT NITRILE COATED GLOVES

- Interlock cotton lining
- Superior abrasion, cut and puncture resistance
- Excellent comfort and breathability
- Greater dexterity than heavyweight
- Open back coating provides a cool and comfortable fit
- Knit wrist eliminates dirt and debris from entering the glove
- Case Qty: 120
- **Sold per pair**

Model No.	Size
SAO150	7
SAO151	8
SAO152	9
SAO153	10
SAO154	11



CUT RESISTANT GLOVES

HPPE POLYURETHANE-COATED GLOVES

- Stretchable seamless HPPE liner
- HPPE (high performance polyethylene) liner is an extremely strong fibre
- Breathable polyurethane palm coating
- Superior cut, abrasion, and tear resistance
- Elastic knit wrist
- Provides a superior grip
- Cut resistance: ANSI/ISEA 105 Level 4/EN 388 Level 5
- Case Qty: 144
- **Sold per pair**



SEF168

Model No.	Size
SEF166	7
SEF167	8
SEF168	9
SEF169	10
SEF170	11

NITRILE COATED KEVLAR® GLOVES

- Stretchable seamless 13-gauge Kevlar® liner
- Nitrile palm coating
- Excellent cut, abrasion and tear resistance
- Elastic knit wrist
- Wrinkle finish provides a superior grip
- Meets EN388 Level 4 for cut resistance
- Case Qty: 120
- **Sold per pair**



SAP923



Applications: Component assembly, waste handling, automotive and metal handling

Model No.	Size	Model No.	Size
SEC137	7	SAP925	10
SAP923	8	SAP926	11
SAP924	9	SEC138	12

LATEX COATED KEVLAR® GLOVES

- Natural rubber latex palm coating
- Seamless 10-gauge Kevlar® liner
- Excellent cut, tear and puncture resistance
- Elastic knit wrist
- Wrinkle finish provides a superior grip
- Meets EN388 Level 4 for cut resistance
- Case Qty: 144
- **Sold per pair**



SAP927



Applications: Material handling, automotive, glass handling and waste handling

Model No.	Size	Model No.	Size
SAP927	8	SAP929	10
SAP928	9	SAP930	11

HPPE NITRILE-COATED GLOVES

- Stretchable seamless liner
- Breathable nitrile palm coating
- Excellent abrasion and tear resistance
- Elastic knit wrist
- Meets EN388 Level 3 for cut resistance
- Accepted for use in Canadian food processing facilities
- Case Qty: 144
- **Sold per pair**



SEB090



Model No.	Size	Model No.	Size
SEB090	7	SEB093	10
SEB091	8	SEB094	11
SEB092	9		

HYFLEX® 11-501 GLOVES

- Intercept Technology™ yarn liner developed by Ansell and Dupont™
- Lightweight fit and feel with superior cut resistance
- Outstanding dexterity
- Superior oil grip, tactile sensitivity, dexterity and comfort
- Cut prevention improves productivity and profitability
- Teal foam nitrile palm coating
- Accepted for use in Canadian food processing facilities
- Meets ANSI/ISEA 105 Level 4, EN388 Level 4 for cut resistance
- Case Qty: 144
- **Sold per pair**



SAW951



Applications: Automotive assembly, sheet metal assembly, handling sharp small parts, handling glass

Model No.	Size	Model No.	Size
SAW951	6	SAW954	9
SAW952	7	SAW955	10
SAW953	8		

HY-FLEX® 11-518 GLOVES

- Blue polyurethane palm coating
- New Dyneema® Diamond Technology HPPE yarn offers an unmatched combination of cut protection, comfort and dexterity in an 18-gauge glove
- Soft, sheer Dyneema® Diamond fibre breathes to keep hands cool and dry and moves freely with the motion of the hand for a more comfortable fit
- Polyurethane coating provides a sure grip in light oil and dry applications and excellent resistance to abrasion
- The ultralight fabric and tailored fit of the 11-518 create a barehand-like sensation of contact when performing tasks that demand high tactility
- ANSI level 2 cut protection, EN388 level 3 for cut resistance
- Case Qty: 144
- **Sold per pair**



SEI847



Applications: Handling/Assembly of small or ultra-fine dry sharp parts, packaging areas with risk of cut, wiring

Model No.	Size
SEI847	Small
SEI848	Medium
SEI849	Large
SEI850	X-Large

HYFLEX® 11-624 GLOVES

- Advanced cut protection with ergonomic design
- Dyneema®, Spandex® and nylon liner combined for excellent dexterity
- Yarn combination molds naturally to prevent hand fatigue
- Polyurethane coating provides a sure grip in dry and light oil applications
- Meets ANSI/ISEA 105 Level 2, EN388 Level 3 for cut resistance
- Accepted for use in Canadian food processing facilities
- Case Qty: 144
- **Sold per pair**



SAW989



Applications: Assembly areas for use when handling metal components, glass handling and installation, small parts stamping, forming, machining and bending of small parts

Model No.	Size	Model No.	Size
SAW989	6	SAW992	9
SAW990	7	SAW993	10
SAW991	8	SAW994	11

HYFLEX® 11-627 GLOVES

- Dyneema® innovative yarn liner with polyurethane coating
- Exceptional cut resistance with an optimal level of Dyneema®
- Lycra® and nylon combined for excellent dexterity
- Polyurethane palm coating for excellent grip
- Meets ANSI/ISEA 105 Level 1/EN388 Level 3 for cut resistance
- Accepted for use in Canadian food processing facilities
- Case Qty: 144
- **Sold per pair**



SAY080



Applications: Applications, automotive, metal, glass, aeronautics, white goods manufacturing

Model No.	Size	Model No.	Size
SAY080	6	SAY083	9
SAY081	7	SAY084	10
SAY082	8		

DISPOSABLE/CHEMICAL RESISTANT GLOVES

EXAMINATION GRADE NITRILE

- Pure 100% premium nitrile
- Textured surface provides superior wet and dry grip
- Exceptional tactile sensitivity
- USP grade corn starch for powdered gloves
- Beaded cuff for added strength
- Protects against oil, grease and organic solvents
- Superior puncture resistance

- Latex-free
- Ambidextrous design
- Not for medical use
- 9.5" length
- AQL 1.5
- Accepted for use in Canadian food processing facilities
- Case Qty: 10

Sold per Box of 100 Gloves

Applications: Manufacturing, maintenance, small parts handling, laboratory applications and automotive

Model No.	Size	Model No.	Size	Model No.	Size
4-MIL, POWDERED			4-MIL, POWDER-FREE		
SEA916	X-Small	SEA918	X-Small	SDM041	Small
SAP320	Small	SAP324	Small	SDM042	Medium
SAP321	Medium	SAP325	Medium	SDM043	Large
SAP322	Large	SAP326	Large	SDM044	X-Large
SAP323	X-Large	SAP327	X-Large	SDM268	2X-Large
SEA917	2X-Large	SEA919	2X-Large		

ZENITH®
Safety Products



BLACK NITRILE GLOVES

- Textured fingertips provide superior wet and dry grip
- 8-mil glove has fully textured diamond pattern
- Beaded cuff for added strength
- Superior puncture and tear resistance
- Excellent tactile sensitivity and dexterity
- Latex-free
- Ambidextrous design
- AQL 1.5
- Powder-free
- Case Qty: 10 boxes

Applications: Manufacturing, maintenance, small parts handling, laboratory and automotive, law enforcement

4 MILS - Sold per box of 100 gloves

Model No.	Size
SEB085	Small
SEB086	Medium
SEB087	Large
SEB088	X-Large
SED981	2X-Large

8 MILS- Sold per box of 50 gloves

Model No.	Size
SEK261	Small
SEK262	Medium
SEK263	Large
SEK264	X-Large
SEK265	2X-Large

ZENITH®
Safety Products



EXAMINATION GRADE VINYL GLOVES

- Pure 100% premium vinyl
- Exceptional fingertip sensitivity
- Soft and stretchable for comfortable wear
- USP grade corn starch for powdered gloves
- Beaded cuff for added strength
- Ambidextrous design
- 4 mils, AQL 1.5
- 9.5" length
- Accepted for use in Canadian food processing facilities
- **Not for medical use**
- Case Qty: 10 boxes
- **Sold per box of 100 gloves**

Applications: Light manufacturing, maintenance, food processing, laboratory applications, painting and janitorial

Model No.	Size	Model No.	Size
POWDERED		POWDER-FREE	
SAP328	X-Small	SAP333	X-Small
SAP329	Small	SAP334	Small
SAP330	Medium	SAP335	Medium
SAP331	Large	SAP336	Large
SAP332	X-Large	SAP337	X-Large



SAP328

EXAMINATION GRADE NITRILE GLOVES

- Pure 100% premium nitrile
- Textured surface provides superior wet and dry grip
- Exceptional tactile sensitivity
- Latex-free
- USP grade corn starch for powdered gloves
- Beaded cuff for added strength
- Protects against oil, grease and organic solvents
- Superior puncture resistance
- Ambidextrous design
- 4 mils, AQL 1.5
- 9.5" in length
- Accepted for use in Canadian food processing facilities
- **Not for medical use**
- Case Qty: 10 boxes
- **Sold per box of 100 gloves**

Applications: Manufacturing, maintenance, small parts handling, laboratory applications and automotive

Model No.	Size	Model No.	Size
POWDERED		POWDER-FREE	
SEA916	X-Small	SEA918	X-Small
SAP320	Small	SAP324	Small
SAP321	Medium	SAP325	Medium
SAP322	Large	SAP326	Large
SAP323	X-Large	SAP327	X-Large
SEA917	2X-Large	SEA919	2X-Large



SAP320

ZENITH®
Safety Products

PVC SMOOTH FINISH GLOVES

- Bright red PVC on cotton interlock lining
- Resistant to most oils, acids, greases and solvents
- Ideal for general chemical handling
- Colour: Red
- Case Qty: 120
- **Sold per pair**

Applications: Fisheries, general maintenance, petrochemical industry

Model No.	Description
SEE804	12" Gauntlet
SEE805	14" Gauntlet
SEE806	Knit Wrist



SEE804

ZENITH®
Safety Products

FLOCK-LINED GREEN NITRILE GLOVES

- Cotton flock lined
- Raised diamond pattern provides superior grip
- Resistant to cuts, puncture and abrasion
- Accepted for use in Canadian food processing facilities
- 13" length, 15-mil thick
- Case Qty: 120
- **Sold per pair**

Applications: Food processing, plant maintenance, chemical processing, automotive and printing

Model No.	Size
SEF083	7
SEF084	8
SEF085	9
SEF086	10
SEF087	11



SEE085

ZENITH®
Safety Products

VALUE MASTER® NATURAL RUBBER GLOVES

- Provides unequalled value, comfort and flexibility, outstanding tactile sensitivity, strength, dexterity and elasticity
- Form-fitting 100% natural rubber-latex
- Features a self-flushing tractor-tread pattern that provides an excellent grip, wet or dry, and encourages run-off of fluids often trapped by diamond-shaped embossed patterns
- 12" length, 18-mil thick
- Resists a wide range of chemicals, including animal fats, caustics, acids, oils, salts, alcohols and detergents
- Case Qty: 144
- **Sold per pair**

Model No.	Mfg. No.	Description	Size
SA627	VM-S	Flock Lined, 12"	Small
SA626	VM-M	Flock Lined, 12"	Medium
SA625	VM-L	Flock Lined, 12"	Large
SA628	VM-XL	Flock Lined, 12"	X-Large



SA626

SHOWA
Always Innovating. Never Imitating.

PROTECTIVE CLOTHING

RZ300 RAIN SUITS

- 0.20 mm material thickness
- Unsupported yellow PVC material with an embossed finish
- Jacket features storm flap and dome snaps, two patch pockets and a detachable hood
- Bib overall pants feature fly front
- Ankle and cuff take-up snaps
- Non-conductive fasteners
- Ultrasonically welded seams

Model No.	Size
SEH092	Small
SEH093	Medium
SEH094	Large
SEH095	X-Large
SEH096	2X-Large
SEH097	3X-Large
SEH098	4X-Large



RZ100 RAIN SUITS

- 0.35-mm material thickness
- Yellow triple layer PVC/polyester/PVC material
- Jacket features storm flap, dome snaps, two patch pockets, corduroy collar and detachable hood
- Cape back and underarm vents
- Bib overall pants feature non-conductive fasteners, fly front and adjustable suspenders
- Ankle and cuff take-up snaps
- Adjustable waist snaps
- Ultrasonically-welded seams

Model No.	Size
SEH078	Small
SEH079	Medium
SEH080	Large
SEH081	X-Large
SEH082	2X-Large
SEH083	3X-Large
SEH084	4X-Large



RZ900 PREMIUM TRAFFIC RAIN SUITS

- 0.35 mm thick Hi-Viz lime-yellow dual layer laminated PVC/Polyester
- 3M™ Scotchlite™ reflective material for maximum visibility
- 2" reflective stripes
- Jacket features storm flap, dome fasteners, two patch pockets, corduroy collar and detachable hood
- Bib overalls feature fly front, adjustable suspenders and adjustable waist snaps
- Non-conductive fasteners
- Ultrasonically-welded seams
- Meets CSA standard Z96-02 standard, Class 3, Level 2 requirements

Model No.	Size
SEH113	Small
SEH114	Medium
SEH115	Large
SEH116	X-Large
SEH117	2X-Large
SEH118	3X-Large
SEH119	4X-Large



RZ500 FLAME RESISTANT RAIN SUITS

- 0.30-mm material thickness
- Yellow tear-resistant PVC/nylon/PVC material
- Lightweight material offers greater flexibility and comfort
- Jacket comes with storm flap, dome snap fasteners, two patch pockets and detachable hood
- Cape back vent on jacket with underarm vents
- Bib overalls feature fly front, adjustable suspenders and adjustable waist snaps
- Ankle and cuff take-up snaps
- Non-conductive fasteners
- Ultrasonically-welded seams
- Compliant with CSA testing under CAN/CGSB standard 155.20 for flame resistance

Model No.	Size
SEH099	Small
SEH100	Medium
SEH101	Large
SEH102	X-Large
SEH103	2X-Large
SEH104	3X-Large
SEH105	4X-Large



POLYETHYLENE APRONS & SLEEVES

- Thickness: 0.02 mm
- ### APRONS
- Bib style
 - Disposable polyethylene apron with waist ties
 - Dimensions: 35" x 46"
 - 100/pkg.



SEK350



SEK351

- ### SLEEVES
- Elastic at both ends
 - Length: 16"



Model No.	Description	Qty /Pkg.
SEK351	Apron	100
SEK350	Sleeve	100

APRONS

- Bib-style aprons
- Cotton straps for adjustability
- Vinyl aprons feature seamless edges to prevent residue and bacteria accumulation
- Denim aprons feature one chest pocket and three waist pockets
- Accepted for use in Canadian food processing facilities



SEE888



SEE852

Model No.	Fabric	Dimensions L" x W"	Colour
SEE888	0.20 mm Lightweight Vinyl	45 x 36	Blue
SEE852	10 oz. 100% Cotton Canvas	36 x 29	White
SEE851	10 oz. Denim	38 x 28	Blue

BOUFFANT CAPS

- Non-woven polypropylene
- Elasticized band for an optimum fit
- 100% latex-free
- Sold per package

SEC376



Model No.	Size	Colour	Qty /Pkg.
SEC375	Medium 18"	White	100
SEC376	Large 21"	White	100
SEC377	X-Large 24"	White	100
SEC378	Large 21"	Blue	100
SEN410	X-Large 24"	Blue	100

NON-CONDUCTIVE SHOE COVERS

- 100% spun-bonded polypropylene
- Elasticized band for an optimum fit
- Flexible material permits easy movement
- Sewn seams offer maximum tear strength
- Skid-free model has a textured sole for improved traction
- Colour: Blue
- Sold per package

SEC391



SEC389



Model No.	Description	Size	Qty /Pkg.
SEC389	Regular Sole	Large	100
SEC390	Regular Sole	X-Large	100
SEC391	Skid-Free Sole	X-Large	100

PROTECTIVE CLOTHING

SMS HOODED COVERALLS

- Three layer polypropylene SMS (spun-bonded, melt-blown, spun-bonded)
- Offers protection against toxic particles and water-based liquids
- Double outer layer offers greater protection against tearing and abrasion
- Lightweight and flexible fabric permits superior comfort and breathability
- Zipper front with storm flap, attached hood, elastic wrists and ankles
- Available in white or navy blue
- Fabric weight: 1.80 oz/yd² (60 grams)
- Case Qty: 25

Applications: Food processing, laboratories/pharmaceutical, light oil and grease, maintenance, manufacturing/assembly, refineries/chemical producers.



White Model No.	Navy Model No.	Size
SEC841	SEC847	Medium
SEC842	SEC848	Large
SEC843	SEC849	X-Large
SEC844	SEC850	2X-Large
SEC845	SEC851	3X-Large
SEC846	SEC852	4X-Large

POLYPROPYLENE HOODED COVERALLS

- Polypropylene permits breathability and comfort
- Offers protection against non-hazardous and non-toxic, liquid, dust and particles
- Economical disposable option for protection in grimy work environments
- Elastic wrists, ankles and hood
- Case Qty: 50

Applications: Food processing, laboratories/pharmaceutical, warehouses, maintenance, manufacturing/assembly, dusty environments.



STANDARD

- Front zipper for optimum fit
- 1.6 oz/m² fabric

Model No.	Size
STANDARD COVERALLS	
SEK356	Medium
SEK357	Large
SEK358	X-Large
SEK359	2X-Large
SEK360	3X-Large
SEK361	4X-Large
SEK362	5X-Large

PREMIUM

- Heavy-duty front zipper for optimum fit
- Heavy-duty front zipper flap
- Features front left breast pocket
- 2.1 oz/m² fabric

Model No.	Size
PREMIUM COVERALLS	
SEK370	Medium
SEK371	Large
SEK372	X-Large
SEK373	2X-Large
SEK374	3X-Large
SEK375	4X-Large
SEK376	5X-Large

MICROPOROUS COVERALLS

- Microporous film laminated to a polypropylene substrate
- Offers protection against liquid, dust and light chemical splashes
- High quality microporous fabric provides comfortable fit and breathability
- Can be used in dry and wet work environments
- Passed penetration tests with Diazinon, motor oil, bleach, isocyanate based paint, sodium hydroxide, sodium hypochlorite and blood
- Fabric weight: 1.85 oz/yd² (63 grams)
- Case Qty: 25

Applications: Asbestos and lead abatement, clean rooms, radioactive dirt and dust, printing, refineries/chemical producers, maintenance, crime scenes, painting



Model No.	Description	Size
COVERALLS		
SEC807		Small
SEC808	Zipper front	Medium
SEC809	w/storm flap,	Large
SEC810	elastic wrists	X-Large
SEC811	and ankles	2X-Large
SEC812		3X-Large
SEC813		4X-Large

Model No.	Description	Size
HOODED COVERALLS		
SEC814		Small
SEC815	Zipper front	Medium
SEC816	w/storm flap,	Large
SEC817	attached hood,	X-Large
SEC818	elastic wrists	2X-Large
SEC819	and ankles	3X-Large
SEC820		4X-Large

TYVEK® 400 COVERALLS

- The best balance of protection, durability and comfort
- Inherent barrier protection against dry particulate hazards
- Even after abrasion, stops sub-micron particles better than reusable garments
- Case Qty: 25

Applications: General maintenance/operations, spray painting, lead abatement, environmental cleanup, asbestos abatement, agriculture, food processing, mold remediation, micro crystalline silica.



Model No.	Mfg. No.	Size
COVERALLS		
SAS035	TY125S-M	Medium
SAS036	TY125S-L	Large
SAS037	TY125S-XL	X-Large
SAS038	TY125S-2XL	2X-Large
SAS039	TY125S-3XL	3X-Large
SAS040	TY125S-4XL	4X-Large

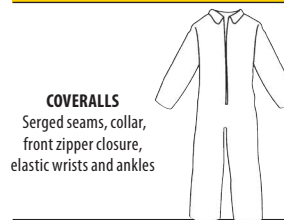

COVERALLS
Serged seams, collar, front zipper closure, elastic wrists and ankles



HOODED COVERALLS
Serged seams, attached hood, front zipper closure, elastic wrists and ankles

SAS042	TY127S-M	Medium
SAS043	TY127S-L	Large
SAS044	TY127S-XL	X-Large
SAS045	TY127S-2XL	2X-Large
SAS046	TY127S-3XL	3X-Large
SAS047	TY127S-4XL	4X-Large

TRAFFIC VESTS

- High-visibility lightweight polyester mesh provides daytime visibility
- 2" yellow reflective stripes provide 360° nighttime visibility
- 5-point tear-away features on shoulders, sides and front for easy quick release



Model No.	Size
SEF093	Medium
SEF094	Large
SEF095	X-Large
SEF096	2X-Large

TRAFFIC SAFETY VESTS

- Lightweight and comfortable fluorescent orange or fluorescent lime-yellow sports mesh knit fabric provides daytime visibility
- 2" silver reflective stripes offer maximum nighttime visibility
- Front hook and loop enclosure permits optimal fitting
- Machine washable
- Meets CSA standard Z96-09, Class 2, Level 2 requirements



Model No.		Size
Orange	Lime-Yellow	
SEB698	SEB702	Medium
SEB699	SEB703	Large
SEB700	SEB704	X-Large
SEB701	SEB705	2X-Large

PREMIUM POLYESTER T-SHIRTS

- Moisture wicking, lightweight, soft and breathable fabric
- Fluorescent lime-green 100% polyester "bird's eye" mesh material
- 3" fluorescent orange/silver dual reflective stripes
- Upper left breast pocket with hook and loop closure
- Two radio loops
- Machine washable
- Meets CSA standard Z96-09, Class 2, Level 2 requirements



Model No.		Size
Orange	Lime-Yellow	
SEF109	SEL243	Medium
SEF110	SEL244	Large
SEF111	SEL245	X-Large
SEF112	SEL246	2X-Large

TRAFFIC HARNESSSES

- 1 1/2" lime-yellow/silver reflective stripes
- Elasticized material permits optimal fit
- Four strap adjusters and front clip for maximum adjustability

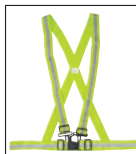

Model No.	Size
SEF117	Medium
SEF118	Large
SEF119	X-Large
SEF120	2X-Large
SEF121	3X-Large



5-POINT TEAR-AWAY TRAFFIC SAFETY VESTS

- Lightweight and comfortable fluorescent orange sports mesh knit fabric provides daytime visibility
- 2" yellow reflective stripes provide 360° nighttime visibility
- 5-point tear-away features on shoulders, sides and front for easy quick release
- Meets CSA standard Z96-09, Class 2, Level 2 requirements



Model No.	Size
SEF097	Medium
SEF098	Large
SEF099	X-Large
SEF100	2X-Large

SURVEYOR TRAFFIC SAFETY VESTS

- Lightweight and comfortable fluorescent orange sports mesh knit fabric provides daytime visibility
- 4" yellow/silver reflective stripes offer maximum nighttime visibility
- 5-point tear-away features on shoulders, sides and front for easy quick release
- Safety D-ring access slot
- Two top hook and loop sealed pockets and two bottom open pockets
- Two radio loops
- Machine washable
- Meets CSA standard Z96-09, Class 2, Level 2 requirements



Model No.		Size
Orange	Lime-Yellow	
SEF101	SEK232	Medium
SEF102	SEK233	Large
SEF103	SEK234	X-Large
SEF104	SEK235	2X-Large

ARM & LEG BANDS

- 2" lime-yellow/silver reflective bands
- Hook and loop closure permits optimal fit
- Available in various lengths



Model No.	Length"
SEF122	10
SEF123	12
SEF124	13 1/2
SEF125	15
SEF126	17
SEF127	19



EMERGENCY EYEWASH STATIONS

CEDEROTH® EYEWASH

- Easy-to-use bottle with an ergonomic eye cup and a generous flow of fluid
- Opens using one easy twisting motion
- Integral dust cover keeps the eye cup clean and acts as an opening device
- Buffered eye wash solution has a neutralising effect on splashes from acids or alkalis
- Does not meet ANSI standard Z358.1-2009 15-minute flushing requirement

SAY472
& SAY473



SAY474



Model No.	Mfg. No.	Description
SAY472	04100	235 ml Bottle
SAY473	04101	Holster for SAY472
SAY474	04102	500 ml Bottle
SAY475	04103	Wall Bracket for SAY474
SAY476	04104	Strap for Wall Bracket
SEB188	04106	Portable Wall Case, Five 500 ml Bottles
SFM478	14390	Wall bracket for SEB188

FENDALL PURE FLOW 1000® EYEWASH STATIONS

- Sure-grip handle provides instant activation
- Activation straps display expiration date
- Integral drain valve and fluid reservoir
- Automatically displays "Warning Service Immediately" once activated
- Requires two 3.8 gallon Eyesaline® fluid cartridges (sold separately)
- Comes complete with product registration card, operating manual, metal hanging bracket for installation and an emergency eye wash sign
- SEI certified to meet ANSI standard Z358.1-2009



Honeywell

Model No.	Mfg. No.	Description
SD552	32-001000-0000	Eyewash Station (English Instructions)
SAJ678	32-001000-0022	Eyewash Station (French Instructions)
SD553	32-001050-0000	Fluid Cartridges (2/pkg)

ON-SITE® GRAVITY-FED EYEWASH STATIONS

- Ideal for locations where a plumbed water source is not available
- High-visibility yellow, molded pedestal and tank
- Transparent tank allows solution level to be checked easily
- Hinged eyewash tray activates in one quick motion
- Stainless steel clamps secure the tank
- Vandal-resistant unit: foreign objects cannot be introduced into tank
- SEI certified to ANSI standard Z358.1-2009
- Includes wall bracket (can also deck mount)

SAK609



SAK611

ON-SITE® WASTE CARTS

- Captures used fluid, 56-gallon capacity
- Tapered sump, easy to drain

Bradley

Model No.	Mfg. No.	Description
SAK609	S19-921	Gravity-Fed Eyewash
SAK611	S19-399	Waste Cart

FAUCET-MOUNT EYEWASH STATIONS

- Cost effective solution for applications with an existing faucet
- Mounts to standard or gooseneck type faucets
- Twin spray heads include a flow control and pop-off dust covers
- One-step activation
- Faucet can be used for normal operation
- Includes a safety sign and inspection tag
- Weight: 1 lb.
- SEI certified to ANSI standard Z358.1-2009

Model No. SAK621
Mfg. No. S19-200B

Bradley

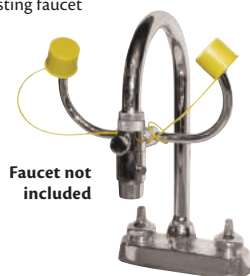

Faucet not included

FENDALL PORTA STREAM® II & III EYEWASH STATIONS

- Versatile portability without costly plumbing
- Simple installation and operation
- Features a nozzle strap that is easily removed to activate flushing
- Molded handle accepts hanging bracket for vertical or horizontal surface installation
- Versatile flushing fluid options include Eyesaline® - a preserved, buffered, saline solution superior to tap water for emergency eye care, and Fend-all water additive
- Large 16-gallon (60.5 L) capacity
- SEI certified to meet ANSI standard Z358.1-2009



SA427

Honeywell

Model No.	Mfg. No.	Description
SEK529	32-000200-0000	Eyewash (Trilingual instructions)
SA411	32-000513-0020	Eyesaline® Concentrate, 180 oz.
SAJ677	32-001100-0022	Water Preservative, 8 oz. Bottles, 4/Case
SA426	32-000102-0000	Replacement Pull-Strap

9-GALLON PORTABLE EYEWASH STATIONS

- 9-gallon high density green polyethylene tank made from FDA approved materials
- Gravity fed
- Easy-to-operate yellow activation arm protects eyewash spouts when not in use
- Wide-fill opening with threaded cap
- Light design and mounting bracket (included)
- Freeze-Protection version SFV126 ideal for remote, low traffic area's
- Certified by CSA to meet ANSI standard Z358.1-2009



Haws

Model No.	Mfg. No.	Description
SAR314	7501	Portable Gravity Eyewash Fountain
SAR315	9082	Bacteriostatic Water Preservative, 5 oz., 4/Case
SFV126	7501T	Freeze-Protection and Tempered Gravity Eyewash Station, 120V
SFV127	7501T240	Freeze-Protection and Tempered Gravity Eyewash Station, 240V

WALL-MOUNT AXION MSR® EYE/FACE WASH STATIONS

- Provides a zero vertical velocity stream for enhanced comfort, stability, and effectiveness
- Wall mounts with an aluminum bracket
- 11" diameter bowl
- Mesh strainer collects debris
- Certified by CSA to meet ANSI standard Z358.1-2009

Haws
AXION
msr



SEB239

Model No.	Mfg. No.	Description
EYE/FACE WASH		
SEB239	7260B-7270B	ABS Plastic Bowl
SEB240	7360B-7460B	Stainless Steel Bowl
ACCESSORIES		
SEB264	9102	Stainless Steel Dust Cover
SEI814	9201EW	Thermostatic Mixing Valve

EMERGENCY SHOWERS & FIRST AID

COMBINATION EMERGENCY SHOWER & EYE/FACE WASH STATION

- Hydrodynamic shower design
- Revolutionary inverted flow sweeps contaminants away from the vulnerable nasal cavity
- 11" diameter green ABS plastic bowl
- Galvanized stanchion for long life
- Mesh strainer collects debris
- Durable stainless steel ball valve
- Certified by CSA to meet ANSI standard Z358.1-2009



Model No.	Mfg. No.	Description
SEB257	8320-8325	Combination Shower
SEB264	9102	Dust cover

HALO™ COMBINATION SHOWER & EYEWASH STATIONS

- Combine Halo™ eyewash technology with SpinTec™ shower features for high performance safety installations
- SpinTec™ showers yield superior fluid distribution
- Durable ABS plastic showerhead and bowl
- Compact profile means less in-plant damage
- Features antimicrobial protection, integral strainers, and rugged safety-yellow powder coat paint
- Aquaduct™ self-draining design eliminates bacteria growth from standing fluid
- Eye/face wash models provides industry leading 85% facial coverage
- Optional see-through plastic dust cover (shown) makes inspection simple
- ULC certified to ANSI standard Z358.1-2009



Model No.	Mfg. No.	Dust Cover Included
EYEWASH		
SEB801	S193140A1AAAA00	No
SEB803	S193140A1AABA00	Yes
EYE/FACE WASH		
SEB806	S193140A1ABA00	No
SEB807	S193140A1ABBA00	Yes

OCCUPATIONAL HEALTH & SAFETY REGULATION FIRST AID KITS

Occupational first aid kits meet regulations required by federal, provincial and territorial jurisdictions.

For more information regarding federal and provincial first aid regulations, please visit the websites listed in the chart.

Regulations change on a continuing basis. Requirements vary from jurisdiction to jurisdiction and are dependent on a number of factors including (but not limited to):

- Maximum number of employees at the work site (or per shift)
- Location of the place of employment/industry
- Type of industry and potential hazards
- Proximity or travel time to a medical facility



Model No.	Refill No.	Container Type	Kit Type
FEDERAL - http://laws.justice.gc.ca/eng/SOR-86-304			
SAY106	SAY108	10-unit plastic	Type A, 2-5 workers
SAY109	SAY111	24-unit plastic	Type B, 6-19 workers
SAY113	SAY114	# 2 metal	Type C, 20-199 workers
BRITISH COLUMBIA - www.worksafecbc.com			
SAY117	SAY119	36-unit plastic	Basic
SAY121	SAY123	# 2 plastic	Level 1
SAY125	SAY127	# 2 plastic	Level 2
ALBERTA - www.gov.ab.ca			
SAY132	SAY134	16-unit plastic with gasket	No. 1
SAY135	SAY137	36-unit plastic with gasket	No. 2
SASKATCHEWAN - www.labour.gov.sk.ca			
SAY141	SAY143	24-unit plastic	1-9 workers
SAY144	SAY146	36-unit plastic	10-40 workers
MANITOBA - www.gov.mb.ca/labour			
SAY150	SAY152	24-unit plastic	25 workers

Model No.	Refill No.	Container Type	Kit Type
ONTARIO - www.labour.gov.on.ca/english/hs			
SAY153	SAY155	10-unit plastic	Sec. 8, 1-5 workers
SAY156	SAY158	36-unit plastic	Sec. 9, 6-15 workers
SAY159	SAY161	# 2 plastic	Sec. 10, 16-199 workers
SAY240	-	10-unit plastic	Truck Kit, 1-5 employees
SAY242	-	16-unit plastic with gasket	Contractor's Kit, 1-5 employees
QUEBEC - www.csst.qc.ca			
SAY174	SAY176	36-unit plastic	Sec. 4 (Standard)
SAY171	SAY173	10-unit plastic	Sec. 5 (Vehicle)
SEE531	-	10-unit plastic	Truck Kit
SEE534	-	# 6 metal	Workplace standard kit
NEW BRUNSWICK - www.worksafenb.ca			
SAY177	-	10-unit plastic	Personal
SAY179	SAY181	36-unit plastic	Standard

Model No.	Refill No.	Container Type	Kit Type
NOVA SCOTIA - www.gov.ns.ca			
SAY185	SAY187	16-unit plastic	No. 2, 2-19 workers
SAY188	SAY190	24-unit plastic	No. 3, 20-49 workers
PRINCE EDWARD ISLAND - www.wcb.pe.ca			
SAY197	SAY199	16-unit plastic	No. 2, 2-19 workers
SAY200	SAY202	24-unit plastic	No. 3, 20+ workers
NEWFOUNDLAND & LABRADOR - www.gov.nf.ca			
SAY207	SAY209	16-unit plastic	No. 2, 2-14 workers
SAY210	SAY212	24-unit plastic	No. 3, 15-199 workers
NORTHWEST TERRITORIES & NUNAVUT - www.gov.nt.ca			
SAY213	SAY215	24-unit plastic	No. 1
YUKON - www.wcb.yk.ca			
SAY224	SAY226	16-unit plastic	No. 1

COMPANIES WITH OVER 100 EMPLOYEES REQUIRE A FIRST AID ROOM

LOCKS & LOCKOUT DEVICES

RESETTABLE BRASS COMBINATION PADLOCKS

- Easy "Set-your-Own" 4-digit combination with up to 10 000 combinations available
- Strong, solid brass case construction resists corrosion - ideal for harsh environments
- Heavy hardened steel shackles provide high resistance to cutting and prying
- SEJ513 features a key override proving immediate access to supervisors in the field
- SEJ514 control key sold separately

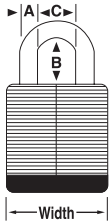

SAS366



SEJ513

Master Lock

Model No.	Mfg. No.	Body Width"	Shackle Clearance			Shipping Weight lbs.
			A"	B"	C"	
SAS366	175	2	5/16	1	1	0.60
SAG162	175LH	2	5/16	2 1/4	1	0.70
SEJ513	176	2	5/16	1	1	0.60
SEJ514	K176	Control Key				0.02

ECONOMY V-LINE BRASS PADLOCKS (NON-REKEYABLE)

- Solid brass body and cylinder construction resists corrosion - ideal for harsh environments
- Case hardened shackle resists sawing and filing
- Pin tumbler cylinder provides greater pick resistance
- Locks come with two keys
- For keyed alike options, please call us

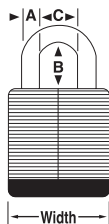

SAS395

Master Lock

Model No.	Mfg. No.	Key Type	Body Width"	Shackle Clearance			Shipping Weight lbs.
				A"	B"	C"	
SAS395	4120	Different	3/4	5/32	7/16	3/8	0.10
SAS396	4120KA	Alike	3/4	5/32	7/16	3/8	0.10
SAS397	4130	Different	1 1/8	3/16	9/16	9/16	0.20
SAS398	4130KA	Alike	1 1/8	3/16	9/16	9/16	0.20
SAS015	4140	Different	1 1/2	1/4	13/16	13/16	0.30
SAS400	4140KA	Alike	1 1/2	1/4	13/16	13/16	0.30
SAS401	4150	Different	1 7/8	9/32	15/16	1	0.40
SAS402	4150KA	Alike	1 7/8	9/32	15/16	1	0.40

PRO SERIES® WEATHER TOUGH™ SECURITY PADLOCKS (REKEYABLE)

- Constructed of hardened, chrome rustproofed steel laminated bodies that resist cutting, sawing and corrosion
- Durable thermal plastic covers protect the body of the lock from dirt, dust and other contaminants
- Hardened boron alloy steel shackles offers superior cut resistances while dual ball bearing locking mechanism resists pulling and prying attacks
- 5-pin Pro Series® cylinders provide tens of thousands of key changes
- Special spool pin tumblers are virtually impossible to pick
- Rekeyable - replaceable cylinder and shackle
- Locks come with two keys
- For keyed alike options and master keying, please call us

SA903



SAL433

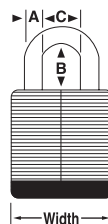

Model No.	Mfg. No.	Key Type	Body Width"	Shackle Clearance			Shipping Weight lbs.
				A"	B"	C"	
SAL433	6121	Different	2 1/8	5/16	1 1/8	7/8	1.00
SAL434	6121LJ	Different	2 1/8	5/16	2 1/2	7/8	1.05
SA902	6125	Different	2 3/8	3/8	1 3/8	7/8	1.20
SA903	6125KA	Alike	2 3/8	3/8	1 3/8	7/8	1.20

ZENEX™ THERMOPLASTIC SAFETY PADLOCKS

- Designed exclusively for lockout/tagout
- Durable, lightweight, non-conductive body
- Offers superior performance against chemicals, moisture, temperature and UV
- Reserved-for-safety cylinder provides over 40,000 unique key changes available
- Key retaining - ensures that padlocks are not left unlocked
- Includes write-on "Danger" and "Property of" labels in English, French and Spanish
- Locks come with one key: Compliance with OSHA "one employee, one lock, one key" directive
- For extra keys, keyed alike options or master keying, please call us

Master Lock



Model No.	Mfg. No.	Colour	Body Width"	Shackle Clearance			Weight lbs.
				Width"	Height"	Dia."	
SAL134	410BLK	Black	1 1/2	25/32	1 1/2	1/4	0.23
SAL135	410BLU	Blue	1 1/2	25/32	1 1/2	1/4	0.23
SAL136	410GRN	Green	1 1/2	25/32	1 1/2	1/4	0.23
SAL137	410ORJ	Orange	1 1/2	25/32	1 1/2	1/4	0.23
SAL138	410RED	Red	1 1/2	25/32	1 1/2	1/4	0.23
SAL139	410YLW	Yellow	1 1/2	25/32	1 1/2	1/4	0.23

ALUMINUM SAFETY LOCKOUT PADLOCKS

- Ideal for corrosive and tough environments
- Hardened shackles for superior resistance to cutting
- Steel shackle 1 9/16" wide solid body, 1/4" diameter x 1 1/16" long shackle
- 5-spool pin tumbler cylinder for added pick resistance
- Removable cylinder can be replaced or repinned
- Tens of thousands of key changes available
- Baked-on powder-coated finish stays bright
- Available in six colours, keyed different
- Laser engraving service available for an additional charge



Master Lock

Model No.	Mfg. No.	Colour	Model No.	Mfg. No.	Colour
SN709	6835RED	Red	SN712	6835YLW	Yellow
SN710	6835BLU	Blue	SN713	6835ORJ	Orange
SN711	6835GRN	Green	SN714	6835BLK	Black

LAMINATED PADLOCKS

- Each keyed different lock has a unique key for higher security
- Padlocks are made from rustproofed laminated steel
- SA886 and SA888 are economic protection best suited for tamper resistant applications
- SA890 and SA892 provide medium general security, use on tool boxes, man hole covers
- SA894 to SA900 are high security locks that provide a higher tamper resistant lock body and shackle.
- Use on tool cribs, storage cabinets and gates
- All models include two keys

Master Lock



SA890

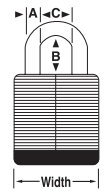

Model No.	Mfg. No.	Security Level	Locking Mechanism	Body Width"	Shackle Dimensions			Wt lbs.
					A"	B"	C"	
SA886	22	Medium	Warded	1 1/2	1/4	5/8	9/16	0.3
SA888	500	Medium	Warded	1 3/4	9/32	13/16	13/16	0.5
SA890	7	Medium	4-Pin Tumbler	1 1/8	3/16	9/16	1/2	0.2
SA892	7LJ	Medium	4-Pin Tumbler	1 1/8	3/16	2 1/2	1/2	0.2
SA894	3	High	4-Pin Tumbler	1 9/16	9/32	3/4	5/8	0.5
SA896	3LH	High	4-Pin Tumbler	1 9/16	9/32	2	5/8	0.5
SA898	1	High	4-Pin Tumbler	1 3/4	5/16	15/16	3/4	0.6
SA900	1LJ	High	4-Pin Tumbler	1 3/4	5/16	2 1/2	3/4	0.6

COMBINATION LOCKS

- World's best-selling combination lock
- Hardened steel shackle for extra cut resistance
- Combination security for keyless convenience
- 1 7/8" wide double-armored stainless steel body
- 3-digit dialing and 1500 combinations for maximum security
- Different combinations

Master Lock



Model No.	Mfg. No.	Shackle Dimensions		
		A"	B"	C"
SR914	1500	9/32	3/4	13/16
SAL506	1500LH	9/32	2	13/16

LOCKS & LOCKOUT DEVICES

LATCH TIGHT™ PORTABLE LOCK BOXES

- With new Latch Tight™ locking mechanism
- English, Spanish, French message on box
- Accepts 12 padlocks or lockout hasps



**Master
Lock**

Model No.	Mfg. No.	Colour
SAL519	498A	Red

LABELLED SNAP-ON HASPS

- Combines multiple-person lockout and tagout identification
- Features an easy-to-apply "snap-on" advantage with its spring-loaded locking arm
- Fits more lockout points than alternative rivet-hinge labeled lockout hasps
- Anodised aluminum and stainless steel construction for combined corrosion resistance and strength
- Up to five workers can apply their personal safety locks
- Complete with high-visibility permanent safety labels (English, French and Spanish) that can be written on to identify the responsible person and then erased for the next job

**Master
Lock**



Model No.	Mfg. No.	Colour
SAL541	427	Red
SAQ002	427YLW	Yellow

ROTATING GATE VALVE LOCKOUTS

- Unique, patent-pending outward rotation allows for easier installation in confined space applications
- Each size rotates into itself
- Each size nests within the next larger size
- Tough, lightweight, dielectric Zenex™ thermoplastic bodies withstand chemicals; perform effectively in extreme conditions (temperature range -50°F (-46°C) to 350°F (177°C))
- Up to four workers can apply their personal safety locks
- Red lockout colour identifies the safety lockout application
- Complete with high-visibility permanent safety labels (English, French and Spanish) that can be written on to identify the responsible person and then erased for the next job

SAL531



SAL528



**Master
Lock**

Model No.	Mfg. No.	Description
SAL526	480	Fits 1" to 3" Diameter Valve Handle
SAL527	481	Fits 2" to 5" Diameter Valve Handle
SAL528	482	Fits 4" to 6 1/2" Diameter Valve Handle
SAL529	483	Fits 6" to 10" Diameter Valve Handle
SAL530	484	Fits 8" to 13" Diameter Valve Handle
SAL531	485	1 Set Consists of 1 x SAL526, SAL527, SAL528, SAL529 & SAL530



SAL529

ADJUSTABLE CABLE LOCKOUTS

- Infinitely adjustable for a secure fit every time
- Integrated, single-piece safety hasp and cable for ease-of-use
- Ideal for both multiple circuit breaker panel and side-by-side gate valve lockouts
- Tough, lightweight, Zenex™ thermoplastic body withstands chemicals; performs effectively in extreme conditions
- Up to four workers can apply their personal safety locks
- Red lockout colour identifies the safety lockout application
- Complete with high-visibility permanent safety labels (English, French and Spanish) that can be written on to identify the responsible person and then erased for the next job
- Custom cable lengths available

**Master
Lock**



Model No.	Mfg. No.	Description
SED596	S806CBL3	Cable Lockout w/3' Cable
SED597	S806	Cable Lockout w/6' Cable
SED598	S806BL15	Cable Lockout w/15' Cable

LOCKOUT STATIONS

VIRTUALLY INDESTRUCTIBLE,
THE STRONGEST STATIONS AVAILABLE!

- Integrated, 1-piece molded construction eliminates loose parts
- Resilient polycarbonate material provides twice the heat resistance and quadruples the impact strength of typical stations
- Reinforced snap-lock clips provide easy padlock and hasp storage and removal
- Exclusive translucent lockable cover protects contents and prevents loss of valuable safety lockout padlocks
- Zenex™ locks available with up to 100 000 key changes available to fit even the largest lockout systems
- Lockout stations are bilingual with English/French labels and lockout tags
- Compliant with OSHA "One employee, One lock, One key" directive

**Master
Lock**

4-LOCK STATION INCLUDES:

- Four Master Lock® Safety Series™ Padlocks
- Two Safety Series™ hasps for lockouts by up to six workers
- 12 Safety Series™ heavy-duty bilingual Do Not Operate lockout I.D. tags with brass grommets
- Dimensions: 12 1/4" x 16" x 1 3/4"



SAO601

Model No.	Mfg. No.	Description
SA0598	1482BFRC	Base only
SA0601	1482BP3FRC	Station with Laminated Padlocks
SA0602	1482BP410FRC	Station with Zenex™ Padlocks
SA0603	1482BP1106FRC	Station with American Lock® Aluminum Padlocks

SAFETY LOCKOUT HASPS

- Keeps equipment inoperative while repairs or adjustments are made
- Attach device to energy disconnect switch
- Control cannot be turned on until last worker's padlock is removed
- Up to six workers at each lockout point
- Heavy gauge steel jaws resist prying against unauthorised access
- Lockout hasp has vinyl coated handles and is plated to resist rust
- Compatible with nos. 3, 410, 411, 6835 and 6836 safety lockout padlocks with shackle diameters as large as 3/8"



**Master
Lock**

RED W/O LOCKING TABS

Model No.	Mfg. No.	Inside Jaw Clearance"
SA875	420	1
SA876	421	1 1/2

YELLOW (ECONOMY) W/LOCKING TABS

Model No.	Mfg. No.	Inside Jaw Clearance"
SAN507	422	1
SAN508	424	1 1/2

ROTATING ELECTRICAL PLUG LOCKOUTS

- Outward/inward rotation allows for easier installation and storage
- Surrounds the electrical plug; protects against accidental reconnection
- Each size rotates into itself to fit effectively into safety tool boxes
- Tough, lightweight, dielectric Zenex™ thermoplastic bodies withstand chemicals; perform effectively in extreme conditions (temperature range -50°F (-46°C) to 350°F (177°C))
- Red lockout colour identifies the safety lockout application
- Complete with high-visibility permanent safety labels (English, French and Spanish)
- SAL521 labels can be written on to identify the responsible person and then erased for the next job

**Master
Lock**



SAL520

Padlock not included

SAL521



Model No.	Mfg. No.	For Electrical Plugs Up To
SAL520	487	2 1/4" Dia. x 3 1/4" w/Cord Dia. up to 3/4" (Most 110- and Many 220-Volt Plugs)
SAL521	488	3" Dia. x 6" w/Cord Dia. up to 3/4" (Most 220- and 550-Volt Plugs)

MIRRORS

DOMESTIC MIRRORS

- Increase surveillance and prevent accidents due to blind corners
- Constructed of acrylic for added durability
- All mirrors have a black protective edge and hanging clips
- Full dome mirrors come with hanging chains and hooks
- All mirrors are open-topped

Ideal Locations:

- 360° 4-way intersections
- 180° T-intersections
- 90° Corner intersections

Model No.	Mirror Dia.,"
FULL DOME - 360°	
SEJ875	20
SEJ876	24
SEJ877	31
SEJ878	47
HALF DOME - 180°	
SEJ879	20
SEJ880	24
SEJ881	31
SEJ882	47
QUARTER DOME - 90°	
SEJ883	20
SEJ884	24

USE FURNITURE POLISH TO CLEAN MIRRORS. GLASS CLEANER WILL DAMAGE SURFACE.

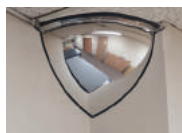
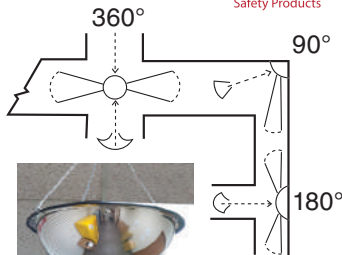

ROUNDTANGULAR CONVEX MIRRORS

- Designed to fit into smaller spaces
- Grants the same view as a full sized convex mirror but occupies a smaller area
- Ideal for blind spots near machinery and areas where mounting space is limited
- Comes with adjustable arm

USE FURNITURE POLISH TO CLEAN MIRRORS. GLASS CLEANER WILL DAMAGE SURFACE.



	INDOOR	OUTDOOR
Mirror Dia.,"	Model No.	Model No.
12 x 18	SDP532	SDP528
18 x 26	SDP533	SDP529
20 x 30	SDP534	SDP530
24 x 36	SDP535	SDP531

CONVEX MIRRORS

- Removes blind spots reducing the chance of accidents caused by blind corners
- Includes adjustable arm
- Adjustable ball and swivel mount with 100° viewing angle

USE FURNITURE POLISH TO CLEAN MIRRORS. GLASS CLEANER WILL DAMAGE SURFACE.



	INDOOR	OUTDOOR
Mirror Dia.,"	Model No.	Model No.
12	SDP505	SDP500
18	SDP506	SDP501
26	SDP507	SDP502
30	SDP508	SDP503
36	SDP509	SDP504

INSPECTION MIRROR

- Ideal for viewing hard to see areas such as around corners or under vehicles and equipment
- 1" Swivel wheel allows for effortless maneuverability
- Lightweight design
- Handle Length: 47"
- Mirror Shape: Round
- Mirror Size: 8.5" dia.

Model No. SFQ773



CLOSED-TOP DOME MIRRORS

- Removes blind spots reducing the chance of accidents caused by blind corners
- Durable heavy-duty acrylic construction

USE FURNITURE POLISH TO CLEAN MIRRORS. GLASS CLEANER WILL DAMAGE SURFACE.



FULL DOME - 360°		HALF DOME - 180°	
Model No.	Mirror Dia.,"	Model No.	Mirror Dia.,"*
SDP520	18	SDP524	18
SDP521	26	SDP525	26
SDP522	32	SDP526	32
SDP523	48	SDP527	48

* The dimensions listed are that of a full dome



DROP-IN CEILING PANEL DOMES

- One-piece drop-in dome replaces a standard 2' x 2' drop-ceiling tile
- Dome provides 360° viewing for optimal surveillance
- Ideal for 4-way intersections
- Diameter: 24"

Model No. SDP536

USE FURNITURE POLISH TO CLEAN MIRRORS. GLASS CLEANER WILL DAMAGE SURFACE.



SAFETY TAPES & PAINTS

ANTI-SKID TAPE

- Helps prevent injuries from slipping and falling
- Grit sandpaper surface with adhesive backing
- Water, grease, and oil resistant
- Ideal for both indoor and outdoor applications
- Meets or exceeds NFSI 101-A and OSHA 1910.24 and 1910.26
- RoHS compliant
- Length: 60'



Model No.	Width"	Colour
SDN088	2	Red/White
SDN089	2	Black/Yellow
SDN090	2	Yellow
SDN091	2	Red
SDN098	1	Black
SDN099	2	Black
SDN100	4	Black
SDN101	6	Black
SDN102	12	Black
SDN103	1	Clear
SDN104	2	Clear
SDN105	4	Clear
SDN106	6	Clear

TRACTION CLEAT

- Helps prevent injuries from slipping and falling
- Grit sandpaper surface with adhesive backing
- Water, grease, and oil resistant
- Ideal for both indoor and outdoor applications
- Pre-cut sizes with rounded corners offer a finished look and prevents the corners from lifting
- Meets or exceeds NFSI 101-A and OSHA 1910.24 and 1910.26
- RoHS compliant



Model No.	Dimensions W" x L"	Description	Qty /Pack
SDN107	3/4 x 24	Rounded Edge Strip	50
SDN108	3 x 24	Strip	50
SDN109	6 x 24	Strip	50
SDN110	6 x 30	Strip	50
SDN111	5 1/2 x 5 1/2	Square	50
SDN112	6 x 24	Strip w/Reflective Band	10
SDS936	6 x 24	Black/Yellow Strip	1

BARRICADE TAPE

- Warn against hazards by restricting entry to dangerous areas
- Ideal for both indoor and temporary outdoor usage
- Made of polyethylene



Model No.	Message	Colour	Roll Size
STANDARD DUTY - 1.5 MIL			
SEK397	Caution	Black on Yellow	3" x 1000'
SFJ602	Caution	Black on Yellow	3" x 300'
SEK398	Attention	Black on Yellow	3" x 1000'
SEK399	Danger	Black on Red	3" x 1000'
SDS739	Danger	Black on Yellow	3" x 1000'
HEAVY-DUTY - 2.0 MIL			
SEK400	Caution	Black on Yellow	3" x 1000'
SEK401	Attention	Black on Yellow	3" x 1000'
SEK402	Danger	Black on Red	3" x 1000'
EXTRA HEAVY-DUTY - 2.5 MIL			
SEK403	Caution	Black on Yellow	3" x 1000'
SEK404	Attention	Black on Yellow	3" x 1000'
SEK405	Danger	Black on Red	3" x 1000'
SDS740	Danger	Black on Yellow	3" x 1000'

LINE-UP® STRIPING PAINT

- 20 oz. cans (18 oz. net weight)
- Available in non-burning water based formula for grass fields, solvent based formulas for pavement and removable formulas for synthetic turf surfaces that require quick change

Model No.	Description	Colour
WATER BASED - ATHLETIC FIELD		
NE333	White	
NE334	Yellow	
NI795	Turf Green	
SOLVENT BASED - PAVEMENT		
NE335	Highway White	
NE336	Highway Yellow	
NE337	Handicap Blue	
NE338	Firelane Red	
NE339	Cover-up Black	



Actual paint colours may vary

STRIPING MACHINES

- Engineered and designed for easy operation and durability
- 18-gauge all-steel construction
- 12-can storage
- Stripes widths of 2" to 4"

PAVEMENT STRIPING MACHINES

- 7" wheels provide a smooth ride on hard surfaces, such as concrete, blacktop and metal
- Excellent for use in parking lots, warehouses, plants, factories, etc.

Model No. NE340



NE340



ATHLETIC FIELD STRIPING MACHINES

- 10" wheels elevate the carriage to provide an even ride over rough or uneven surfaces
- Ideal for grass, dirt, gravel or any uneven surface

Model No. NE341

QUICK-MARK™ MARKING PAINTS

Inverted marking paints are VOC-compliant, lead-free and highly pigmented. Available in water and solvent based, 20-oz. cans (17 oz. net weight). Can be used with hand held wands.



Model No.	Solvent Base	Colour	Model No.	Water Base	Colour
NC320	Fl. Red/Orange		NC331	White	
NC321	Fl. Orange		NC332	Utility Yellow	
NC322	Fl. Safety Red		NC333	Fl. Orange	
NC323	Fl. Green		NC334	Fl. Red	
NC324	White		NC335	Fl. Safety Pink	
NC325	High Vis. Yellow		NC336	Fl. Blue	
NC326	Caution Blue		NC337	Fl. Safety Green	
NC327	Warning Orange		NC338	Fl. Red/Orange	
NC328	Safety Red				
NC329	Safety Green				

Actual paint colours may vary

MARKING WANDS

- Constructed of durable, rugged plastic and lightweight steel
- Comfortable pistol grip for easy handling and marking
- Apply a uniform 1" to 1 1/2" wide stripe of paint



Model No.	Description
NC309	Spotter Hand Held Wand 12"
NC310	Hand Held Wand 34"

CROWD & TRAFFIC CONTROL

TRAFFIC CONES

- 100% PVC construction offers excellent flexibility and durability
- Temperature resistance in hot and cold environments
- Fluorescent orange color provides high visibility
- Available with 6" and 4" reflective collars
- High-density interlocking base offers maximum stability
- Meets Minister of Transport regulations for Québec, Ontario and Alberta



SEF026



Model No.	Height"	Collar	Wt. lbs.
SEF026	18	6" (QC, ON, AB)	3.15
SEF027	28	4" (ON, AB)	6.75
SEF028	28	6" and 4" (QC, ON, AB)	6.75

PREMIUM TRAFFIC CONES

- 100% PVC construction offers maximum flexibility and durability
- Superior temperature resistance in hot and cold environments
- Fluorescent orange colour provides high visibility
- Available with 6" and 4" 3M™ high intensity collars
- High density interlocking base offers maximum stability
- Meets Ministry of Transport regulations for Quebec, Ontario and Alberta

SEB772



Model No.	Description	Wt. lbs.
TRAFFIC CONES		
SEB768	12"	2
SEB769	18"	3.3
SEB771	28"	7
TRAFFIC CONES W/COLLAR		
SEB770	18" w/6" Collar (QC, ON, AB)	3.3
SEB772	28" w/6" and 4" Collars (QC, ON, AB)	7
SEB826	28" w/4" Collar (ON, AB)	7



PREMIUM DELINEATOR POSTS

- Standard 42" high post with indentations for easier grip
- 100% LDPE construction offers maximum flexibility and durability
- Superior temperature resistance in hot and cold environments
- Fluorescent orange colour provides high visibility
- Two pre-applied 4" 3M™ high intensity reflective tape collars
- High density interlocking 16" x 16" base offers maximum stability and durability



SEC153



Model No.	Description	Wt. lbs.
SEB773	Delineator Post Only	1.8
SEB774	Rubber Base	10
SEC153	Post and Base Kit	12

PORTABLE INTERLOCKING BARRIERS

- Ideal for directing people in areas where crowd control is required
- Rugged welded steel construction
- Feet are removable so railing will lay flat for shipping and storage
- Includes connectors to attach multiple units together
- Overall dimensions: 102" L x 40" H
- Distance between vertical bars: 7"
- Rail diameter: 1 5/8"
- Weight: 56 lbs.



SEE395



SEE396



SPEED BUMPS

- 1-piece lightweight 100% recycled rubber
- Resistant to corrosion, moisture, oil, weather variations and UV light
- Perfect for speed reduction in parking lots, school zones and areas with heavy pedestrian traffic
- Black with bright yellow reflective stripes for maximum visibility
- Easily installed with 14" rebar spike for permanent or temporary installation
- 11" W x 2" H

Model No.	Description	Length	Spikes Required	Weight lbs.
SEH142	Speed Bump	4'	5	35
SEH143	Speed Bump	6'	4	55
SEH144	Rebar Spike	14"	-	-

SEH142



SEH144



FREE-STANDING CROWD CONTROL BARRIERS

- 4-way connection permits all posts to receive up to three tapes from any direction
- Slow retracting tape cassette insures tape will retract safely
- Specially designed locking mechanism prevents accidental release
- Receiver post without tape cassette for use at the end of a line of posts
- Height: 35" • Tape length: 7' • Recommended post spacing: 6'6"

STANDARD FREE-STANDING BARRIERS



Photo consists of
1 x SAS226 &
1 x SAS230

Model No.	Description	Tape Colour	Tape Length'
SAS226	Stainless Steel Post with Cassette	Red	7
SAS227	Black Post with Cassette	Black	7
SAS230	Stainless Steel Receiver Post	-	-
SAS231	Black Receiver Post	-	-



Locking Mechanism prevents accidental release!



SAFETY FREE-STANDING BARRIERS

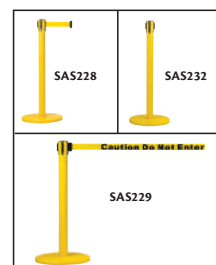

Photo consists of
1 x SAS228 &
1 x SAS232

Model No.	Description	Tape Colour	Tape Length'
SAS228	Yellow Post with Cassette	Yellow	7
SAS229	Yellow Post with Cassette	Yellow (Caution Do Not Enter)	7
SEE818	Yellow Post with Cassette	Yellow (Attention Ne Pas Entrer)	7
SAS232	Yellow Receiver Post	-	-

WAREHOUSE MONITORING INSTRUMENTS

HEAT STRESS METER/DATA LOGGER

- Measures indoor and outdoor WBGT (Wet Bulb Globe Temperature), Black Globe (TG) temperature, humidity, wet bulb, dew point and air temperatures
- Adjustable audible WBGT alarm setting
- Real time data logger with integral 2GB SD memory card (optional)
- RS232 and USB interface
- Temperature is measured in °C or °F

SPECIFICATIONS

Indoor WBGT Range: 0° to 59 °C
Outdoor WBGT Range: 0° to 56 °C
TG Temp. Range: 0° to 80 °C
Air Temp. Range: 0° to 50 °C
Humidity Range: 5 % to 95 % RH

Model No. IA794 Mfg. No. SD-2010

REED



REED SOUND LEVEL METER/DATA LOGGERS

- Measuring Range: Low: 30 to 90 dB; Med: 50 to 110 dB; High: 70 to 130 dB Auto: 30 to 130 dB
- Dynamic Range: 60 dB • Accuracy: ±1.4 dB
- Resolution: 0.1 dB
- Sample Rate: Digital: 0.5 sec. Analog: 50 ms
- Frequency Range: 20 Hz to 8 kHz
- Frequency Weighting: A and C
- Microphone: 1/2" electret condenser
- Power Supply: 4 x AAA batteries
- Meets IEC 61672-1 Class 2 requirements
- Records up to 64 000 datapoints (1 MB)
- 60 dB dynamic space in each range • Real time clock and calendar
- Fast/slow time weighting • Min/Max function • USB Interface
- Analog digital bar graph • Backlit LCD display
- Tripod mount design for long-term monitoring
- Includes windscreen, USB cable, Windows software, batteries and hard carrying case

REED



Model No.	Mfg. No.	Description
IB749	R8080	Sound Level Meter/Data Logger

TACHOMETERS

- Dual function unit with both contact and non-contact capabilities
- Supplied with adapters for fpm, rpm and surface speed measurements
- Non-contact function utilizes laser light beam for improved accuracy
- Recalls Max/Min and last values
- Large, easy-to-read display
- Autoranging with 0.05 % accuracy
- Includes battery and carrying case
- Measuring Range: Photo: 5 to 99,999 rpm; Contact: 5 to 19,999 rpm; Surface Speed: 0.05 to 1999 mpm

REED



HX386

Model No.	Mfg. No.	Description
HX386	R7100	Photo/Contact Tachometer
IA046	ST-CONE	Replacement Contact Adapter
IA047	ST-WHEEL	Replacement Surface Speed Wheel
IA740	ST-FUNNEL	Replacement Funnel Tip
IA741	ST-SHAFT	Replacement Extension Shaft

INFRARED THERMOMETERS

- Pocket-sized and easy-to-use - just point, shoot and read
- Unique flat surface and modern housing design
- User selectable °F or °C
- Built in laser pointer identifies target area
- Backlighting illuminates display for taking measurements at night or in areas with low background light levels
- Overrange indicator, auto data hold (when trigger released) and auto shut off
- Fixed 0.95 emissivity covers 90 % of surface applications
- 8:1 Distance to Spot size ratio
- Includes: battery and carrying case
- Temperature range: -58 ° to 932 °F (-50 ° to 500 °C)
- Accredited calibration available



IB537

REED

Model No.	Mfg. No.	Description
IB537	R2002	Infrared Thermometer

LIGHT METERS

- Designed for one-hand operation and to fit easily into a tool belt or pocket
- Autoranging
- Data Hold and Min/Max functions
- Auto shut-off and zero adjust button
- Over range and low battery indications
- Ranges: 0 to 20 000 lux; 0 to 2000 ftc
- User selectable Lux/Ftc
- Includes battery



REED

Model No.	Mfg. No.	Description
HX288	LM-81LX	Light Meter

INDOOR/OUTDOOR WIRELESS HUMIDEX THERMOMETERS

- Displays humidex and heat index
- Humidex and heat index is a combination of temperature and humidity into one number to reflect perceived temperature
- Heat stress index scale
- Indoor and outdoor temperature
- Outdoor humidity
- Min/max memory
- °C and °F switchable
- Wireless transmission range: 45 m/150'



IA504

BIOS
Weather

Model No.	Mfg. No.	Description
IA504	260BC	Wireless Humidex Thermometer

INDEX

- A**
- Absorbents 219
 - Acrylic Coating 195
 - Acrylic Paint 195
 - Adhesives, Spray 157
 - Air Products**
 - Hose Reels 192
 - Piping 116
 - Aircraft Cables 35
 - Aisle Signs 119
 - Alkyd Paint 195
 - Anchors**
 - Screw Pin 38
 - Snap Hook 35
 - Angled Brooms 174
 - Antibacterial Soap 176
 - Anti-Fatigue Matting 207-211
 - Anti-Skid Cleats 243
 - Anti-Skid Tape 243
 - Anti-Static Matting 212
 - Appliance Trucks 2-3
 - Aprons 235
 - Archive, Shelving 117
 - Arm/Leg Bands,
 - Traffic Control 237
 - Ashtrays 60, 183-184
- B**
- Bag Sealing Tape 159
 - Bags**
 - Garbage 167
 - Poly 154, 158
 - Tool 81-82
 - Banding Film 154
 - Bands, Hearing 228
 - Bankers® Boxes 203
 - Bar Racks 109
 - Barricade Tape 243
 - Barricades, Traffic Control 244
 - Bars, Cargo 47
 - Batteries 190
 - Beam Clamps 34
 - Beam Trolleys 34
 - Belts, Tool 81
 - Bench Cans 194
 - Bench Scales 164-165
 - Bench Vises 192
 - Benches**
 - Locker Room 105
 - Service 85-86
 - Work 86-92
 - Bin Carts 140
 - Bin Racks 92, 140-141, 148
 - Bin Shelves 131, 141
 - Bin Support Panels 140
 - Bins**
 - Mobile 131
 - Nesting 133, 135, 137
 - Revolving 149
 - Shelf 132-133
 - Small Parts 141, 148
 - Stacking 129-134, 137, 140, 151
 - Steel 151, 153
 - Blades, Packaging Knife 159
 - Blankets, Moving 51
 - Blowers, Portable 180
 - Bollards 45-46
 - Bolts**
 - Carriage 45, 113
 - Eye 35
 - Bonding & Grounding Wires 55
 - Booms, Jib 33
 - Boot, Decontamination 212
 - Boot Sanitizer 212
 - Box Sealing Tape 156
 - Box Sealing Tape Dispensers 156
 - Box Trucks 16, 18-19
 - Boxes**
 - Corrugated Paper 155
 - Filing 203
 - Jobsite 78-79, 83, 147
 - Tool Storage 82-83
 - Tote 129
 - Broadcast Spreaders 182
 - Brooms 174
 - Bubble Mailers 154
 - Buckets 171-172
 - Buckles 161
 - Bumpers, Dock 49
 - Bung Socket, Drum 61
 - Bung Wrenches 61
- C**
- Cabinet Drawers 150
 - Cabinets**
 - Acid/Corrosives 213, 215
 - Computer 200
 - Drum 215
 - Filing 202
 - Flammables 213-215
 - Gas Cylinder 215
 - Key 202
 - Paint and Ink 213-214
 - Small Parts 143-146, 149-150, 152
 - Storage 96-102, 142
 - Tool Storage 84
 - Cable Lockouts 241
 - Cable Protectors, Dock 43
 - Cable Ties 155
 - Cables, Aircraft 35
 - Caddy, Waste Container 168
 - Cafeteria Supplies**
 - Coolers 205
 - Tables 203
 - Cans**
 - Bench 194
 - Garbage 167-170
 - Oil 193
 - Oily Waste 216
 - Plunger 194
 - Safety 216
 - Cantilever Racks 109
 - Cap Seal Crimpers 61
 - Cargo Bars 47
 - Carriage Bolts 45, 113
 - Carton Staplers 155
 - Cartridges, Respirator 226
 - Carts**
 - Bin 140
 - Drywall 15
 - Janitorial 172
 - Ladder 73
 - Lumber 15
 - Mail 201
 - Order Picking 13
 - Parts Storage 146
 - Shelf 11-14, 128
 - Shop 11-14, 16, 128, 140, 146
 - Stock Picking 14
 - Tool 83-85, 92
 - Trades 11
 - Utility 11-12, 16, 128
 - Cases, Small Parts 147
 - Casters 17, 21-23, 196
 - Ceiling Fans 186
 - Ceiling Mounted Heaters 187
 - Chain, General Purpose 38
 - Chairs 196, 198-199
 - Changing Tables 175
 - Checklist Kit, Forklift 27
 - Chemical Resistant Clothing,
 - Aprons 235
 - Chemical Resistant Gloves 234
 - Chests, Tool Storage 78-80, 83-84
 - Chocks, Wheel 41-42
 - Circular Saws, Framing 243
 - Clamps 34, 64, 202
 - Clean Room Matting 212
 - Cleaners 173, 176
 - Cleaning Equipment**
 - Brooms 174
 - Buckets 171
 - Buckets/Wringers 171-172
 - Carts 172
 - Dustpans 174
 - Mops 172
 - Pressure Washers 182
 - Sweepers 179
 - Trigger Sprayers 173
 - Vacuum Cleaners 177-180
 - Wringers 171
 - Cleaning Fluids,
 - Parts Washers 194
 - Cleats 243
 - Clevis Grab Hooks 39
 - Clocks 204
 - Closures, Drum 52-53
 - Clothing 235-237
 - Coated Gloves 230-234
 - Collapsible Containers 153
 - Column Protectors 46
 - Compounds, Sweeping 174
 - Computer Cabinets 200
 - Computer Supplies**
 - Heel Grounders 212
 - iPad Holder 200
 - Cones, Traffic Control 244
 - Connectors, Straight Blade 188
 - Containers**
 - Collapsible 153
 - Distribution 135-136, 138-139
 - Food Handling 137
 - Mobile Bins 131
 - Nesting Bins 133, 135, 137
 - Poly 52
 - Recycling 166-167
 - Revolving Bins 149
 - Salt & Sand 181
 - Shelf Bins 132-133
 - Small Parts Bins 141, 148
 - Stacking Bins 129-134, 137, 140, 151
 - Steel Bins 151, 153
 - Tanks 137
 - Transfer Boxes 135
 - Convex Mirrors 242
 - Coolers, Containers 205
 - Cord Reels 191
 - Cords, Extension 188-189
 - Corkboards 203
 - Corn Brooms 174
 - Corner Protectors 44, 46, 161
 - Corrugated Boxes 155
 - Counting Scales 163
 - Coupling Link 39
 - Coveralls, General Protection 236
 - Covers**
 - Drum 53, 60
 - Waist Container 166-169
 - Shoe 235
 - Crane Scales 164
 - Cranes 32-33
 - Crimpers, Cap Seal 61
 - Crowd Control, Rope & Posts 244
 - Cups, Measuring 193
 - Curtains, Strip 114-115
 - Cut Resistant Gloves 233
 - Degreasers 173
 - Deheaders, Drum 61
 - Delineators, Traffic Control 244
 - Desks**
 - Computer Sit-Stand 200
 - Shop 95
 - Dial Scales 164-165
 - Diaphragm Pumps 56
 - Disinfectants 173
 - Dispensers**
 - Box Sealing Tape 156
 - Ear Plug 228
 - Filament Tape 156
 - Hand Sanitizer 176
 - Hand Soap 176
 - Strapping 160
 - Stretch Wrap 154
 - Two-Way Tape 156
 - Displays, Literature 201
 - Disposable Dust Masks 227
 - Disposable Gloves 234
 - Disposable Respirators 226-227
 - Distribution Containers 135-136, 138-139
 - Dock Equipment**
 - Bumpers 49
 - Cable & Hose Protectors 43
 - Dock Risers 48
 - Dockboards 48
 - Dockplates 6, 48
 - Fenders 49
 - Lights 50
 - Pallet Pullers 27, 47
 - Wheel Chocks 41-42
 - Dock Lights 50
 - Dollies**
 - Cabinet 102
 - Drum 63, 168, 220-221
 - Pail 63
 - Polyethylene 17, 139
 - Stacking 136
 - Steel Deck 102
 - Waste Container 166, 168
 - Wood 17
 - Dome Mirrors 242
 - Doors, Curtain 114-115
 - Double Sided Tape 156
 - Double Stepladders 69-72
 - Drain Seals 219
 - Drawers, Cabinet 150
 - Drum Bung Socket 61
 - Drum Equipment**
 - Bonding & Grounding Wires 55
 - Bung Socket 61
 - Cabinets 215
 - Closures 52-53
 - Covers 53, 60
 - Deheaders 61
 - Dollies 63, 168, 220-221
 - Drum Tumblers 67
 - Faucets 59
 - Funnels 60
 - Gauges 59
 - Handlers 67
 - Heaters 54
 - Lifters 64-66
 - Liners 53
 - Pail Heaters 54
 - Pail Inserts 53
 - Pail Tipplers 67
 - Pails 137
 - Pallet Servers 66
 - Pumps 56-58
 - Racks 67, 221
 - Rockers 63
 - Rotators 63
 - Spill Pallets 221-222
 - Spotters, Strip 62
 - Strainers 53
 - Tilters 57, 63
 - Trays 60
 - Trucks 62-63
 - Upenders 61
 - Valves 59
 - Vents 59
 - Drum Fans 185-186
 - Drum Tools 61
 - Drum Tumblers 67
 - Drums 52
 - Drywall Carts 15
 - Duct Tape 157
 - Dump Trucks 20
 - Dust Masks, Disposable 227
 - Dustpans 174

E

 - Ear Muffs 228
 - Ear Plugs 228
 - Earloop Face Mask 227
 - Edge Protectors 44, 46, 161
 - Electrical Plug Lockouts 241
 - Electrical Supplies**
 - Batteries 190
 - Connectors 188
 - Cord Reels 191
 - Extension Cords 188-189
 - Tape 157
 - Emergency Showers 239
 - Entrance Matting 206-207
 - Envelopes, Packing List 155
 - Ergonomic Products**
 - Gloves 231
 - Seating 198
 - Exhaust Fans 186
 - Expandable Gates 172
 - Extension Cords 188-189
 - Extension Ladders 70-73
 - Extension Poles 174
 - Extensions, Forklift 27, 65
 - Extinguishers, Fire 216
 - Eye Bolts 35
 - Eyewash Stations 238
 - Eyewear 224-225

F

 - Face Mask 227
 - Faceshields 223
 - Fall Protection 74, 229
 - Fan Forced Heaters 187
 - Fans 184-186
 - Fasteners**
 - Carriage Bolts 45, 113
 - Eye Bolts 35
 - Hex Nuts 45, 113
 - Hook & Loop 162
 - Screw Pin Anchors 38
 - Snap Hook Anchors 35
 - Faucets, Drum 59
 - Fenders, Dock 49
 - Filament Tape 156
 - Filament Tape Dispensers 156
 - Filing Boxes 203
 - Filing Cabinets, Vertical 202
 - Filters**
 - Respirator 226
 - Water 205
 - Fire Protection, Extinguishers 216
 - First Aid
 - Fitters' Gloves 230
 - Flame Resistant Clothing,
 - Rainwear 235
 - Flashlights 189-190
 - Flat Fold Respirator 227
 - Floodlights 191
 - Floor Cleaners 173
 - Floor Fans 185
 - Floor Scales 165
 - Floor Signs 172
 - Fluorescent Lamps/Light Bulbs 189
 - Folding Chairs 199
 - Folding Gates 46
 - Folding Tables 92, 203
 - Food Handling Containers 137
 - Footwear, Covers 235
 - Forklift Attachments**
 - Drum Lifters 65-66
 - Extensions 27, 65
 - Maintenance Platforms 74
 - Forklift Checklist Kit 27
 - Fountains, Water 205
 - Framing Saws 243
 - Funnels 60, 193
 - Furniture Pads 51

G

 - Gantry Cranes 32
 - Garbage Bags 167
 - Garbage Cans 167-170

- Garden Hose Hangers 182
 Garden Hoses 182
Gas Cylinder
 Cabinets 215
 Lockouts 104
 Gate Valve Lockouts 241
 Gate Valves 59
Gates
 Expandable 172
 Folding 46
 Gauges, Drum 59
 General Protection Clothing,
 Coveralls 236
 Glasses, Safety 224-225
 Gloves 230-234
 Glow in the Dark Tape 243
 Goggles, Safety 224-225
 Grease Guns 193
 Grinders, Heel 212
 Grounds Maintenance
 181-182
 Guard Rails 44-45
 Guards, Perimeter
 44-45, 108, 112
Guns
 Garden Hose 182
 Grease 193
H
 H.I.D. Lamps/Light Bulbs 189
 Hair Nets 235
 Half Mask Respirators 226
 Halogen Lamps/Light Bulbs
 50, 191
 Hammer Tackers 155
 Hand Cleaners 173, 176
 Hand Lamps 191
 Hand Pumps 56-58
 Hand Sanitizer Dispensers
 176
 Hand Sanitizers 176
Hand Tools
 Hex Keys 116
 Knives 159
 Vises 192
 Hand Towels 175
 Hand Trucks 1-6, 82
 Handlers, Drum 67
 Hangers, Garden Hose 182
 Hanging Scales 164
 Hard Hats 223
Harnesses
 General 74, 229
 Traffic Control 237
 Hasp Lockouts 241
 Hats, Hard 223
 Hazardous Materials Cabinets
 213-215
 Headlights, Hard Hat 189
 Hearing Bands 228
 Heat Stress Meter 245
 Heaters 54, 187
 Heel Grinders 212
 Hex Keys 116
 Hex Nuts 45, 113
 High Heat Coating 195
 High Heat Paint 195
 High Visibility Clothing 237
 Hoists 34, 40
 Holders, Tool Storage 81
 Hook & Loop Fasteners 162
 Hooks 39, 64
 Hoppers, Self-Dumping 21
 Horizontal Sheet Rack 109
 Hose Protectors, Dock 43
 Hose Reels 192
 Hoses, Garden 182
 HVAC 184-187
I
 Ice Salt 181
Identification
 Label Holders 119, 129
 Label Makers 119, 129
 Paint Markers 158
 Paint Sticks 158
 Signs 41, 119, 172
 Tags 119
 Illuminometers, Digital 245
 Industrial Cleaners 173
 Infrared Thermometers 245
 Inserts, Pail 53
Instruments
 Heat Stress Meter 245
 Illuminometers 245
 Infrared Thermometers 245
 Light Meters 245
 Load Indicators 40, 164
 Scales 163-165
 Sound Level Meters 245
 Tachometers 245
 Thermometer/Hygrometers
 245
 Time Clocks 204
 Wall Clocks 204
 iPad Holder 200
J
 Jacks, Trailer 47
Janitorial Products
 Brooms 174
 Buckets 171
 Buckets/Wringers 171-172
 Carts 172
 Dustpans 174
 Extension Poles 174
 Funnels 193
 Hand Towels 175
 Liquid Measures 193
 Measuring Cups 193
 Mops 172
 Pressure Washers 182
 Scoops 181, 193
 Sweepers 179
 Trigger Sprayers 173
 Vacuum Cleaners 177-180
 Waste Management
 60, 166-170, 183-184
 Wipes 172, 175
 Wringers 171
 Jib Booms 33
 Jib Cranes 33
 Jiggers 1, 24-26, 29
 Jobsite Boxes 78-79, 83, 147
K
 Kee Klamp® Pipe Fittings 116
 Kee Klamp® Piping 116
 Key Cabinets 202
 Key Tags 202
 Keys, Hex 116
Kitchen Supplies
 Coolers 205
 Tables 203
Kits
 First Aid 239
 Lockout 241
 Spill Control 217
 Knit Gloves 231
 Knives 159
L
 Label Holders 119, 129
 Label Makers, Accessories
 119, 129
 Ladder Trucks 73
Ladders
 Double Stepladders 69-72
 Extension 70-73
 Multi-Purpose 72
 Platform 69-72, 75
 Rolling 75-77
 Single 70-72
 Stepladders 68, 71, 73, 77
 Stepstands 75, 77
 Stepstools 73, 75, 199
 Treble Stepladders 69-72
 Lamps 50, 189, 191
 Lanyards 74, 229
 Leak Diverters 219
 Leather Gloves 230
 LED Lamps/Light Bulbs 50
 Leg/Arm Bands, Traffic Control
 237
 Lever Pumps 58
Lids
 Drum 53, 60
 Waste Container 166-169
 Lift Tables 28-30
Lifters
 Drum 64-66
 Shop 30-31, 221
Lifting Equipment
 Aircraft Cables 35
 Beam Clamps 34
 Beam Trolleys 34
 Chain 38
 Clevis Grab Hooks 39
 Coupling Link 39
 Cranes 32-33
 Hoists 34, 40
 Jacks 47
 Jibs 33
 Lift Tables 28
 Lifting Clamps 34
 Magnetic Lifters 34
 Pallet Lifters 29-30, 33
 Pallet Trucks 1, 24-26, 29
 Self-locking Hooks 39
 Skid Lifts 29-30
 Sling Hooks 39
 Slings 35-37
 Slip Hooks 39
 Stackers 30-31, 221
 Light Bulbs 50, 189, 191
 Light Meters, Digital 245
Lighting
 Dock Lights 50
 Flashlights 189-190
 Floodlights 191
 Hand Lamps 191
 Headlights 189
 Lamps/Light Bulbs 50, 189, 191
 Penlights 190
 Task Lights 189
 Telescopic Lights 191
 Limited Use Clothing 235-236
 Line Striping Paint 243
Liners
 Drum 53
 Waste Container 169
 Liquid Measures 193
 Liquid Tip Markers 158
 Literature Displays 201
 Load Binders 47
 Load Indicators 40, 164
 Locker Room Benches 105
 Lockers 102-105
 Lockouts 104, 241
 Locks, Padlocks 100, 240
 Logistic Straps 51, 162
 Lubricating Equipment 193
 Lumber Carts 15
M
 Machine Stands 91
 Magnetic Lifters 34
 Magnetic Tags 119
 Mail Carts 201
 Mail Sorters 202
 Mailers 154
 Maintenance Platforms 74
 Markers 158, 230
 Marking Paint 243
 Marking Wands 243
 Masking Tape 156-157, 195
 Masks, Dust 227
Material Handling
 Box Trucks 16, 18-19
 Cargo Bars 47
 Dollies 17, 102, 136, 139
 Drywall Carts 15
 Forklift Checklist Kit 27
 Forklift Extensions 27, 65, 74
 Hand Trucks 1-6, 82
 Hoppers 21
 Lifting Equipment
 1, 24-26, 28-40, 47, 221
 Load Binders 47
 Lumber Carts 15
 Panel Trucks 14-15
 Pipe Trucks 14, 109
 Platform Trucks 7-10
 Semi-Live Skids 10
 Shop Carts
 11-14, 16, 128, 140, 146
 Tilt Trucks 20
 Wagons 9
Matting
 Anti-Fatigue 207-211
 Anti-Static 212
 Clean Room 212
 Entrance 206-207
 Runner 206-207
 Welding 211
 Measures, Liquid 193
 Measuring Cups 193
 Mesh Partitions
 44-45, 108, 112-113
 Mirrors 242
 Mixing Valves, Thermostatic 238
 Mobile Bins 131
 Monitor Mounts 200
 Mops 172
 Mounts, Monitor 200
Moving Supplies
 Moving Blankets 51
 Straps 2, 51, 162
 Tie-Downs 51, 219
 Muffs 229
 Multi-Purpose Ladders 72
N - O
 Nesting Bins 133, 135, 137
 Nets, Hair 235
 Nozzles, Garden Hose 182
 Nuts, Hex 45, 113
 Office Fans 185
 Office Seating 196, 198-199
Office Supplies
 Corkboards 203
 Filing Boxes 203
 Heel Grinders 212
 Literature Displays 201
 Markers 158, 203
 Monitor Mounts 200
 Paper Clamps 202
 Push Pins 203
 Staples 155
 Whiteboards 203
 Oil Cans 193
 Oily Waste Cans 216
 Open Wire Workstations 93
 Openers, Pail 61
 Order Picking Carts 13
 Outdoor Equipment,
 Grounds Maintenance
 181-182
 Overpack 220
P
Packaging
 Boxes 155
 Cable Ties 155
 Edge and Corner Protectors
 44, 46, 161
 Knife Blades 159
 Knives 159
 Mailers 154
 Moving Straps 2, 51, 162
 Packing List Envelopes 155
 Poly Bags 154, 158
 Poly Tubing 155
 Staplers 155
 Strapping 160-161
 Stretch Wrap 154
 Stretch Wrap Dispensers 154
 Tape 156-157, 159, 195
 Tape Dispensers 156
 Tie-Downs 51, 219
 Packing List Envelopes 155
 Padlocks 100, 240
Pads
 Furniture 51
 Spill Control 218-219
 Pail Dollies 63
 Pail Heaters 54
 Pail Inserts 53
 Pail Openers 61
 Pail Tipplers 67
 Pails 137
 Paint 195, 243
 Paint Brushes 195
 Paint Markers 158
 Paint Sticks 158
 Painting Supplies, Brushes 195
 Painting Supplies,
 Extension Poles 174
 Pallet Lifters 29-30, 33
 Pallet Pullers 27, 47
 Pallet Racks 107-108
 Pallet Servers 66
 Pallet Trucks 1, 24-26, 29
Pallets
 Plastic 110-111
 Spill Control 221-222
 Panel Trucks 14-15
 Panels, Bins 140
 Paper, Toilet 175
 Paper Clamps, Hanging 202
Partitions
 Column Protectors 46
 Gates 46, 172
 Guard Rails 44-45
 Perimeter Guards
 44-45, 108, 112
 Steel Mesh
 44-45, 108, 112-113
 Strip Curtain Doors 114-115
 Parts Cleaning 194
 Parts Storage Carts 146
 Parts Washers 194
 Pedestal Fans 184-185
 Penlights 190
 Perimeter Guards
 44-45, 108, 112
 Permanent Markers 158
Personal Protection
 Dust Masks 227
 Ear Muffs 228
 Ear Plugs 228
 Eyewear 224-225
 Faceshields 223
 Footwear 235
 Forearm Protectors 235
 Gloves 230-234
 Headwear 223, 235
 Hearing Bands 228
 Respirators 226-227
 Pharmaceutical Products,
 Hand Sanitizers 176
 Pillows, Spill Control 218
 Pins, Push 203
 Pipe Fittings, Kee Klamp® 116
 Pipe Racks 14, 109
 Pipe Trucks 14, 109
 Piping 116
 Platform Ladders 69-72, 75
 Platform Scales 164
 Platform Trucks 7-10
 Platforms 73-75
 Plunger Cans 194
 Pneumatic Piping 116
 Poly Bags 154, 158
 Poly Tubing 155
 Portable Blowers 180
 Portable Scales 163
 Posts, Crowd Control 244
 Pouches, Tool 81

INDEX

Power Tools, Saws 243
Pressure Washers 182
Pullers, Pallet 27, 47
Pumps 56-58
Push Brooms 174
Push Pins 203

R

Racks
Bar 109
Bin 92, 140-141, 148
Cantilever 109
Drum 67, 221
Pallet 107-108
Pipe 14, 109
Sheet 109
Skid Channel 108
Stacking 109, 151, 153
Threaded Rod 109
Radiant Heaters 187
Radiator Heaters 187
Rag Rugs, Spill Control 218
Rags 172
Rainwear 235
Ratchet Straps 51
Receiving Scales 164
Record Storage, Shelving 117
Recycling Containers 166-167
Reels 191-192
Respirators 226-227
Revolving Bins 149
Rinse Tanks 194
Risers, Dock 48
Rockers, Drum 63
Rolling Ladders 75-77
Rolls, Spill Control 218-219
Rotary Pumps 56
Rotators, Drum 63
Round Point Shovels 182
Runner Matting, Vinyl 206-207

S

Safety
Anti-Skid Cleats 243
Arm Protection 235
Cans 216
Crowd Control 244
Ear Protection 228
Eyewear 224-225
Faceshields 223
Fall Protection 74, 229
Fire Protection 216
First Aid 238-239
Flame Resistant Clothing 235
Flooring 243
Foot Protection 235
Hand Protection 230-234
Headwear 223, 235
High Visibility Clothing 237
Locking Systems 202
Lockouts 104, 241
Matting 207-212
Mirrors 242
Padlocks 100, 240
Pharmaceutical 176
Respirators 226-227
Spill Control 60, 63, 168, 174, 217-222
Traffic Clothing 237
Traffic Control 237, 243-244
Salt 181
Salt & Sand Containers 181
Salvage Drums 220
Sawhorses 73
Scaffolding 73-74
Scales
Bench 164-165
Counting 163
Crane 164
Dial 164-165
Floor 165
Hanging 164
Load Indicators 40, 164
Platform 164
Portable 163
Receiving 164
Utility 163
Weighing 163
Scoops 181, 193
Scrapers, Rubber 206
Screw Pin Anchors 38
Seals, Steel 160-161
Seating 105, 196-199
Security
Locking Systems 100, 202, 240
Lockouts 104, 241
Self-locking Hooks 39
Self-Retracting Lanyards 229
Semi-Live Skids 10
Service Benches 85-86
Service Writers 95
Shelf Bins 132-133
Shelf Carts 11-14, 128
Shelving Units
Bin 131, 141
Chrome 106, 126-127, 130
Stainless Steel 100
Steel 106, 117-118, 120-125, 141
Steel Wire 127
Widespan 117
Shields, Face 223
Shipping
Mailers 154
Moving Blankets 51
Packing List Envelopes 155
Pallets 110-111
Strapping 160-161
Shock Absorbing Lanyards 74, 229
Shoe Covers 235
Shop Carts 11-14, 16, 128, 140, 146
Shop Cranes 32
Shop Desks 95
Shop Lifters 30-31, 221
Shop Sweepers 179
Shovels
Round Point 182
Spill Control 219
Square Point 182
Showers, Emergency 239
Signs
Aisle 119
Floor 172
Traffic 41
Single Ladders 70-72
Sit/Stand Stools 197
Sit/Stand Computer Desks 200
Skid Channel 108
Skid Lifts 29-30
Sleeves, Vinyl 235
Sling Hooks 39
Slings
Chain 37
Drum Lifting 64
Nylon 36
Polyester 36-37
Wire Rope 35
Slip Hooks 39
Small Parts Bins 148
Small Parts Cabinets 143-146, 149-150, 152
Small Parts Cases 147
Snap Hook Anchors 35
Soap 173, 176
Soap Dispensers 176
Socks, Spill Control 218
Sorbents 174, 218-219
Sorters, Mail 202
Sound Level Meters, Digital 245
Speed Bumps, Traffic Control 244
Spill Control
Drain Seals 219
Drum Dollies 63, 168, 220-221

Drum Racks 221
Drum trays 60
Funnels 60
Kits 217
Leak Diverters 219
Overpack 220
Pallets 221-222
Salvage Drums 220
Shovels 219
Sorbents 174, 218-219
Spotters, Drum 62
Spray Adhesives 157
Sprayers
Lawn & Garden 182
Trigger 173
Square Point Shovels 182
Stackers 30-31, 221
Stacking Bins 129-134, 137, 140, 151
Stacking Dollies 136
Stacking Racks 109, 151, 153
Stands, iPad Holder 200
Staplers, Packaging 155
Staples, Office Staplers 155
Starcarts™ 18-19
Stepladders 68, 71, 73, 77
Stepstands, Steel 75, 77
Stepstools
Fiberglass 73
Polyethylene 75, 199
Stock Picking Carts 14
Stools 196-197, 199
Stop & Go Lights 50
Storage
Bar Racks 109
Bin Racks 92, 140-141, 148
Bin Shelves 131, 141
Cabinets 96-102, 142, 213-215
Cantilever Racks 109
Collapsible Containers 153
Distribution Containers 135-136, 138-139
Drawers 150
Food Handling Containers 137
Gas Cylinder Cabinets 215
Horizontal Sheet Rack 109
Jobsite Boxes 78-79, 83, 147
Lockers 102-105
Mobile Bins 131
Nesting Bins 133, 135, 137
Oily Waste Cans 216
Pallet Racks 107-108
Pipe Racks 14, 109
Plunger Cans 194
Poly Containers 52
Revolving Bins 149
Safety Cans 216
Salt & Sand Containers 181
Shelf Bins 132-133
Shelving Units 100, 106, 117-118, 120-127, 130, 141
Skid Channel 108
Small Parts Bins 141, 148
Small Parts Cabinets 143-146, 149-150, 152
Small Parts Cases 147
Stacking Bins 129-134, 137, 140, 151
Stacking Racks 109, 151, 153
Steel Bins 151, 153
Tanks 137
Threaded Rod Racks 109
Tool Bags 81-82
Tool Belts 81
Tool Boxes 82-83
Tool Cabinets 84
Tool Carts 83-85, 92
Tool Chests 78-80, 83-84
Tool Holders 81
Tool Pouches 81
Transfer Boxes 135

Straight Blade Connectors 188
Straight Ladders 70-72
Strainers, Drum & Pail 53
Strapping 160-161
Straps, Moving 2, 51, 162
Stretch Wrap 154
Stretch Wrap Dispensers 154
Strip Curtain Doors 114-115
Striping Machines 243
Structures, Bollards 45-46
Suits, Rain 235
Sweepers 179
Sweeping Compounds 174
T
Tables
Changing 175
Folding 203
Lift 28-30
Work 91
Tachometers 245
Tags
Key 202
Magnetic 119
Tanks
Rinse 194
Storage 137
Wash 194
Tape
Anti-Skid 243
Bag Sealing 159
Barricade 243
Box Sealing 156
Double Sided 156
Duct 157
Electrical 157
Filament 156
Glow in the Dark 243
Masking 156-157, 195
Tape Dispensers 156
Tarpaulins 51
Task Chairs 198
Task Lights 189
Task Seating 196-199
Task Stools 196-197, 199
Telescopic Lights 191
Tensabarriers 244
Thermometer/Hygrometers 245
Thermometers 245
Thermostatic Mixing Valves 238
Threaded Rod Racks 109
Thumb Tacks 203
Tie-Downs 51, 219
Ties, Cable 155
Tilt Trucks 20
Tilters, Drum 57, 63
Time Clocks 204
Tippers, Pail 67
Toilet Paper 175
Tool Storage
Bags 81-82
Belts 81
Boxes 82-83
Cabinets 84
Carts 83-85, 92
Chests 78-80, 83-84
Holders 81
Jobsite Boxes 78-79, 83, 147
Pouches 81
Tops, Drum 53, 60
Tote Boxes 129
Towels, Hand 175
Trades Carts 11
Traffic Control 237, 243-244
Traffic Safety Clothing 237
Traffic Signs 41
Trailer Jacks 47
Transfer Boxes 135
Transfer Pumps 56
Trash Cans 167-170

Trays, Drum 60
Trestle Stepladders 69-72
Trigger Sprayers 173
Trolleys, Beam 34
Trucks
Appliance 2-3
Box 16, 18-19
Drum 62-63
Hand 1-6, 82
Ladder 73
Pallet 1, 24-26, 29
Panel 14-15
Pipe 14, 109
Platform 7-10
Tilt 20
Tumblers, Drum 67
Two-Way Tape Dispensers 156
U - V
Upenders, Drum 61
Upright Protectors 45
Utility Carts 11-12, 16, 128
Utility Knives 159
Utility Scales 163
Vacuums 177-180
Valves
Drum 59
Gate 59
Water Mixing 238
Vents, Drum 59
Vests 237
Vises, Bench 192
Visors 223
W
Wagons 9
Wall Clocks 204
Wall Mounted Fans 184-185
Wands, Marking 243
Wash Tanks 194
Washroom Cleaners, Disinfectants 173
Washroom Products 175
Waste Container Caddy 168
Waste Container Dollies 166, 168
Wastebaskets 169
Water Filters 205
Water Fountains 205
Water Preservatives 238
Weighing Scales 163
Welding Supplies, Matting 211
Wet Mops 172
Wheel Chocks 41-42
Wheel Risers 48
Whiteboard Markers 203
Whiteboards 203
Winter Lined Gloves 230, 232
Wipes 172, 175
Wires, Bonding & Grounding 55
Work Clothing, Aprons 235
Work Lights 191
Work Platforms 73, 75
Work Tables 91
Workbenches 86-94
Workstations
Accessories 93-94
Computer 200
Mail 202
Open Wire 93
Service Benches 85-86
Shop 95
Work Tables 91
Workbenches 86-94
Wrenches
Bung 61
Drum 61
Wringers 171-172



BUILT KLETON

TOUGH



Kleton builds quality and dependability into all of their products. The same is true of products specially built to meet your specifications. Look throughout the catalogue for the *Kleton Custom Symbol* indicating which products can be customized to meet your specific needs.



Look for this symbol throughout the catalogue indicating which products can be customized to meet your specific needs.

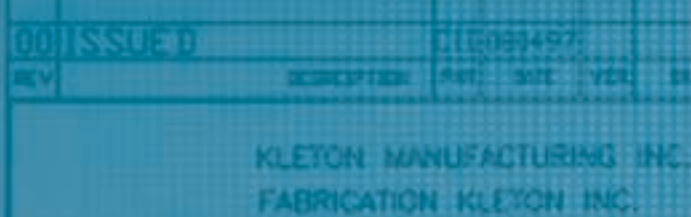

KLETON

*Canada's Leading
Material Handling Supplier*



MOVE

RAYMOND, BT & OTHER EQUIPMENT

BATTERIES & ACCESSORIES

RENTALS & RENEWED

DOCKS & DOORS



MANAGE

PARTS & SERVICE

LEASING & FINANCING

COMPLETE FLEET®

TELEMATICS



STORE

RACKING STORAGE & PLATFORMS

ENGINEERING & PROJECT MANAGEMENT

USED RACKING-SHELVING & BUYBACKS

STORAGE SYSTEMS



PROTECT

IDEAL MAINTENANCE®

FIXED-PRICE MAINTENANCE PLANS

TRAINING

EXTENDED WARRANTY

RAYMOND JOHNSTON EQUIPMENT

5990 Avebury Road, Mississauga,
Ontario L5R 3R2
P: (905) 712-6000 • F: (905) 712-6002
TF: (800)-668-5586
www.johnstonequipment.com



PLEASE CALL
YOUR REPRESENTATIVE
FOR MORE INFORMATION



ADHERE YOUR BUSINESS CARD
TO THIS LOCATION

